

BRECOflex CO., L.L.C.

High Precision Drive Components

The World Leader In Polyurethane Timing Belts

Product GUIDE

Innovation.
Precision.
Dedication.

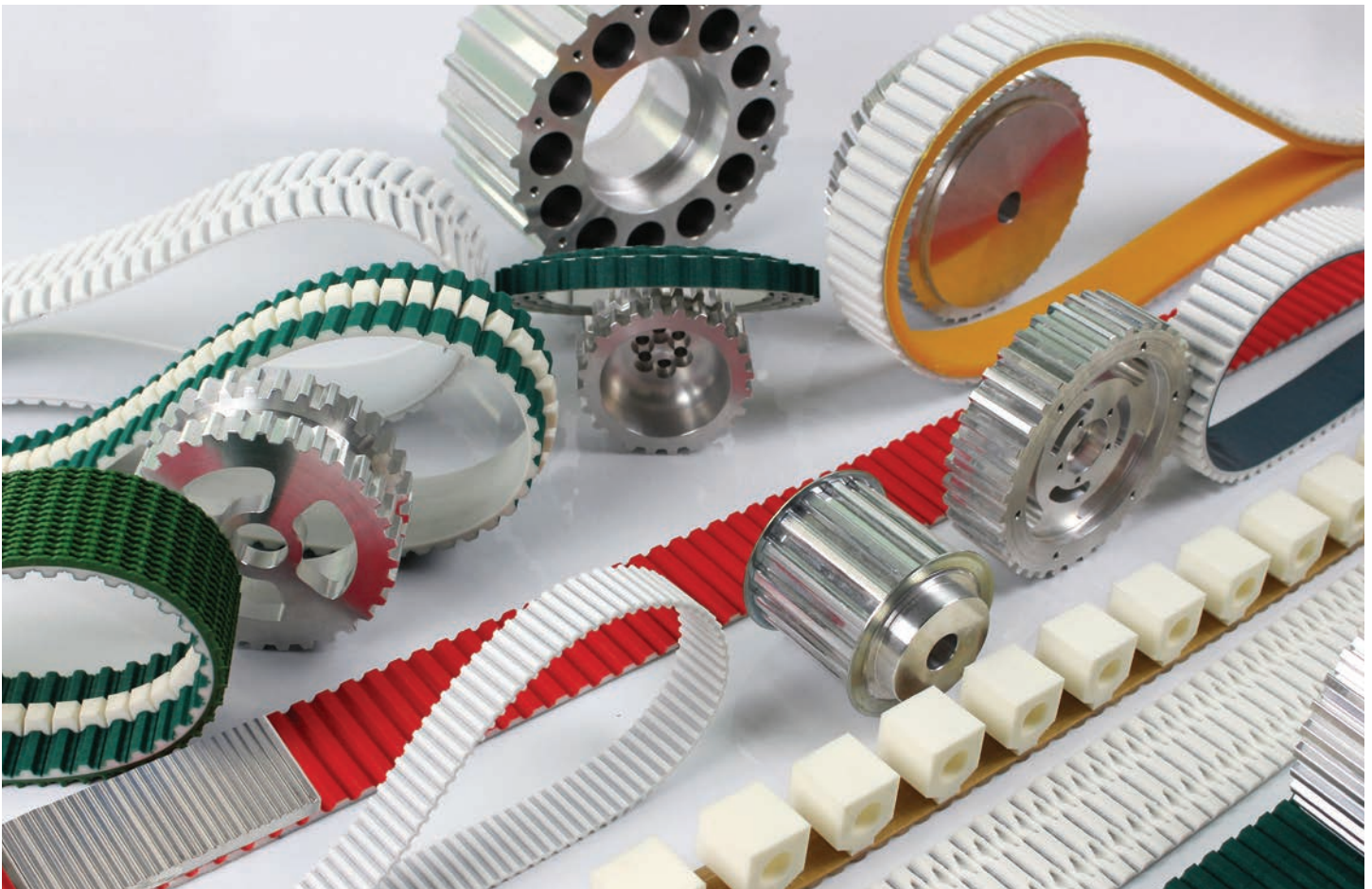



BRECOflex CO., L.L.C.

“ We strive to provide our customers with outstanding products, engineering support, and customer service to meet their highest expectations. ”

about us

BRECOflex CO., L.L.C. High Precision Drive Components

was founded in 1989 with an unwavering commitment to excellence in the products we bring to the market, the customers we serve, and the people we employ who are dedicated to meeting our customers' highest expectations. Our products offer superior quality and innovative features to meet the most challenging design requirements.

BRECOflex CO., L.L.C. translates the customers' needs into new and expanded product lines. We partner with our customers in providing unique solutions and superior service for the long term. You can rely on our free technical support from the initial design phase through the after-sales service.

BRECOflex CO., L.L.C. polyurethane timing belts and drive components are specified by more OEM's worldwide than any other brand and are used in many diverse industries that utilize conveying, driving, indexing, linear drive and power transmission applications. We are ISO 9001 certified in recognition of our quality management system and our conformance with ISO's internationally accepted standards of quality assurance.



THE PERFECT COMBINATION

Strength *and* Flexibility

As the world leader in the polyurethane timing belt industry, we set higher standards with our state-of-the-art products, which are scientifically designed for undeviating quality. We manufacture our timing belts with extremely wear resistant polyurethane and high tensile braided steel tension members. For special applications, Kevlar® and stainless steel tension members are available. High-grade materials and sophisticated manufacturing know-how form the basis of our extremely accurate and reliable timing belts, pulleys and accessories.

BRECOflex CO., L.L.C. offers the most comprehensive product range with more than 100 tooth configurations and new leading edge timing belt designs such as ARC-Power®, ATN®-Convertible Timing Belt Systems and *move-series*®. Our applications engineers provide design assistance to ensure the best product selection and correct sizing of your timing belts.

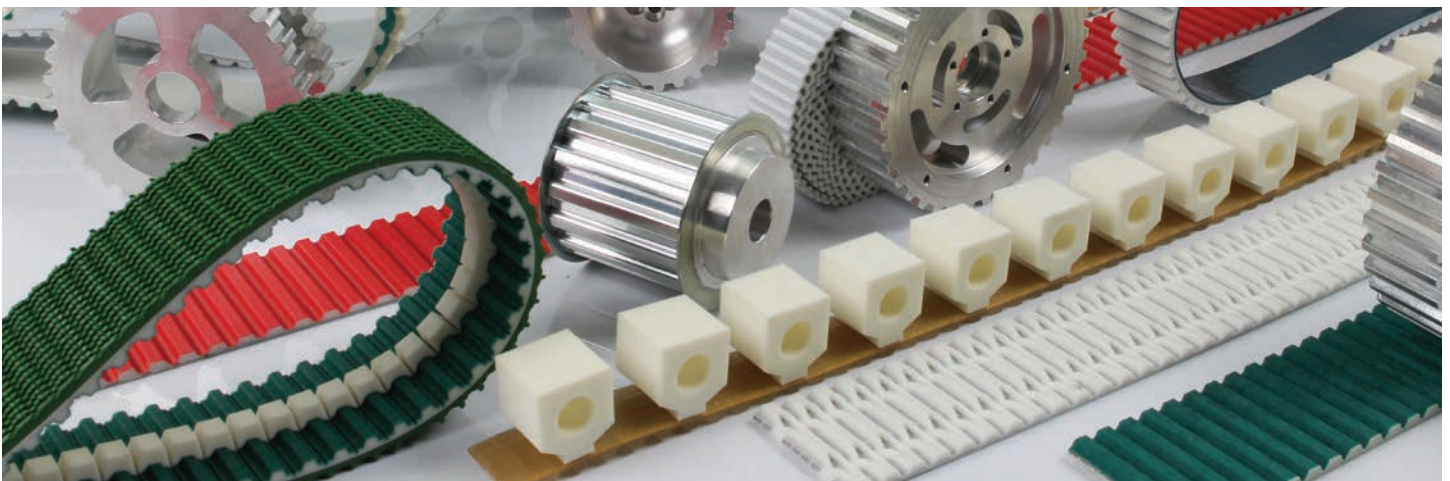
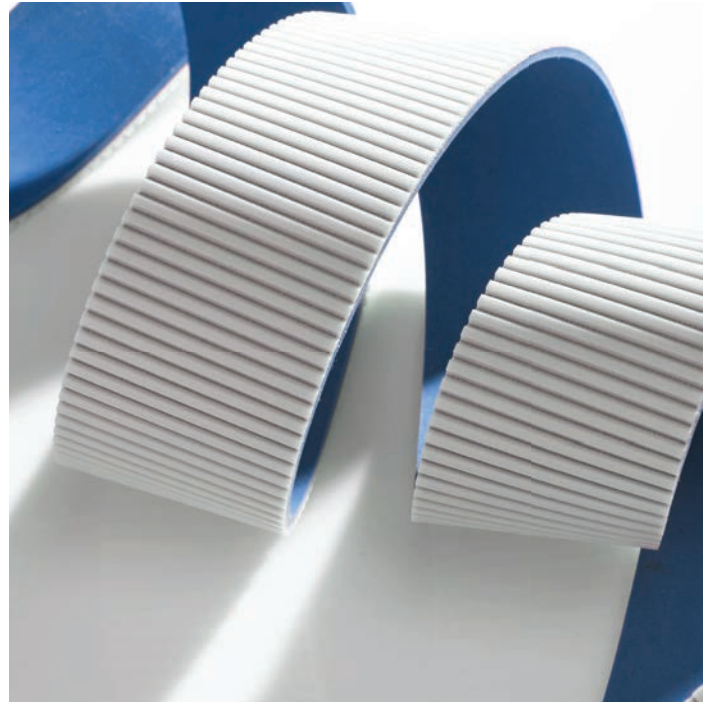

POLYURETHANE TIMING BELT

Options *and* Specialty Belts

In addition to our superior polyurethane timing belts in metric and imperial pitches, we have many belting options to suit a multitude of special applications. Free engineering support and design assistance is always available to ensure that you choose the products that will yield the best performance and longest service life.

BACKINGS AND COVERS

Backings add essential functionality to your timing belt. Choose from dozens of different backings with varying characteristics to suit your needs.

PROFILES

For conveying and indexing applications, BRECOflex CO., L.L.C. offers over 4,000 profile injection molds in stock. Custom modification of both belt and profile are available. For flexibility, our exclusive ATN® Convertible Timing Belt System allows you to attach, reconfigure and remove profiles without removing the belt from the drive.

SPECIAL MACHINING

BRECOflex CO., L.L.C. can custom machine timing belts including lateral and longitudinal machining, back grinding, edge grinding, perforating, vacuum holes, tooth removal and more.

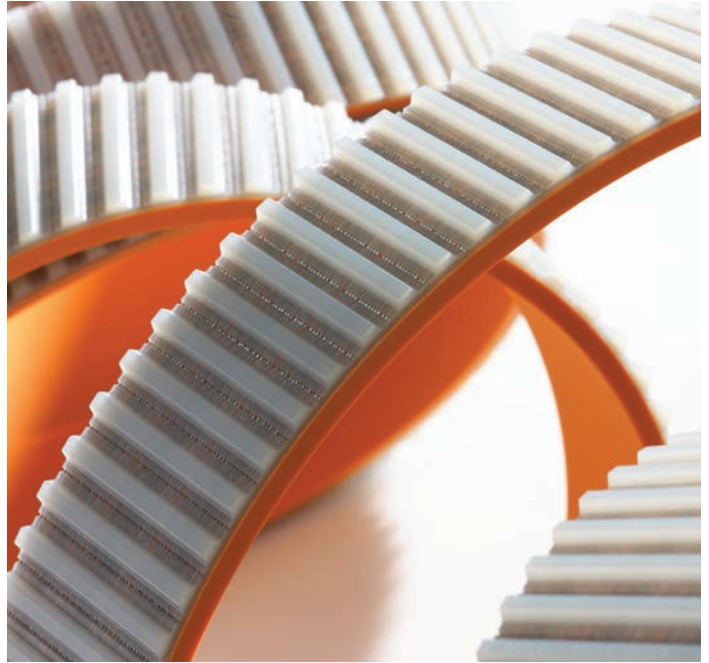

MOVE-SERIES

Move-series® is the new generation of high precision timing belts available in open-ended for linear drives and truly endless BFX for power transmission applications. They offer up to 75% more tensile strength and 30% higher transmittable force than standard polyurethane timing belts of the same size. When combined with our zero backlash drive pulley, no belt comes close to the precision of move-series® timing belts.

FDA APPROVED

BRECOflex CO., L.L.C. offers FDA approved polyurethane timing belts in a wide selection of pitches and widths for use in food conveying and processing applications. For customers who require belts for use in wash-down applications, we recommend BRECOprotect®. BRECOprotect® features fully encapsulated carbon steel tension members in a special hydrolysis and oil resistant blue polyurethane especially designed for food inspection vision systems.

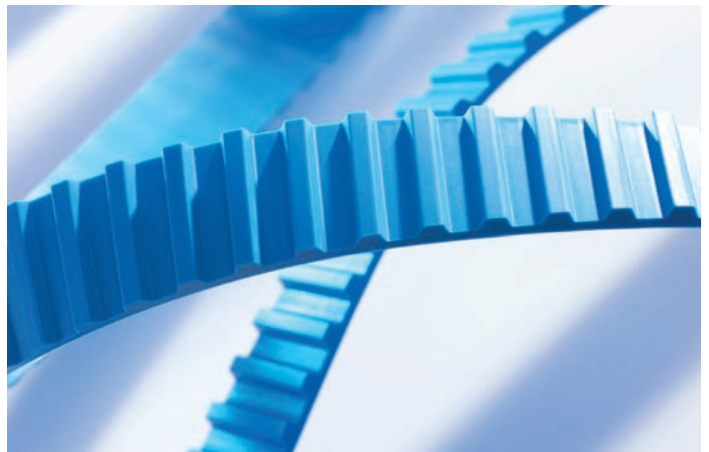

PULLEYS, ACCESSORIES, AND Additional Options

Our ability to custom manufacture pulleys in the USA enables us to offer the fastest pulley lead-time in the industry. BRECOflex CO., L.L.C. can meet any custom requirement and guarantees perfect meshing of timing belt and pulley when our products are used together.

STOCK PULLEYS

Stock pulleys come with a standard pilot bore and zinc plated steel flanges. In most cases, stock pulleys are available for immediate delivery and can ship the same day they are ordered.

CUSTOM MADE PULLEYS

We guarantee that custom aluminum pulleys will ship in eight days or less. Custom designs include but are not limited to several types flanges, TL bushing bore, hubs, mounting holes, set screws, threaded holes for QD bushings, keyways, snap ring groove, counter bore, lightening holes, bolt holes, and self-tracking grooves.

ALTERNATE PULLEY MATERIALS

In addition to aluminum, we can manufacture any pulley in steel, stainless steel and Delrin. Surface finishes include anodized and hard anodized, black oxide, zinc-plated, chromate and nickel-plated.

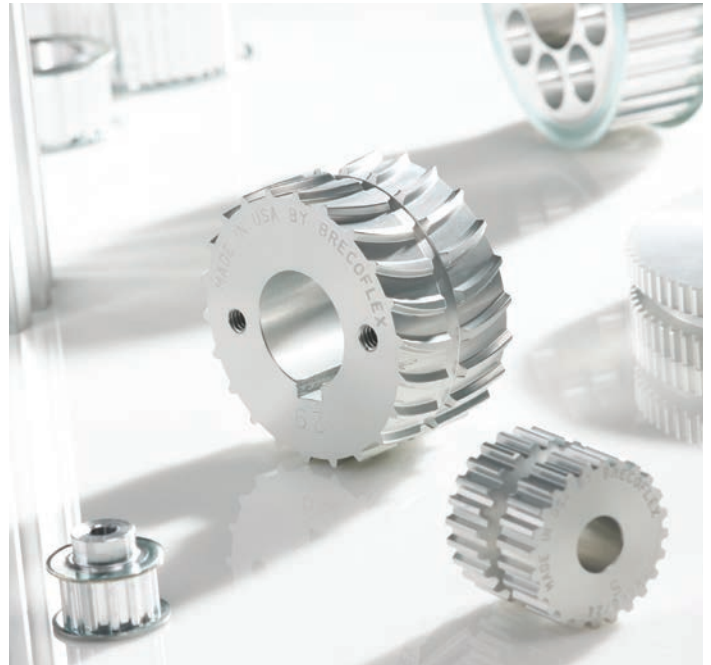

TENSION METER

Our easy to use SM5 Tension Meter will accurately measure the static tension of any belt and is highly recommended for ensuring peak performance of your drive.

FIELD WELDER

The BRECOflex CO., L.L.C. Field Welder allows the end-user to weld open-ended timing belts on-site in only 30 minutes yielding the same strength of factory supplied timing belts.

CLAMPS AND TENSIONING CLAMPS

Clamps are used to attach the ends of an open-ended timing belt. If you require the ability to apply pretension, then tensioning clamps are available in six different types including standard, interchangeable and high load.

TENSIONERS

Use tensioners for applications where adjustment of pretension is required after final installation. All stock tensioners are made of aluminum with a steel shaft. Contact us for custom specifications.



Esband®

Truly Endless Woven Flat Belts



Esband® truly endless woven homogeneous flat belts are manufactured without joints or splices for high-performance drive and conveying applications. These unique flat belts offer many advantages and benefits for demanding drive and conveying machinery and equipment. Esband® truly endless belt technology outperforms conventional joined flat belt designs.

PRODUCTS AND PROPERTIES

- Drive belts
- Standard conveyor belts
- Weighing belts
- Vacuum conveyor belts
- Food transport belts
- High temperature belts
- Specialty belts (to customer specifications)
- Conveyor belts for paper transport
- Coating materials for timing and multi-V belts

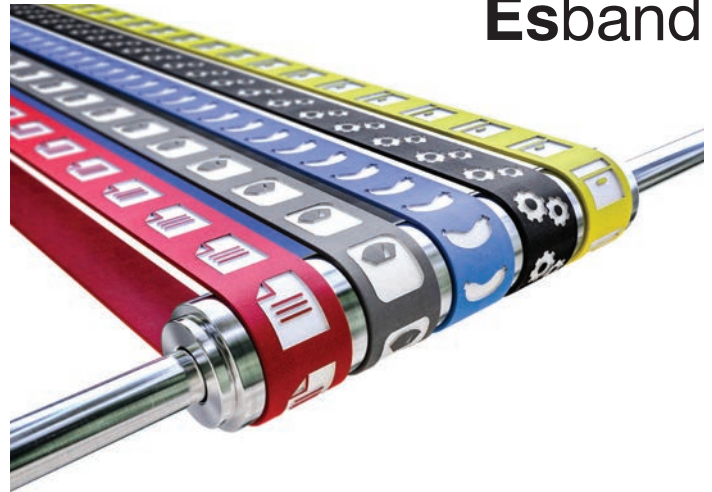
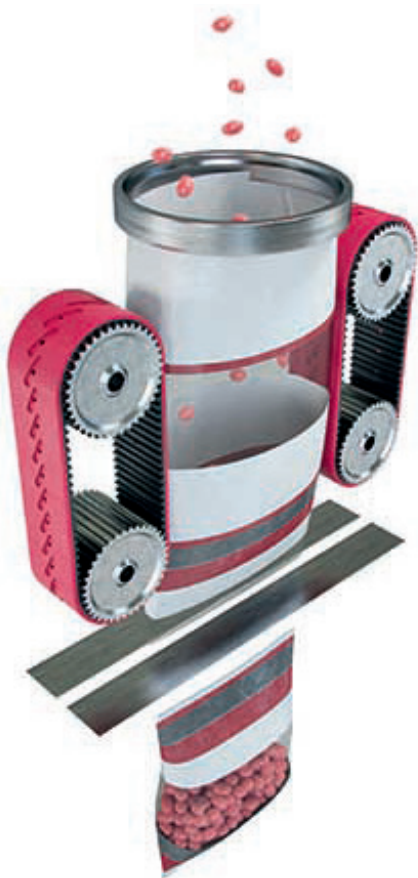

CARCASS MATERIALS

Esband® flat belt carcasses are produced in truly endless form by using high tech weaving machines. These specialty carcasses are the belt bases for further processing, coating and treatment. Various carcass materials are used for specific belt characteristics.

COATING MATERIALS

All Esband® coatings are applied as endless covers so belts may be run in either direction. In addition, polyurethane timing belts can be coated using the same materials. Esband® offers many materials tailored to meet application requirements such as FDA approval, wear resistance, high temperature, and excellent machinability.

ADVANTAGES

- Highly efficient (> 98.5%)
- Belt speeds of 150 m/s possible
- Long service life
- High loads possible
- Good dynamic characteristics
- Improved shock absorption
- Can be used as overload protection

POLYURETHANE TIMING BELT

Belt Pitch Chart (To Scale)

AT-Series

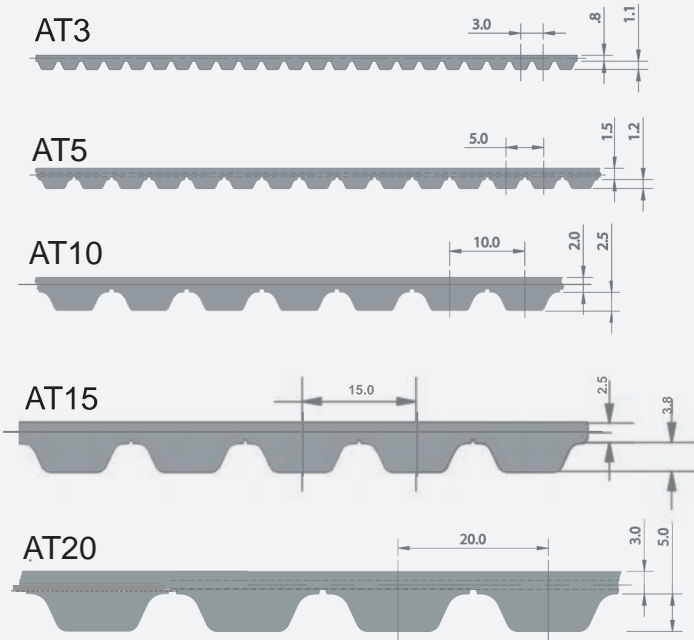

T-Series

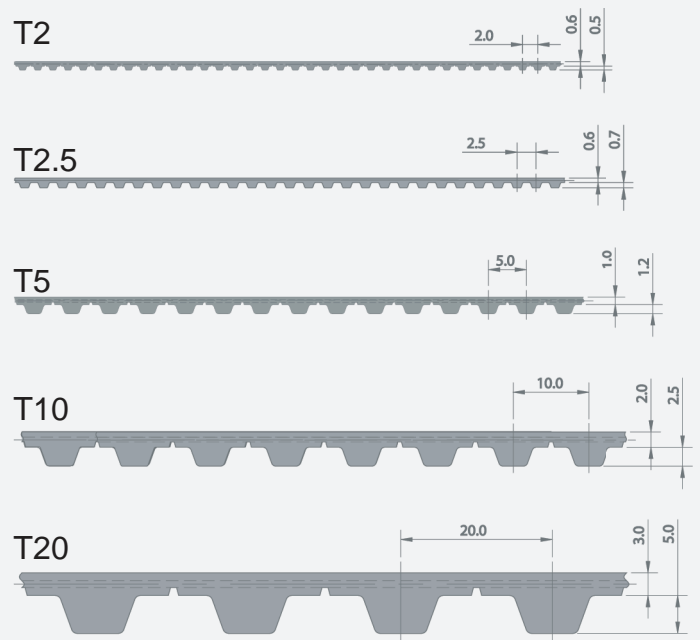

Imperial-Series

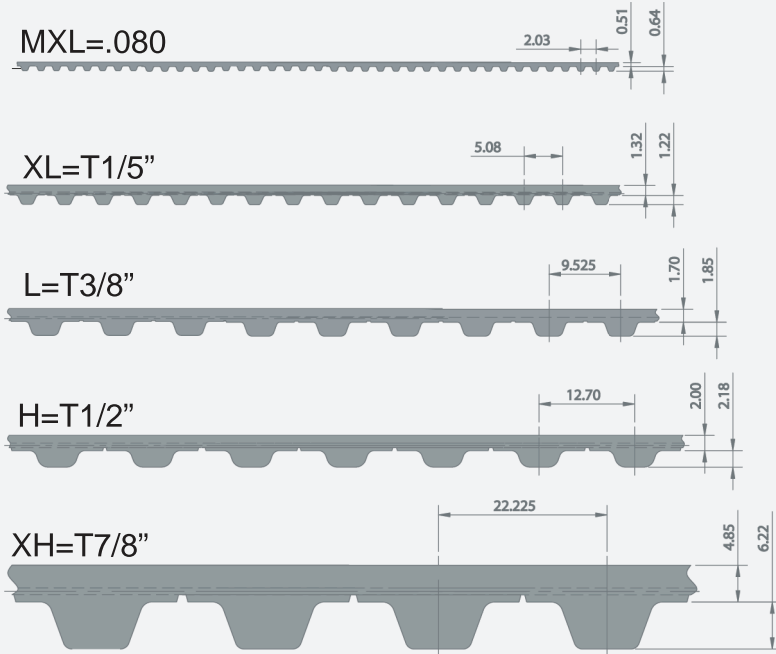

HTD-Series

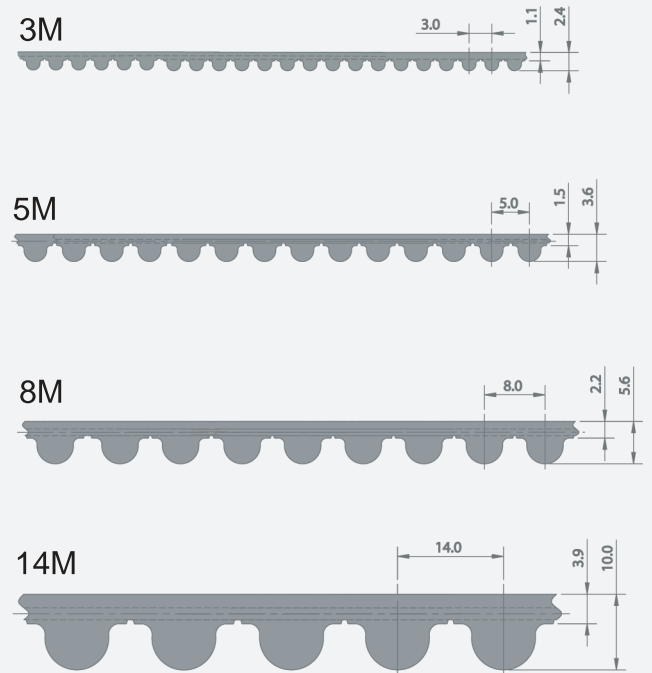



BRECOflex CO., L.L.C.

High Precision Drive Components

Contact Us

222 Industrial Way West • Eatontown, NJ 07724

Toll Free: 1-888-463-1400 • Tel: 732-460-9500 • Fax: 732-542-6725

www.brecoflex.com • e-mail: info@brecoflex.com

Regional Sales Offices:

| | | | | | | | |
|------------|----------------|--------------|----------------|--------------|----------------|----------------|-------------------|
| Atlanta | (770) 317-8745 | Dallas | (214) 476-5650 | Miami | (770) 317-8745 | Richmond | (804) 387-5760 |
| Bay Area | (661) 713 0121 | Denver | (303) 470-7226 | Milwaukee | (908) 461-6995 | Seattle | (503) 781-3631 |
| Baltimore | (804) 387-5760 | Detroit | (908) 433-0036 | Minneapolis | (908) 461-6973 | Salt Lake City | (303) 470-7226 |
| Boston | (603) 496-5833 | Ft. Wayne | (908) 461-1168 | Nashville | (732) 757-6647 | San Antonio | (214) 476-5650 |
| Buffalo | (412) 600-5632 | Grand Rapids | (908) 461-1168 | New York | (732) 829-7773 | Toledo | (908) 433-0036 |
| Charlotte | (908) 461-3937 | Houston | (214) 476-5650 | Philadelphia | (732) 829-7773 | Toronto | (416) 476-7107 |
| Chicago | (908) 461-6995 | Indianapolis | (908) 461-2344 | Phoenix | (480) 961-3846 | Mexico City | +52 1 55 45335835 |
| Cincinnati | (908) 461-2344 | Las Vegas | (480) 961-3846 | Portland | (503) 781-3631 | Monterrey | +52 1 55 40840778 |
| Cleveland | (412) 600-5632 | Los Angeles | (661) 713-0121 | Pittsburgh | (412) 600-5632 | Guadalajara | +52 1 55 40949053 |

Copyright 2018 BRECOflex CO., L.L.C. • BRECO®, BRECOFLEX® & ATN® are registered trademarks of BRECO Antriebstechnik GmbH • ARC-POWER® is a registered trademark of BRECOflex CO., L.L.C. • Kevlar® is a registered trademark of DuPont Patents Pending • ESBAND® is a registered trademark of Max Schlatterer GmbH & Co. KG Patents Pending. Specifications are subject to change without prior notice.

All recommendations for the use of the products described herein and all other data or information set forth in this publication, whether concerning such products or otherwise, are furnished without any guarantee, warranty representations or inducement of any kind whether expressed or implied, including but not limited to warranties of merchantability and fitness for a particular purpose. BRECOflex CO., L.L.C. expressly disclaims liability under any theory, including without limitation, contract negligence, misrepresentation or breach of any obligation relating to the recommendation, data or information set forth herein. Readers and customers are encouraged to conduct their own test before using any product. Read its label and all related instructions. BRECOflex CO., L.L.C. reserves the right to make changes in the technical and dimensional specifications of its products without prior notice. Responsibility for expenses incurred as a result of product changes or discontinuance of a product lies solely with the purchaser.