

- EP – FD metering valve 295223 with back flow effect
- Suitable for media of up to 10,000 mPas and thixotropic fluids
- Especially suitable for omniFIT FD 10 surface sealants
- Maximum product pressure 4 bar
- Components in contact with product are made of PTFE / FKM
- Manual stroke adjustment via fine-tuning facility in steps 0.01 mm



The metering valve is a pneumatically actuated piston valve with a conical-shaped seal seat and integrated FKM O-ring. By admitting air of at least 4 bar (normally 6 bar) into the pneumatic cylinder, the valve opens. It is shut by turning off the air via spring pressure. The valve body houses a PTFE diaphragm which protects the metering agent against the metallic components of the pneumatic

cylinder. Dispensing of the adhesive to the metering point is carried out via the metering tip.

The valve's body, as well as all components in contact with the product, are made of Teflon /FKM. Thus, the problem of hardening in the valve chamber can be avoided.

Technical data:

Compressed air consumption	4 to 6 bar
Product pressure	0.1 to 3.8 bar
Components in contact with product	PTFE / FKM
Sealant material	Viton B
Shortest open and shut time	0.03 sec.
Actuation via	3/2-way pneumatic valve
Weight	275 grams

Dimensions:

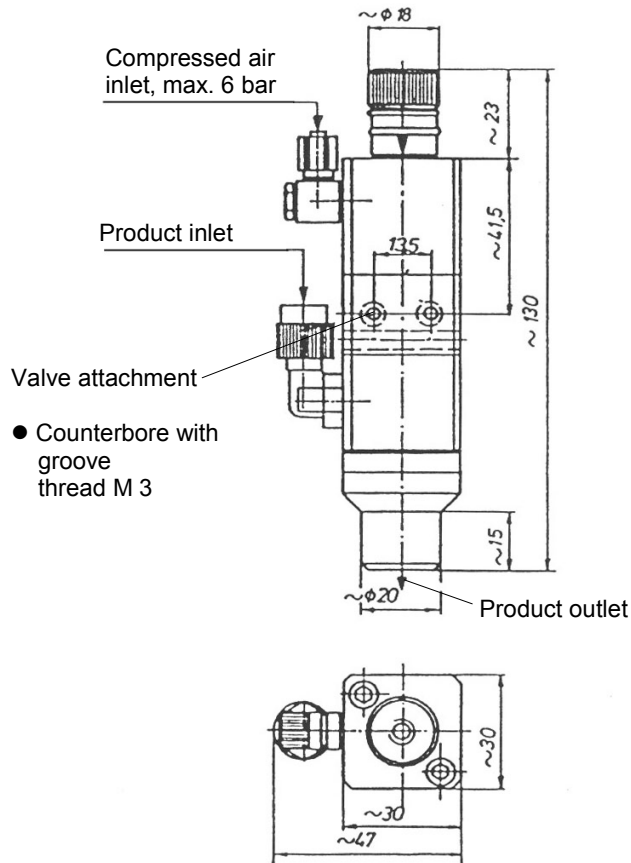

Ordering data:



Article/Nomenclature

Material no.

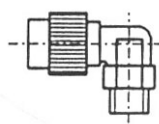

Metering valve EP-FD with back flow effect

295223

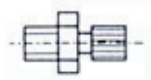
Accessories:

	Article/Nomenclature	Material no.
Inlet side:		
	Compressed air hose Ø 4/6 mm material: blue PE	417400352
	Product hose Ø 4/6 mm material: black PE, soft	417400353
	Product hose Ø 4/6 mm material: PE	417400301
	Product hose Ø 6/8 mm material: transparent PE	417400310
	Product hose Ø 4/6 mm material: PTFE	417400215
	Product hose Ø 6/8 mm material: PTFE	417400224
	Angled screw connection R 1/8" Ø 6/8 mm, material: PVDF	415101809
	Spiral hose	417400561
Outlet side:		
Hose connections:		
	Hose Ø 4/6 mm material: PE	417400301
	Hose Ø 6/8 mm material: PE	417400310
	Hose Ø 4/6 mm material: PTFE	417400215
	Hose Ø 6/8 mm material: PTFE	417400224
		Straight screw connection R 1/8" Ø 4/6 mm, material: PVDF
	Straight screw connection R 1/8" Ø 6/8 mm, material: PVDF	415101963

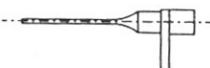
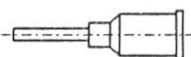

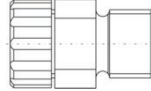
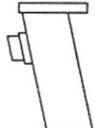
Accessories:

	Article/Nomenclature	Material no.
	Screw-in nozzles, PTFE:	
	Nozzle Ø 0.8 mm	39520719
	Nozzle Ø 1.0 mm	39520720
	Nozzle Ø 1.3 mm	39520714
	Nozzle Ø 1.6 mm	39520715
	Nozzle Ø 2.0 mm	39520712
	Nozzle Ø 2.5 mm	39520721
	Metering tips, soft:	
	Metering tip, size 0	415701145
	Metering tip, size 0.5	1...5232
	Metering tip, size 1.0	415701147
	Metering tip, size 1.0, Luer-Lock	415701148
	Metering tip, size 1.5	295250
	Metering tips, metallic:	
	Metering needle	
	ID = 1.62 mm length 12,7 mm, aluminum	415703219
	ID = 1.37 mm length 12,7 mm, aluminum	415703220
	ID = 1.00 mm length 12,7 mm, pink	415703221
	ID = 0.78 mm length 12,7 mm, brown	415703222
	ID = 0.50 mm length 12,7 mm, green	415703223
	ID = 0.40 mm length 12,7 mm, black	415703226
ID = 0.31 mm length 12,7 mm, light blue	415703227	
	Adaptor Luer-Lock for metering tips and metallic metering tips	415703251
	Connection clamp adapter PTFE R 1/8"-external, for metering tip extensions and metering tips PE soft	295253
	Grab handle piece, electric	295312
	Grab handle piece, pneumatic Adaptor plate is required in addition	1...9064 on request

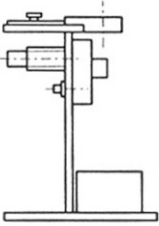
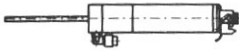
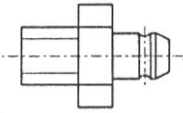
Accessories:

	Article/Nomenclature	Material no.
	Screw fix and seal unit completely assembled	on request
	Rotary spray gun Integra Ø 30; 9,000 rpm	295056
	Rotary spray gun Multi Ø 30; 9,500 rpm	295037
	Concentric nozzle Size Ø 2 mm to Ø 30 mm	

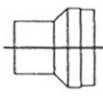
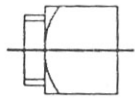
Spare parts:

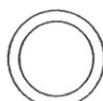
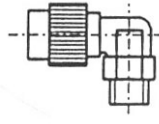
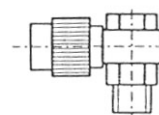
	Article/Nomenclature	Material no.
	Head piece	39522301
	Lower part of diaphragm chamber	39522302
	Tappet	39522303
	Aluminum ring	39520704
	O-ring Ø 10 x 2.0 mm, Buna	417002078
	O-ring Ø 18 x 3.0 mm, Buna	417002173
	O-ring Ø 5 x 1.5 mm, EPDM	417001026
	O-ring Ø 15 x 1.5 mm, Viton	417003049
	Angled screw connection R 1/8" Ø 4/6 mm, material: PVDF	415101810
	Swivel screw connection M5 Ø 4/6 mm, material: aluminum	415100903