

Technical
Information and
Product Range

COOL-FIT ABS™

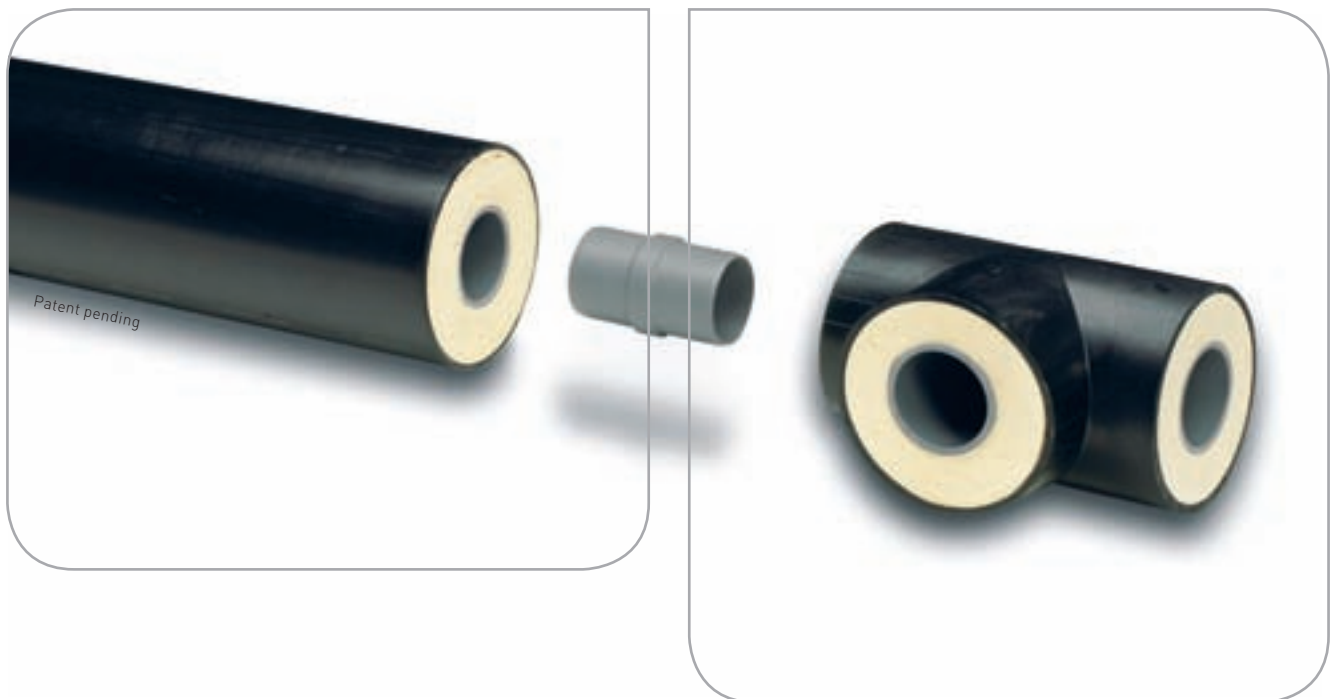

+GF+

GEORG FISCHER
PIPING SYSTEMS

GF Piping Systems

Throughout the world everyone demands a secure supply of clean water. GF Piping Systems is meeting this challenge by providing complete piping systems suitable for safe operation in virtually all environments. We have developed systems comprising of pipe, fittings, valves, and measuring and control devices in high quality corrosion resistant thermoplastics for the transport of not only clean water, but also gas and other industrial media.

Whether installed above or below ground, in industrial, commercial or domestic applications, GF Piping Systems provides a solution.

Innovation and technology.

GF Piping Systems, through focussed research, is continually developing new products and technologies, setting new global standards in quality and performance for our customers.

All from one source. GF Piping Systems covers the growing demand for complete solutions from a single source in a wide range of applications.

Quality management. All system components are stringently tested in accredited test laboratories. Management and production procedures are certified to ISO 9001 and ISO 14001 to guarantee form, fit, function and compliance in whatever application they may be used throughout the world.

Sales and service – worldwide.

Our local sales companies and representatives in over 100 countries provide „one stop“ shopping, including planning support, training and product availability.

Facts and Figures. GF Piping Systems with its 3200 employees achieves an annual turnover of about CHF 800 million. GF Piping Systems is part of the Georg Fischer Corporation, which was founded in Schaffhausen, Switzerland in 1802. Today the corporation has more than 13,000 employees and an annual turnover of CHF 3.3 billion.



→ your benefits

- technological expertise
- „one stop“ shopping
- premier quality and performance
- system solutions
- know-how and experience
- local support

COOL-FIT ABS

Contents	Page
General Information	4
Top Quality: Minimum On Site Time	5-7
System Advantages: Your Benefit	8-9
COOL-FIT ABS Pipe Technical Details	10
COOL-FIT ABS Fittings Technical Details	11
Accessory Equipment	12
Accessory Equipment for Solvent Cement Jointing, Reducing Diameters and End Caps	13
COOL-FIT ABS Reducing Diameters	14
Pressure-Temperature Parameters	15
Technical Data	16
General Comments	16
Pressure Drops	17-18
Pipe Support Distances	19
Pipe Supports and Fixed Point	20
Flexible Length	21
Plastic to Metal Connections	22
Measuring Equipment	22
Measuring Equipment, De-Venting and Curing Time	23
Pressure Testing and Insulation	24
Under-Ground Use and Storage	25
Flammability	26
ABS Metric Piping System Specification	27
COOL-FIT ABS Pipe and Fittings Specification	27
Contents Product Range	28-39
Pipe and Fittings (black and white)	28-33
Accessory Equipment	34-39
Instructions for Solvent Cement Jointing of ABS	42-45
ABS Tangit and Cleaner, Gap Filler, Sealing Tape: Amounts required	46
Instruction for Solvent Cementing COOL-FIT ABS	47
Jointing technique: Pipe preparation	48-49
Instruction for Insulating the Gap	50
ABS Product Range	51

The technical data is not binding and not an expressly warranted characteristic of the goods. It is subject to change. Please consult our General Conditions of Supply.

General Information

COOL-FIT ABS is a complete system solution for secondary cooling and refrigeration piping systems. The system is based on the tried and tested ABS plastic system from GF Piping Systems which contains pipe fittings valves and transition fittings, now with the option for pre-insulated pipe and fittings with outer jackets in either black or white. You can adapt the system solution to your particular needs. For example white pre-insulated for food production halls or standard plastic pipe with control valves for pump houses or OEM chillers.

Refrigeration and Cooling plants in general using plastic pipe as the carrier system offer complete corrosion resistance and a cost effective solution compared to traditional metal materials.

Pipe

The ABS pipe and fittings are available in 3 versions.

- standard un-insulated, to be insulated on-site with traditional insulation
- pre-insulated with black PE jacket
- pre-insulated with white PE jacket

Fittings

A complete range of fittings compatible to the pipe is also available either as standard or as insulated with either white or black outer jackets.

The ABS range contains shut-off valves, control valves, automated valves pneumatic and electrical as well as a complete range of transition fittings for metal to plastic connections. See standard GF Piping Systems ABS literature for the complete range available in dimensions d16 to d315mm.

GF Piping Systems ABS Raw Material

ABS is a material used in a wide range of general engineering applications from general housings for vacuum cleaners for instance to car bumpers.

GF Piping Systems ABS raw material has been specifically developed for long-life pressure bearing piping systems. For physical properties see ISO 15493 and GF Piping Systems literature Fi 9030, pages 32–34.

Acrylonitrile Butadiene Styrene (ABS) is a styrene acrylonitrile copolymer grafted to polybutadiene to produce a homogeneous material with excellent impact and low temperature characteristics. ABS is halogen free with a low thermal conductivity and non-toxic. GF Piping Systems ABS has a range of internationally recognised approvals. Please ask if you require any details regarding approvals or raw material properties.

PUR Insulation

COOL-FIT ABS pre-insulated pipe and fittings are delivered ready to install using high density PUR > 45 kg/m³ as the insulation material, the PUR is CFC free and recyclable.

Jacket Pipes in White and Black

The outer jacket in either black or white is manufactured from high density polyethylene (PE). PE offers extremely good impact resistance and a good resistance to oil splashes and grease or other external contamination. The PE is smooth, non-corroding and thus easy to clean with a long life-span.

White PE offers an aesthetic and hygienic alternative for internal systems for instance in supermarkets or food production halls.

Black PE is UV resistant and thus ideally suited to outdoor applications and for general use.

Typical Working Conditions

With working temperatures ranging from –50 °C to +40 °C for pre-insulated and –40 °C to +60 °C for the standard ABS system with a maximum working pressure of 10 bar (water at +23 °C) COOL-FIT ABS.

Typical Mediums

COOL-FIT ABS can be used for example with the following mediums:

- chilled water and general water
- salt solutions
- glycol solutions
- alcohol solutions

For compatibility of ABS to non-water mediums please consult GF Piping Systems and see page 15.

Note: COOL-FIT ABS is not for use with primary gases such as Ammonia, Propane, R407, R22, and also not for use for compressed air systems.

COOL-FIT ABS

Top Quality: Minimum On Site Time



Top Quality: Minimum On Site Time

Pre-insulated pipe and fittings
Standard ABS complete system;
Pipe, fittings, valves, transitions

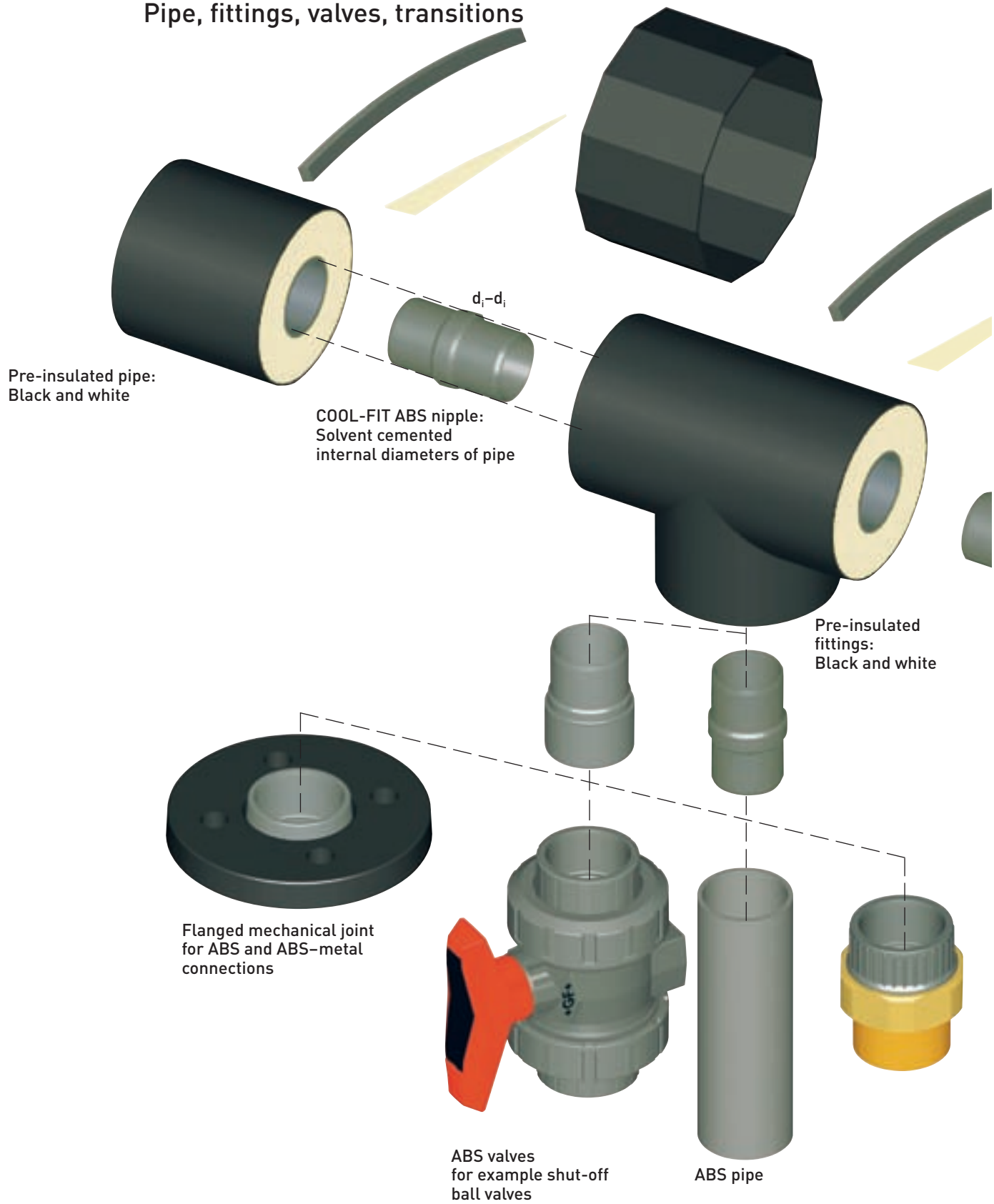

Shrink sleeve, short:
Vapour tight and
water tight

Gap insulator:
For visual check when
commissioning

Sealing tape:
For location of sleeve and
vapour seal, double-sided
sticky for easy location of
sleeve

$d_i - d_i$

$d_i - d$

COOL-FIT ABS
nipple: No removal
of PUR from pipe
necessary

Pre-insulated fittings;
For example, elbow 45°

Transition unions:
Copper-ABS with «O»-ring
for reliable sealing,
stainless steel and threaded
connections also available

System Advantages: Your Benefit

Speed

Fittings and Pipe are delivered direct to the site (ready to install).

Simple installation technique using speedy solvent cementing with no need to remove the PUR using internal diameter jointing fittings.

Time and cost saving handling due to the low weight of plastics.

Zero Corrosion

No maintenance, reduced down-time, constant long-term efficiency.

Reduce Costs for your Hanging System

Simplified pipe supports on outer jacket, no need for special refrigeration pipe hangers.

Pre-insulated pipe requires about 30% less hangers than standard plastic pipe.

Lower weight compared to metals means lower structural costs.

0.04 mm/m.K expansion coefficient, helps simplify pipeline design.

Top Efficiency

Save energy, thermal conductivity 0.026 W/m.K
PUR density > 45 kg/m³ with standard thickness of ± 35 mm for excellent insulating properties.

Smooth pipes: no encrustation, low pressure drops, no energy bridges due to support on outer jacket.

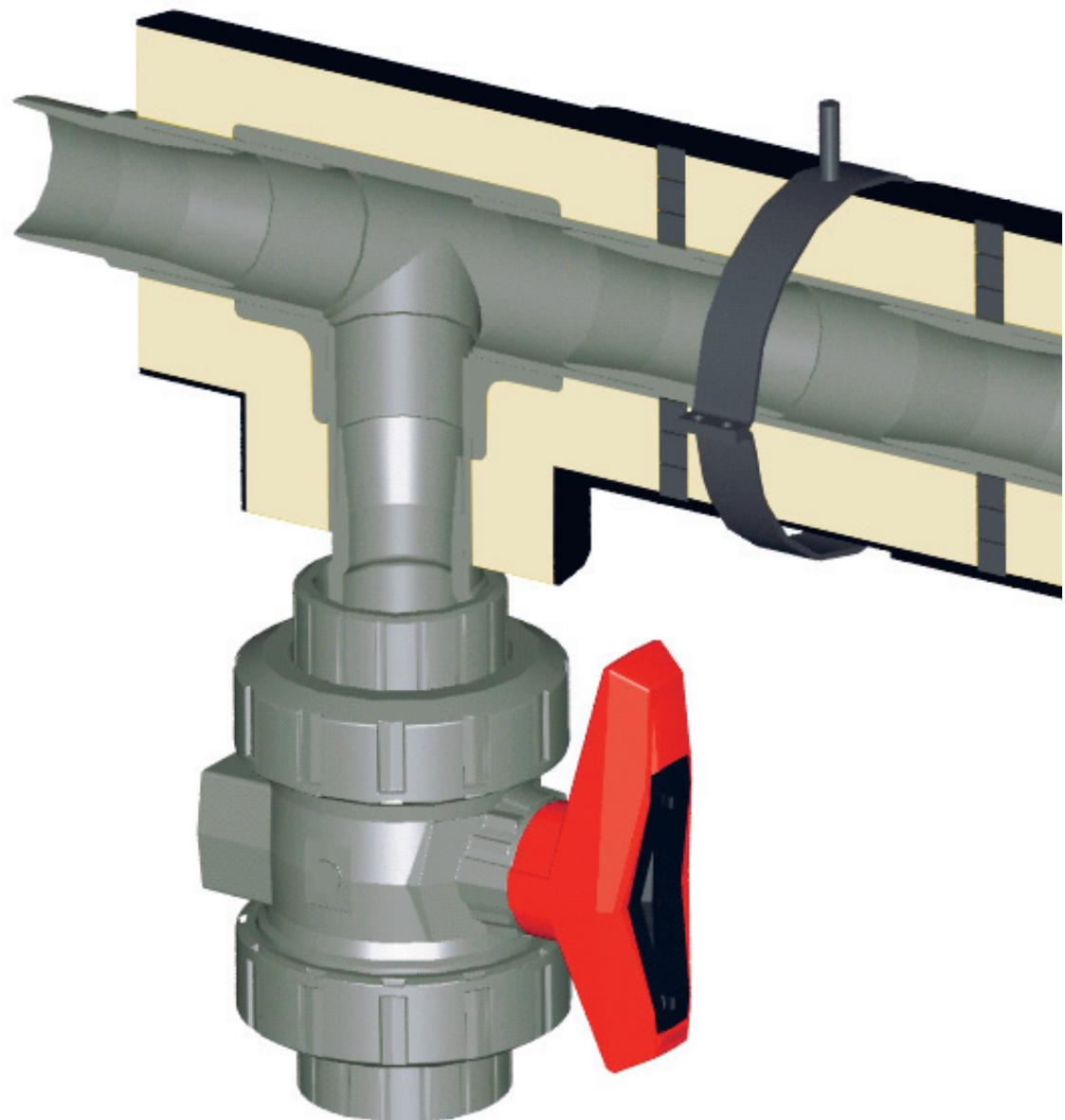

Reliability

Quality GF Piping Systems products: the number 1 Plastics Industrial Piping system manufacturer in the world.

Tried and Tested jointing technique with gap filling, cold welding TANGIT ABS cement.

Innovative: Clever

Developed for your needs.

Internal pipe connections means no need to remove the PUR insulation from the pipe or fitting.

Outdoor and Indoor Systems: Vapour Sealed

Black and white shrink sleeve for 100% vapour sealing 100% water tight system.

Hygienic Aesthetic

Top quality in performance and looks.

Smooth outer surfaces for hygienic environments.

No detrimental effects under high pressure cleaning.

Full Technical Design Support

www.cool-fit.georgfischer.com for on-line calculations of energy losses, temperature differences and more.

CAD libraries for accurate and quicker drawing. Specialist guidelines for design and installation and design of venting equipment, measuring equipment, transitions.

Full Technical Support during Installation

On-site advice and jointing technique training. Training Video for ABS jointing technique.

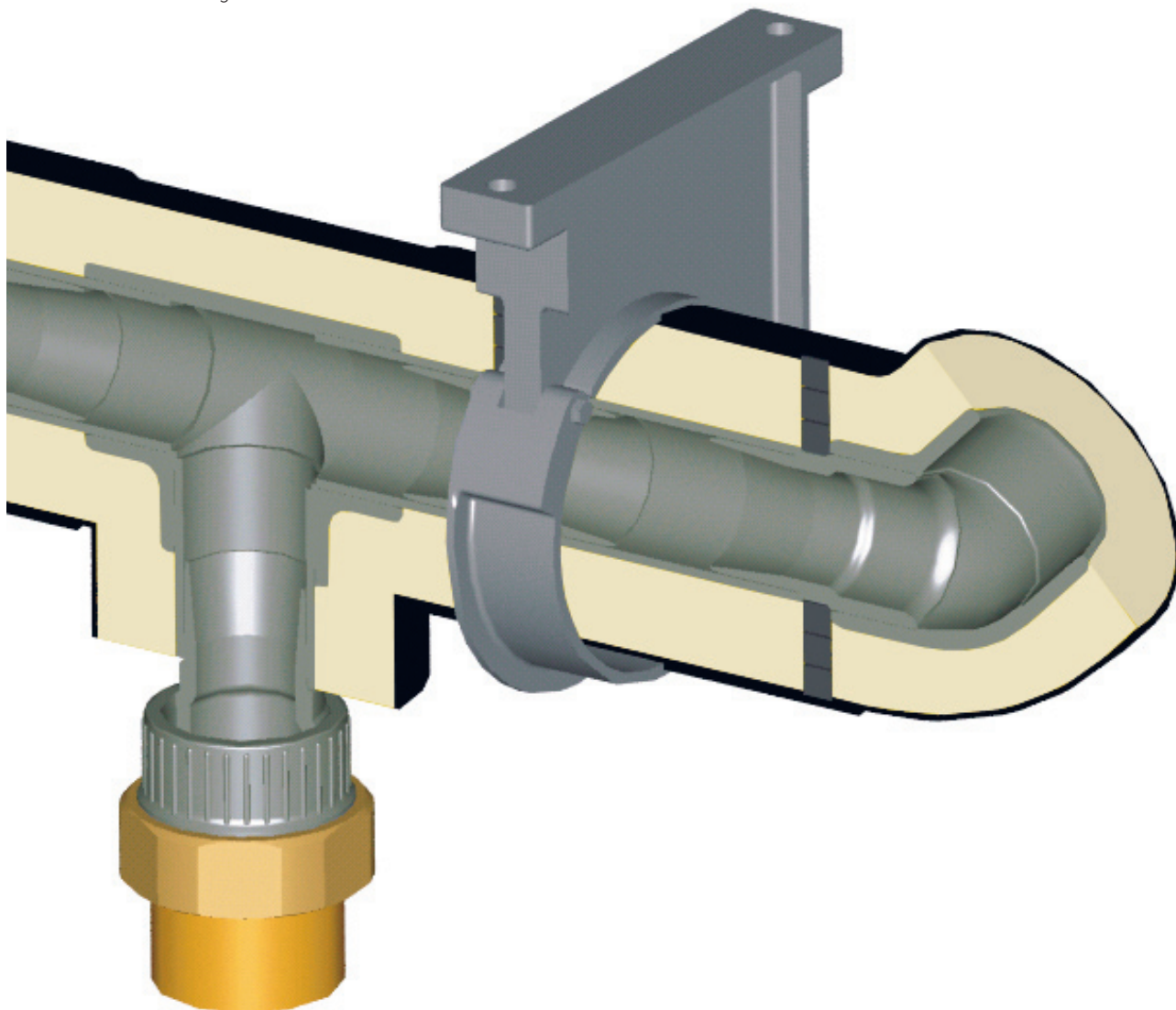

COOL-FIT ABS Pipe Technical Details

COOL-FIT ABS Contraction Coefficient: 0.04 mm/m.K

(One system coefficient for pre-insulated ABS pipe.
All three materials are bonded together deliberately to ensure expansion and contraction as one.)

COOL-FIT ABS is produced using high grade ABS pressure piping raw material, in use for over 20 years together with high grade low temperature PUR produced in high density form to offer optimal insulating qualities.

Pipe Specification

Product Identification;
Colour, PN 10, Production Date,
COOL-FIT, ABS.
White has no identification on pipe.

Carrier Pipe ABS

10 bar rated, cement jointed
ABS plastic pipe.
5 meter lengths.
ABS Pipe to ISO 15493.

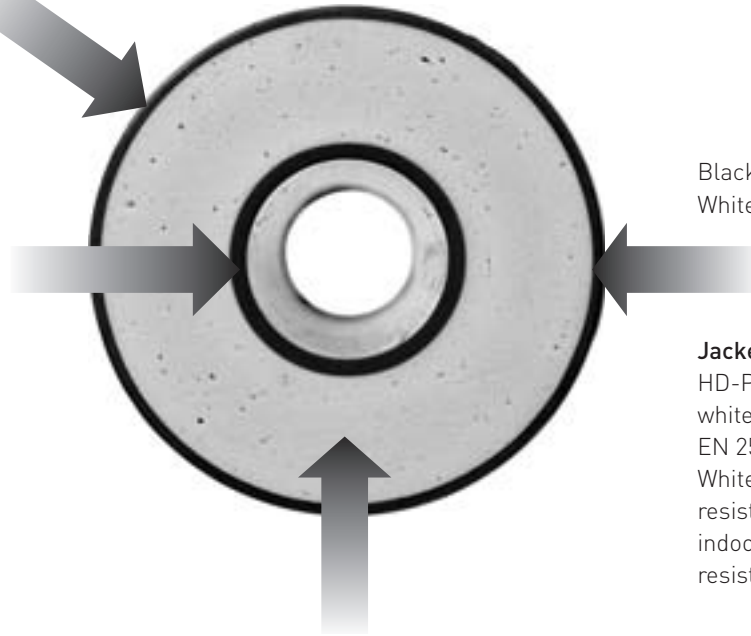

Black RAL 9004
White RAL 9010

Jacket Pipe

HD-PE to DIN 8075 in black or white. Functional requirements to EN 253.
White PE is only moderately UV resistant and is recommended for indoor applications. Black is UV resistant.

Hard Polyurethane Foam (PUR)

Thermal Conductivity at 50 °C < 0.026 W/m.K
Axial Shear Strength ≥ 0.12 N/mm²
Tensile Strength ≥ 0.2 N/mm²
Compressive Strength ≥ 0.3 N/mm²

Foamed using polyol and isocyanate
Expansion Coefficient 0.04 mm/m.K
Core density > 45 kg/m³
Average Cell Sizes max. 0.5 mm

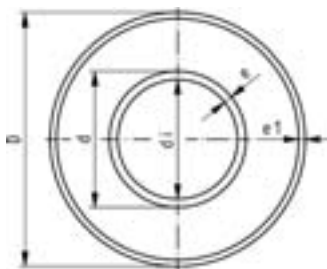

Code Number		Carrier Pipe ABS		Jacket Pipe HDPE	Weight (PE + ABS + PUR)	Volume	Pipe Support Distance *	Heat Transfer Coefficient
Black	White	d x e	d _i	D x e1	kg/m	U/m	m	W/mK
169 017 682	169 017 782	25 x 2.3	20.4	90 x 2.2	1.24	0.36	1.55	0.13
169 017 683	169 017 783	32 x 1.9	28.2	90 x 2.2	1.29	0.61	1.55	0.162
169 017 684	169 017 784	40 x 2.4	35.2	110 x 2.7	1.76	0.95	1.65	0.165
169 017 685	169 017 785	50 x 3.0	44	110 x 2.7	1.89	1.49	1.65	0.213
169 017 686	169 017 786	63 x 3.8	55.4	125 x 3.0	2.48	2.34	1.75	0.245
169 017 687	169 017 787	75 x 4.6	65.8	140 x 3.0	3.17	3.36	1.90	0.27
169 017 688	169 017 788	90 x 5.4	79.2	160 x 3.0	4.11	4.80	2.05	0.293
169 017 689	169 017 789	110 x 6.6	96.8	180 x 3.0	5.22	7.21	2.20	0.341
169 017 691	169 017 791	140 x 9.2	121.6	225 x 3.2	8.16	11.69	2.55	0.356
169 017 692	169 017 792	160 x 10.5	139	250 x 3.9	10.34	15.22	2.75	0.381
169 017 693	169 017 793	200 x 13.1	173.8	280 x 4.4	13.42	24.50	3.05	0.513
169 017 694	169 017 794	225 x 14.8	195.4	315 x 4.9	17.97	30.05	3.30	0.515

COOL-FIT ABS pipe d250, d280 and d315 available on request

* COOL-FIT ABS support distance are the same from -50 °C to +40 °C

d: nominal outside diameter of ABS pipe
d_i: nominal internal diameter of ABS pipe
D: nominal outside diameter of PE pipe
e and e1: nominal wall thicknesses

COOL-FIT ABS Fittings Technical Details

COOL-FIT ABS Fittings are manufactured using the same raw materials as the pipe and are thus completely compatible with the COOL-FIT ABS pipe in terms of insulating properties and also joining technique.

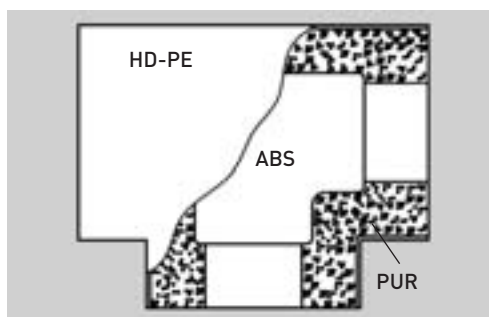

COOL-FIT ABS Fitting

There are 2 types of COOL-FIT ABS Fittings, namely the d_i type and the d type. To cement d_i fittings to COOL-FIT ABS pipe requires a d_i - d_i fitting.

d_i is the designation for a joint which takes place in the internal diameter of the pipe. d_i 25 for instance refers to the internal diameter of d25 pipe.

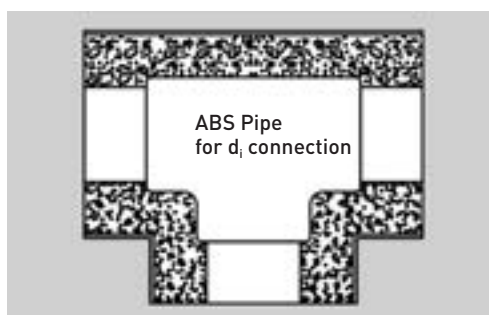

d_i type fitting

d is the designation for a normal socket solvent cemented joint as per the standard GF Piping Systems ABS range.

The jointing material and technique for d_i and d are the same, with the same cement and the same tooling. Refer to pages 36–39 for details.

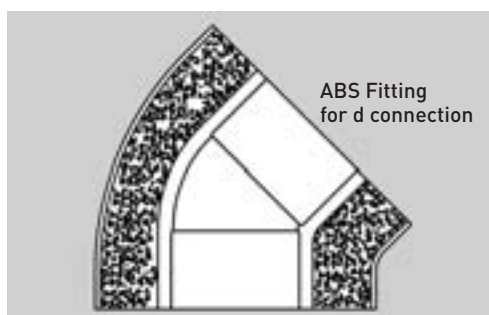

d type fitting

COOL-FIT ABS pipe to pipe connections are achieved using the d_i - d_i COOL-FIT ABS nipple, see diagram.

Note: dimensions above d90 must be calibrated using the COOL-FIT ABS Tool, see next page for details.

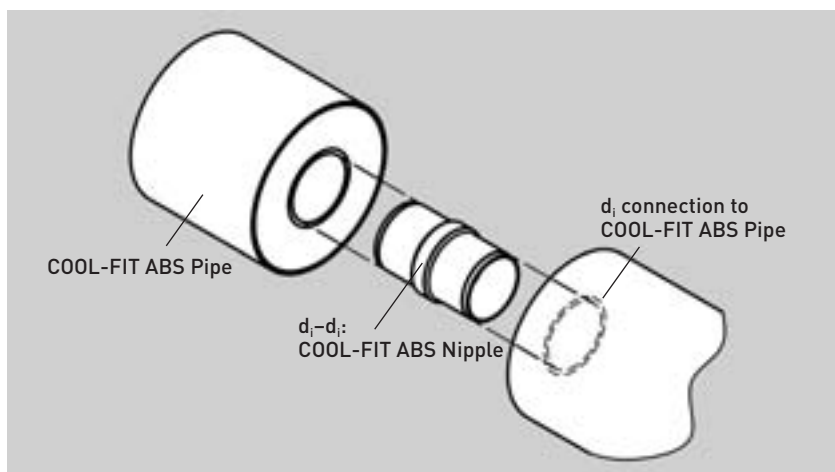

Accessory Equipment

COOL-FIT ABS Nipple (ABS)

The nipple exists in three versions:

d_i-d_i _____
for pipe to pipe and pipe to d_i-d_i
type fitting connections using the internal
diameter of the pipes

$d-d_i$ _____
for pipe to $d-d_i$ type fitting connections

d_i-d red _____
to reduce diameter of the carrier pipe
[Note: for dimensions $d90$ and above the COOL-FIT ABS Cali-
bration Tool is required before jointing the internal diameters
of the pipe].

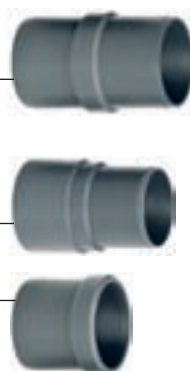

COOL-FIT ABS Calibration Tool

It is necessary to calibrate pipe in dimension $d90$ and above
to allow jointing using the COOL-FIT ABS nipple.

This tool calibrates the inside diameter of the pipe to an
exact dimension to allow internal jointing.

See page 34 for order numbers and pages 42–43 for hand-
ling instructions.



COOL-FIT ABS Shrink Sleeve, Short

Used to vapour seal the outer jacket in PE. The sleeve is
85 mm wide and can only seal equal dimensioned PE jackets.
To ensure a vapour and water tight joint with the same insu-
lating properties as the pipe the mini-sleeve should be used
with the gap-insulator and the sealing tape.

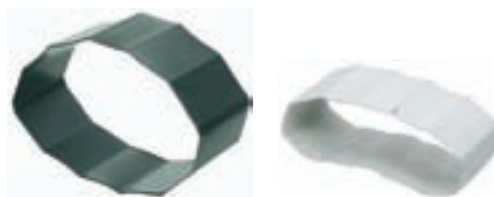

COOL-FIT ABS Sealing Tape

A roll of 35 mm wide, double sided mastic tape to vapour seal
the joint. Double-sided sticky tape helps locate the shrink
sleeve over the gap before shrinking and ensures a top
quality seal.



COOL-FIT ABS Gap Insulator

Width 13 mm and a lambda / heat conductivity of 0.04 W/m.K,
use of this insulation ensures the same insulating properties
in the gap as the pipe.

Use of other insulating and sealing methods such as tape is
possible. Please consult the manufacturers of these mate-
rials for application instructions, insulating properties and
life-span.



Accessory Equipment for Solvent Cement Jointing, Reducing Diameters and End Caps

Tangit ABS and Cementing Equipment

The solvent cementing equipment is exactly the same for internal di jointing as for standard d jointing using Tangit ABS. Code numbers can be found on page 36 in this document, see pages 36–43 for jointing instructions.



COOL-FIT ABS Shrink Sleeve, Long

This sleeve is 285 mm long, only to be used when sealing PE to PE outer jackets, not for use on ABS. For exact reducing possibilities see below.



Shrink Sleeve, Long Reducing Diameters

The COOL-FIT ABS «shrink sleeve, short» can only seal equal dimensions of PE outer jacket. The table below shows which dimensions can be sealed using which long shrink sleeve.

NOTE: the sealing tape should be applied to both outer diameters of the PE pipes.

PE Dims (D)	90	110	125	140	160	180	225	250	280	315
Shrink Sleeve, Long	738.011.167 (black) and 738.011.267 (white)		738.011.170 (black) and 738.011.270 (white)			738.011.173* (black) and 738.011.273 (white)				

* only for use over maximum three dimensions, for example, d315 to d225 or d280 to d180

End-Caps

End-caps are to be used for sealing the PUR against any water ingress at the transition to ABS standard.



Sealing the PUR should be achieved using a chemically compatible glue to ABS.

GF Piping Systems offers silicon glue. If silicon products are prohibited then non-solvent based glues can be used. Chemical compatibility can also be checked by GF Piping Systems.

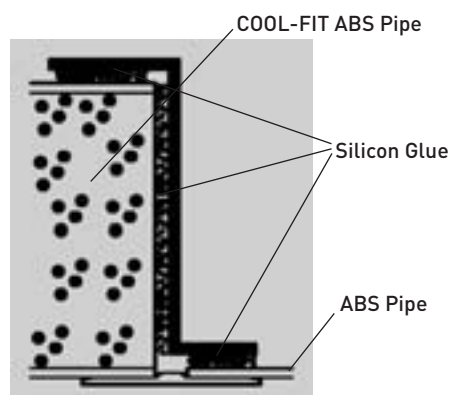

Shrink cap

The shrink cap is only to be used to seal PE to PE, not to be used on ABS pipe. The flame used to shrink the sleeve may damage the ABS pipe. Ideal for use with T-90° reducers. For dimensions please refer to the product range in this brochure. No sealing separate sealing tape is required, the sealant is integrated into the cap. If the length of the cap is longer than the surface to be sealed then the cap can be cut back but without removing any sealant.



COOL-FIT ABS Reducing Diameters

Reducing Pipe Dimensions for COOL-FIT ABS

To reduce the ABS carrier pipe diameter see sketches below. The example below shows how the carrier pipe dimension is reduced from COOL-FIT ABS 90/160 to 50/110.

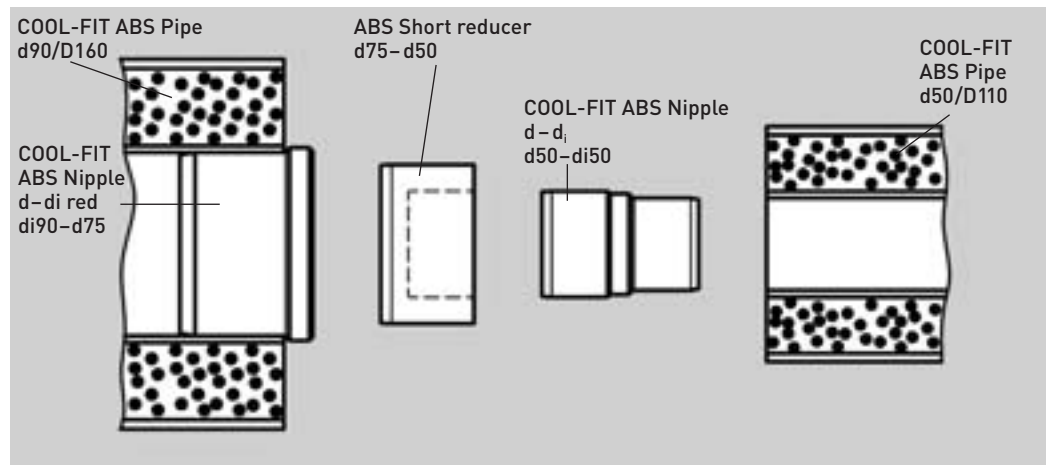

Reducing from a «d-Type» COOL-FIT ABS Fitting to COOL-FIT ABS Pipe

The d type fittings have a standard ABS d joint as the fitting connection and therefore the standard ABS short reducers can be used to reduce the diameter and then the d-d_i COOL-FIT ABS nipple for the connection to the COOL-FIT ABS pipe.

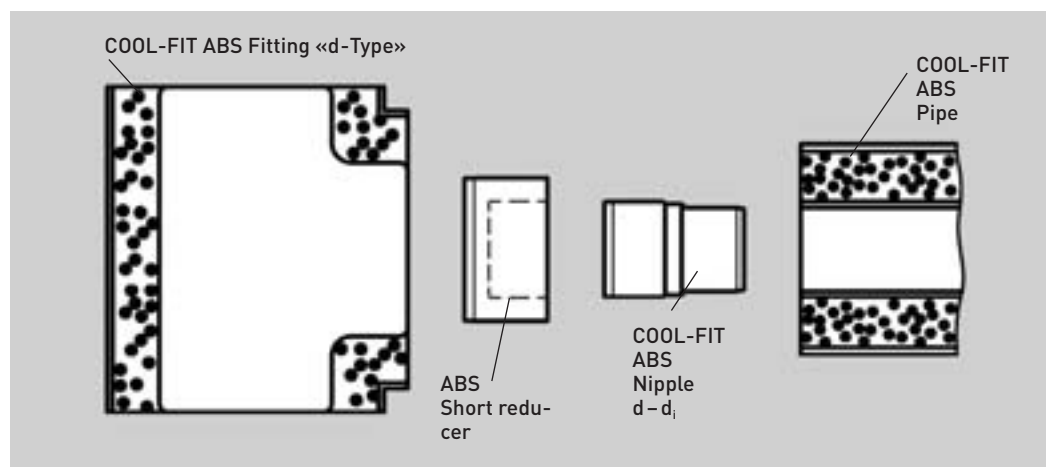

COOL-FIT ABS Pressure-Temperature Parameters

Pressure ratings for thermoplastic pipe are always quoted for water at 20 °C. It can be used at higher temperatures but it is a fundamental principle in thermoplastic pipework that if the working temperature is increased then the working pressure must be reduced.

The table below shows, for COOL-FIT ABS, the maximum permissible pressures at various temperatures up to the maximum allowable working temperature of + 40 °C. The table is based on an ambient temperature of 20 °C with water as the medium. A safety factor of 1.8 is incorporated into all calculations with a minimum life span of 25 years.

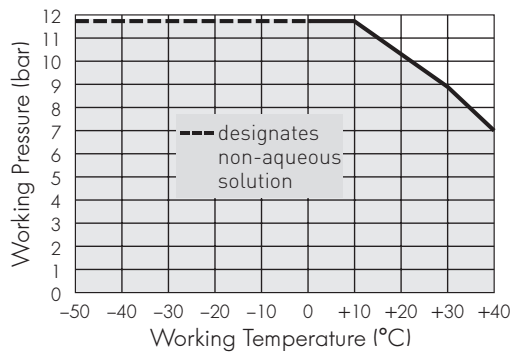

For working temperatures below 0 °C an anti-freeze has to be used in the water to prevent freezing. The above pressure-temperature curve applies only when the medium is water, therefore for non pure water mediums a de-rating factor has to be applied to the above curve. This is standard procedure for all plastic piping systems.

For **example** if the medium is a water-diluted **glycol** solutions ≤ 50% (max. concentration allowable for ABS) then a de-rating factor of 0.5 applies to the standard pressure-temperature curve. So at -10 °C for a minimum life-span of 25 years the maximum allowable working pressure is 0.5 x 11.8 = 5.9 bar. For more details regarding these de-rating values for chemical solutions or trade named products please consult GF Piping Systems.

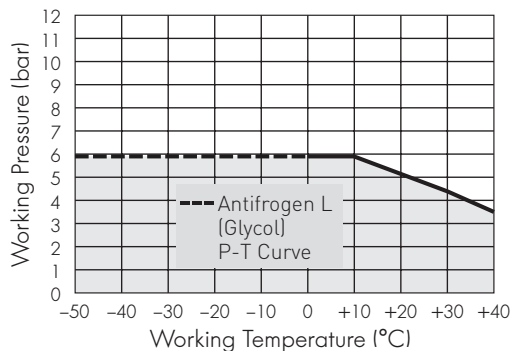

General

ABS is generally resistant to most diluted inorganic acids, bases and salts and to most animal oils and fats. It is not resistant to organic solvents, pure alcohols, petrol, acetic acid and vegetable oils.

Ice Slurry

Ice slurry is a mixture of ice particles (0.01–0.03 mm width), water and an anti-freeze agent, usually an alcohol, salt or glycol. GF Piping Systems has undertaken extensive testing of ice slurry with ABS and can give recommendations regarding for example pipeline layout, flow rates and pressure drops. Please ask your local GF Piping Systems representative for details.



Ice Slurry

Chemical Resistance

Please consult GF Piping Systems for detailed information regarding chemical resistance.

GF Piping Systems offers written confirmation on material compatibility for all chemical applications.

Temperature °C	PN 10 bar (145 psi)
-50	11.8
-20	11.8
0	11.8
20	10.5
30	8.9
40	7

Glycol Solutions

ABS can be used with glycol solutions (eg. Antifrogen L, Dowfrost) however a de-rating factor applies to the standard water based temperature – pressure curve, see example.

Organic Salt Solutions

These mediums are usually potassium formate or acetate water based solutions, with low viscosities at low temperatures. Tradename examples: HYCOOL, TEMPER, TYFOXIT, ANTIFROGEN KF. ABS can be used with these types of mediums however, a de-rating factor applies to the standard water based pressure-temperature curve. Please consult GF Piping Systems for details. It is important that the complete pipe, irrespective of pipe system material is properly devented both during filling and commissioning.

It is very important to follow the manufacturers instructions for pipeline design and handling of these mediums.

Technical Data

General Comments to Plastics Orientated Pipeline Design and Installation

The design and installation of thermoplastic pipe systems requires designers and installers alike to take into account the fact that plastics have different physical characteristics to metal. Although GF Piping Systems ABS and COOL-FIT ABS are both very robust systems, nevertheless, care should be taken during handling and transport to avoid damage. Also thermoplastics have certain physical characteristics, such as a high expansion coefficient, which need to be taken into account in the design phase.

GF Piping Systems has been successfully developing and selling plastic pipe systems into a spectrum of high performance installations, such as highly concentrated chemicals, for over 40 years, and experience has shown that when engineers and installers take into account the advice given in our technical literature plastics are an economical and reliable alternative to metals.

As a general rule for designing and installing plastics one of the major differences is that plastics can and should be allowed to move after commissioning i.e. move under the influence of temperature fluctuation and pressure changes. For instance using pipe brackets that allow horizontal movement and not clamping the system in place is a must for plastic piping installations.

The following technical information covers the fundamental information required to ensure an economical and trouble free installation: Not all details however are published in this document, for more detailed information or if you have a specific question please ask your local GF Piping Systems company, consult www.cool-fit.georgfischer.com or e-mail us at info@cool-fit.georgfischer.com for advice if you have any questions.

COOL-FIT ABS and ABS On-Line Calculation Tool

GF Piping Systems has developed a calculation tool to calculate accurately and quickly all the necessary parameters for the engineering of secondary refrigeration or cooling systems using COOL-FIT ABS or standard ABS pipe.

On-Line via www.cool-fit.georgfischer.com

+GF+ **GEORG FISCHER**
PIPING SYSTEMS

Pressure drops | Condensation | Heat loss | Pipe dimensioning | Pipe supports | Expansion/Contraction | Temperature | Data

Along pipe | Over fittings | Over valves

Pressure drops - Along pipe

System parameters

Temperature		Specification	
Flow temperature	<input type="text" value="0"/> °C	Pipe system	<input type="text" value="ABS PN10"/>
Ambient temperature	<input type="text" value="23"/> °C	Fluid type	<input type="text" value="Water"/>
Wind velocity	<input type="text" value="0.5"/> m/s	Concentration	<input type="text" value="-"/>

Options

- Calculate
- Print
- Clear

Pipe Pressure Drop (ABS and COOL-FIT ABS)

When calculating the hydraulic pressure loss in m/m in a plastic pipe the excellent smoothness of ABS means that when using the standard Moody Diagram the smooth pipes curve can be used to derive the friction factor.

Imperically it is possible to use the following formulas and procedure to calculate pressure loss in the pipe for any type of fluid.

Pressure Loss in Pipes

The hydraulic loss, in m/m, is given by:

$$\Delta p_{pi} = \frac{2fv^2}{gd_i}$$

where Δp_{pi} = hydraulic loss (m/m)
f = friction factor
(dimensionless)
 d_i = pipe inside diameter (m)
g = acceleration due to gravity = 9.81 m/s²
v = flow velocity (m/s)

In order to determine the value of the friction factor (f) the Reynolds number must be used. The Reynolds number is dimensionless and may be considered as the ratio of the dynamic forces of mass flow to the shear resistance due to fluid viscosity. It may be calculated using the following formula:

$$Re = \frac{vd_i}{\nu}$$

The Reynolds number may then be related to the friction factor through an empirical formula such as Blasius' smooth pipe formula:

$$f = \frac{0.079}{Re^{0.25}}$$

valid for Re between 3000 and 10⁵.

For thermoplastic pipes the relative roughness is negligible and if the user is using Moody curves the curve labelled «smooth pipes» gives the correct relation. The roughness factor for ABS pipes is K=0.007 mm. Using the derived f value the hydraulic loss, Δp_{pi} can be calculated. Unlike metal pipes no allowance need be made for corrosion and subsequent reduction of pipe bore or roughness.

For ease of calculation nomograms are available in standard GF Piping Systems literature.

Pressure Drop in Fittings (ABS and COOL-FIT ABS)

The pressure losses depend upon the type of fitting as well as on the flow in the fitting. The so-called ζ -value is used for calculations.

Page 18 contains the ζ -values for common fittings.

To calculate the total pressure loss in all fittings in a pipeline take the sum of the individual losses, i.e. the sum of all the ζ -values.

The pressure loss can be calculated according to the following formula:

$$\Delta p_{fi} = \frac{\sum \zeta \cdot v^2 \cdot \rho \cdot 1000}{2g}$$

where Δp_{fi} = pressure loss in all fittings (mm)
 $\sum \zeta$ = sum of the individual losses
v = flow velocity (m/s)
g = acceleration due to gravity = 9.81 m/s²
 ρ = density of the transported medium
(g/cm³ or t/m³)

Pressure Drop in Fittings

Please note there is a slight difference in the coefficient of resistance factors for standard ABS fittings or for COOL-FIT ABS pre-insulated fittings. This is due to the extra fitting required, namely the internal special nipple and also as some COOL-FIT ABS fittings have a piece of pipe in the fitting, namely the di fittings.

Coefficient of Resistance for ABS Fittings

Pipe outside diameter (d)	20	32	50	≥ 63
Type of fitting	Coefficient of Resistance ζ			
90° Bend	1.5	1.0	0.6	0.5
90° Elbow	2.0	1.7	1.1	0.8
45° Elbow	0.3			
Tee 90°	1.5			
Inlet	0.5			
Outlet	1.0			

Coefficient of Resistance for COOL-FIT ABS Fittings

The factors given below are for the COOL-FIT ABS fittings inclusive COOL-FIT ABS nipple.

Pipe outside diameter (d)	20	32	50	≥ 63
Type of fitting	Coefficient of Resistance ζ			
90° Bend	1.65	1.15	0.75	0.65
45° Elbow	0.45			
Tee 90°	1.8			
Pipe to Pipe (d _i -d _i)	0.1		0.25	
Tee 45°	0.8		1.0	

Pressure Drop in Valves (ABS)

Flow Rate / Flow Factor

The k_v factor is defined as the flow rate of water in litres per minute with a pressure drop of 1 kg/cm² across the valve.

The relationships between k_v factor, flow rate (Q) and pressure drop (Δp) are given in the following formula:

Liquids with kinematic viscosity less than 22 centistokes
e.g. water, hydraulic oil

$$k_v = Q \sqrt{\frac{\rho}{\Delta p}} \quad \text{or} \quad Q = k_v \sqrt{\frac{\Delta p}{\rho}}$$

$$\text{or } \Delta p = \frac{\rho \cdot Q^2}{k_v^2}$$

where Q = flow rate (litres per minute)
ρ = density of the liquid (kg/dm³)
Δp = pressure drop (kg/cm²)

Liquids with kinematic viscosity greater than 22 centistokes

The effect of viscosity, caused by friction between the particles of the fluid, is no longer negligible, and the flow rate is reduced. The flow factor must be multiplied by a correction factor, c, to give a new flow factor, k_{vn}.

$$k_{vn} = k_v \cdot c$$

The correction factor is given by:

$$c = 1 + \frac{\nu \sqrt{k_v}}{200 \cdot Q} \quad \text{valid for } c \leq 3 \text{ only}$$

where ν = kinematic viscosity (centistokes)
k_v = flow factor for water (dimensionless)
Q = flow rate (litres per minute)

Pipe Support Distances Horizontals

For ABS at temperatures > +20 °C refer to ABS specific literature

	Standard ABS at 20 °C water, metres	COOL-FIT ABS water, metres
d16	0.7	-
d20	0.8	-
d25	0.85	1.55
d32	1.0	1.55
d40	1.1	1.65
d50	1.15	1.65
d63	1.3	1.75
d75	1.5	1.90
d90	1.6	2.05
d110	1.8	2.20
d140	2.05	2.55
d160	2.2	2.75
d200	2.3	3.05
d225	2.4	3.30

The above values are for pipe supported using normal 360° pipe clamps. For values using complete axial support please consult the COOL-FIT ABS on-line calculation tool at www.cool-fit.georgfischer.com

Pipe supports for ABS should allow the system to move under the influence of temperature, see «Pipe Supports» page 21 for details.

Heat Transfer Coefficients – Pipe ABS and COOL-FIT ABS

	ABS W/m.K	COOL-FIT ABS W/m.K
d16	1.278	-
d20	1.487	-
d25	1.742	0.13
d32	2.078	0.162
d40	2.413	0.165
d50	2.81	0.213
d63	3.253	0.245
d75	3.643	0.27
d90	4.073	0.293
d110	4.637	0.341
d140	5.319	0.356
d160	5.686	0.381
d200	6.385	0.513
d225	6.73	0.515

Pipeline Design and Layout

Following are the formulas and information required to calculate change in length of the pipe and allowable flexible length.

$$\Delta L = L \cdot \Delta T \cdot \delta$$

ΔL = change in length of pipe
 L = original length of pipe during installation
 δ = coefficient of expansion (ABS 0.1, COOL-FIT ABS 0.04 mm/m)
 ΔT = difference in temperatures between ambient temperature during installation and normal working temperature.

Expansion and contraction in a pipe line can only take place in a straight direction; It is therefore necessary to calculate the change in length and then design in compensation for this to avoid unnecessary stresses.

Example: Calculating ΔL for the sketch beside for the following assumed conditions would be done as follows.
 L = 15 metres (total straight length of pipe)
 Ambient temperature during installation = +25 °C
 Working temperature of medium = -5 °C
 T = -30 (working temperature – installation temperature)
 δ = 0.1 mm/m.K (for ABS)
 $\Delta L = 15 \times -30 \times 0.1$
 $\Delta L = -45$ mm (minus designates a contraction of the length of pipe)

A simple and effective way to compensate for this change in length is to pre-stress the system and if necessary to place a fixed point in the middle of the line to reduce the amount of lateral expansion.

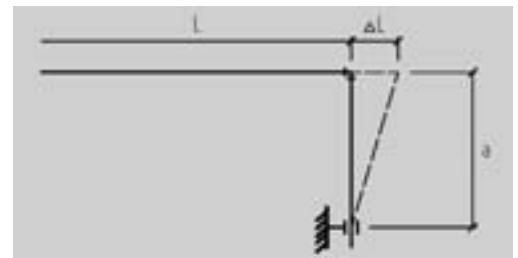

Design of other types of flexible sections and use of compensators is covered in the standard Georg Fischer technical literature for plastic pipe systems.

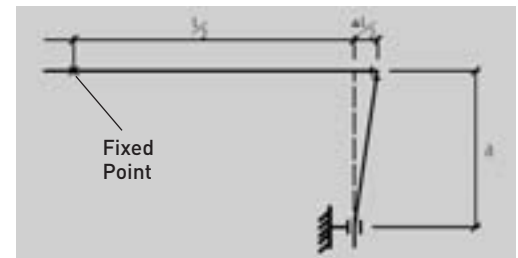

Pipe Supports for ABS

Plastic pipe systems should be installed using supports designed for use with plastics and should then be installed taking care not to damage or over stress the pipe.

KLIP-IT, Types 060 & 061

GF Piping Systems has its own specially designed pipe support clips in PP and PE for use with plastic pipes. See product range documentation.



What is a loose pipe bracket?

A **loose pipe bracket** is a bracket which allows axial movement of the pipe, to allow stress free compensation of temperature changes and compensation of any other operating condition changes.

The inner diameter of the bracket should be larger than the outside diameter of the pipe to allow free movement of the pipe. The inner edges of the brackets should be free from any sharp contours which could damage the plastic. If the brackets' inside diameter is not larger than the pipe then the bracket should not be fully tightened, thus allowing the pipe to move.

Another method is to use brackets with spacers which also avoids clamping the bracket on the pipe.

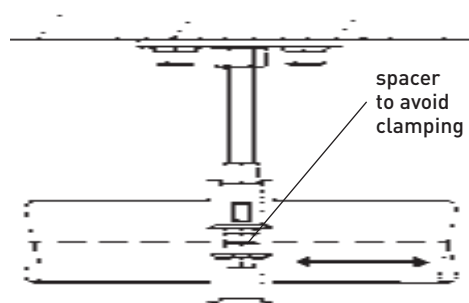

What is a fixed point?

A fixed pipe bracket is a bracket which prevents the pipe from moving horizontally. The aim of which is to control system stresses caused by temperature changes.

This **should not** be done by simply clamping the bracket onto the outside of the pipe! This can cause deformation and physical damage to the pipe, damage that sometimes only later becomes visible.

It should be done either by using two sockets as per sketch below or by using a «double headed» bracket, see also sketch below.

See GF Piping Systems plastic technical handbook and homepage for details regarding pipeline layout and installation.

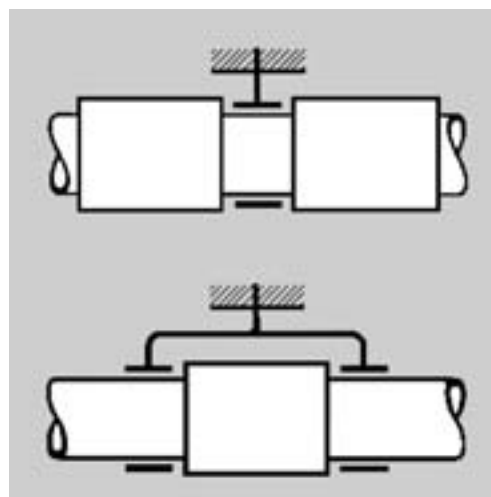

Allowable flexible length, H, for ABS

To allow the pipe to bend without stressing it unduly there is a minimum length required between direction change and pipe support. This takes into account the flexibility of the pipe.

This length is called H is calculated using the formula:

$$H = c \cdot \sqrt{d \cdot \Delta L}$$

where c is the material constant which is derived from the creep modulus of the material which is: ABS 32.7

The following table allow the flexible length a to be read from the graph once delta L has been calculated.

Below are the H values for ABS.

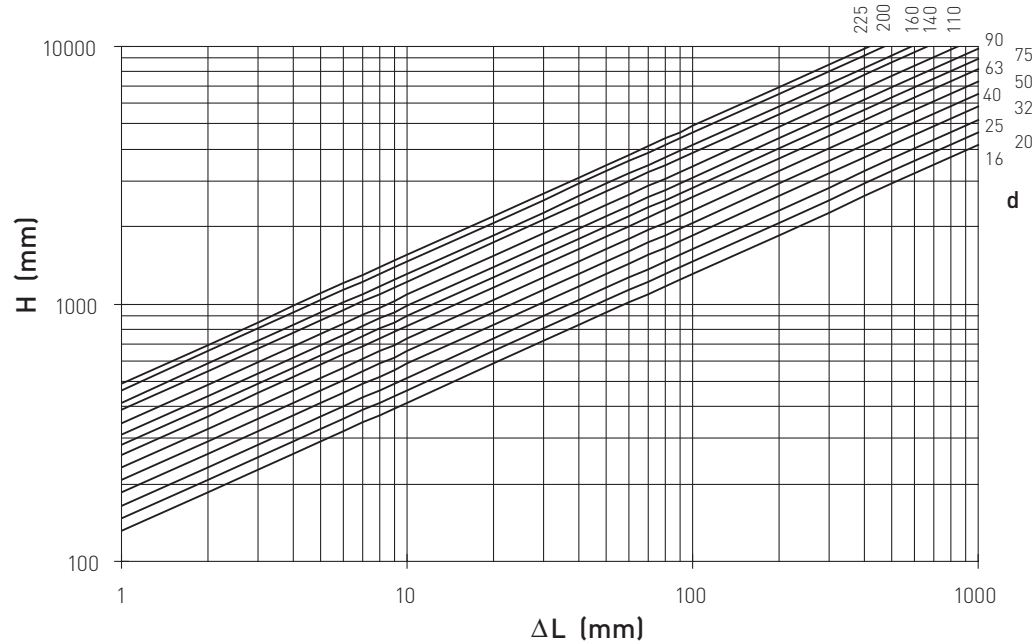

- H Allowable flexible length (Expansion loop), mm
- d Pipe (ABS) outside diameter, mm
- ΔL Change in length, mm

Allowable flexible length, H, for COOL-FIT ABS

The H value for a given ΔL and dimension can be read from the tabel below, H values are in mm.

COOL-FIT ABS d/D	ΔL								
	10	20	30	40	50	100	150	200	300
25/90	780	1103	1351	1560	1744	2467	3021	3488	4272
32/90	780	1103	1351	1560	1744	2467	3021	3488	4272
40/110	862	1220	1494	1725	1928	2727	3340	3856	4723
50/110	862	1220	1494	1725	1928	2727	3340	3856	4723
63/125	919	1300	1592	1838	2055	2907	3560	4111	5035
75/140	973	1376	1685	1946	2175	3076	3768	4351	5328
90/160	1040	1471	1801	2080	2326	3289	4028	4651	5696
110/180	1103	1560	1911	2206	2467	3488	4272	4933	6042
140/225	1233	1744	2136	2467	2758	3900	4777	5515	6755
160/250	1308	1850	2266	2616	2925	4136	5066	5850	7164
200/280	1462	2068	2533	2925	3270	4624	5664	6540	8010
225/315	1551	2194	2687	3102	3468	4905	6007	6937	8496

Plastic to Metal Connections

Fundamentally three options are available for plastic to metal connections, namely; threads, flanged connection and unions. GF Piping Systems recommends that wherever possible mechanical connections are used (unions and flanges) together with a located gasket such as O-Ring.

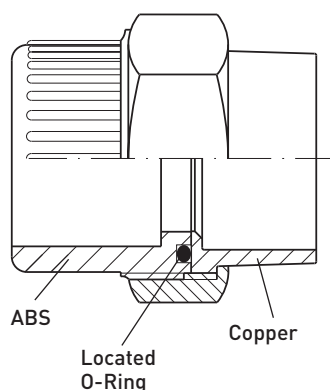

Union Connections

This is the most reliable and cost effective method to connect metal to plastic. GF Piping Systems has a whole range of transition unions with O-Rings specially designed to compensate for the changes in length which can occur in ABS and COOL-FIT ABS due to temperature fluctuations. See ABS product range for details of the copper, brass, stainless steel and malleable iron transition unions available.

Flange connections

Metal to ABS and also ABS to ABS connections using flange adaptors is possible up to DN300. For bolt torques, tightening sequences etc please refer to standard the GF Piping Systems Plastics Technical Handbook. GF Piping Systems's new revolutionary PN 16 PP V-Flange is light weight, with location stubs to aid installation and is designed to avoid high stresses during tightening. GF Piping Systems recommends this type of flange for use with plastic flange connections. All mechanical connections including flanges should be re-tightened after commissioning if the working temperature is lower than the temperature during installation.

Threaded Connections

GF Piping Systems recommends avoiding threaded connections for plastic wherever possible, solvent cementing is a very reliable and speedy method of jointing and should be preferred to threaded connections. For sealing threaded joints the mating parts should always be parallel to tapered. In the ABS range only the plastic female thread with reinforced ring should be used for connection to metal threads. For sealing we recommend **only** PTFE tape. 2 layers of tape applied in a clockwise direction, the components should then be joined carefully to avoid damage to the plastic thread. Mechanical wrenches should not be used to tighten the joint. Namely strap type wrenches prevent damage to the plastic components.

Installation of Measuring Equipment or other Accessories

Following is a summary of the most important details regarding this subject, for more detailed guidelines please consult www.cool-fit.georgefischer.com.

Measuring Equipment in an ABS System

ABS saddles are available for mid to large dimensions to be cemented to the pipe using a wedge to fix the parts to allow curing of the cement. Please consult GF Piping Systems or www.cool-fit.georgefischer.com for the availability and fitting instructions for these fittings.

Tee 90° reduced

Standard ABS tees can be fitted with a short reducer and then a threaded nipple or a piece of pipe with a transition union to install equipment, this should be planned in in the design stage of the plant. We recommend use of a transition union rather than a threaded connection.

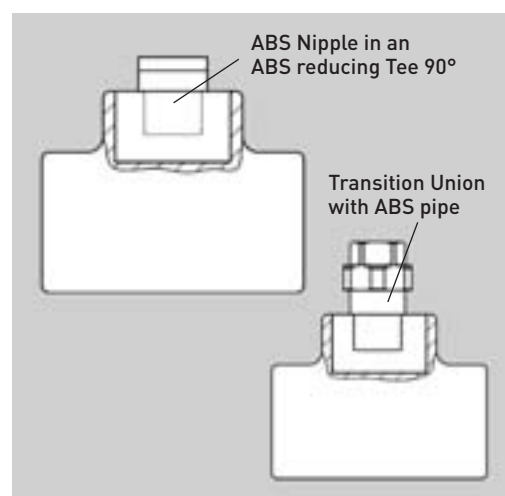

Retro-Installation of Equipment: into an already existing system

For dimensions > d90 it is possible to use the extra wall thickness in a cemented joint to bore through pipe and fitting and install a transition union. See www.cool-fit.georgefischer.com for installation details.

Measuring Equipment in COOL-FIT ABS

As with the ABS system Tee 90° reducers are available in COOL-FIT ABS. These then need to be planned into the system during the design phase of the plant.

At present it is not possible to install equipment into an already existing COOL-FIT ABS pipe, other than cutting the pipe and placing a Tee in the pipe.

De-Venting or De-aeration

It is always important to remove air from any piping system, for salt solutions this is particularly important due to their corrosive nature.

Summary of De-aeration process,

- always fill the system slowly from the bottom up
- induce a vacuum in the system before filling
- install manual and/or automatic de-aerators at the highest points in the system
- long horizontal runs should be installed at a slight gradient
- avoid low points i.e. U-configurations where air can be trapped
- install de-aerators with a buffer zone of fluid below them, see sketch below
- always observe the medium manufacturers specific recommendation for filling, mixing etc as secondary fluids differ in their composition

For further information see

www.cool-fit.georgfischer.com

SIGNET Flow Measuring Equipment

GF Piping Systems Signet offer paddle wheel flow measuring equipment which can be used to very cost effectively measure the flow of your medium, with digital and analogue display devices including cabinet housings for installation in display units.

These SIGNET flow sensors can be installed using specially designed installation fittings, ask GF Piping Systems for installation fittings details.

COOL-FIT ABS:

Please remember to place the shrink sleeve over the pipe before jointing and leak test the system before sealing the gap between fittings and pipe.

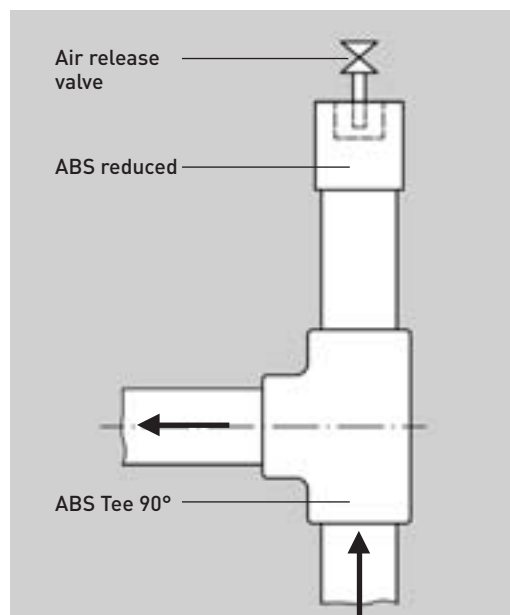

Pressure Testing

Medium: We recommend the use of water as testing medium. The solvent gases which may be left in the pipe after jointing dissolve in water and thus water also removes all excess solvents from the system. Water also has a very low compression ratio and is thus safer as a testing medium.

If water is not practical then inert gases can be used with ABS and COOL-FIT ABS. However the maximum test pressure should not exceed 1.5 bar.

Compressed air should not be used with ABS or COOL-FIT ABS.

Pressures:

For water 1.5 x working pressure, to a maximum of PN + 5 bar.

For pressure testing with gases maximum pressure allowed is 1.5 bar.

Time under Pressure Test:

We recommend that the system is left at the test pressure for minimum 6 hours to ensure complete leak tightness control.

Insulation

Insulating ABS

ABS is not chemically resistant to solvents.

Solvents are used in the jointing process to soften and swell the ABS to create a weld. This use of solvent takes place under controlled conditions and uses double wall thickness by inserting pipe in fitting.

Any other contact of solvents with ABS should be avoided. Some insulation materials on the market use solvent based glues to position the insulation, as per manufacturers' instructions only the insulation itself should be glued together.

Any excess glue which may come into contact directly with the ABS should be removed with a cloth.

If insulation has been glued directly to the pipe this does not mean that the system is now dangerous. It can however only be determined on a case to case basis if the situation will have a detrimental effect on the performance of the pipe. Contact GF Piping Systems if you require more information on this subject.

Insulation to avoid Dew on ABS

To calculate the necessary thickness of insulation required on ABS to avoid Dew or Condensation can be done via GF Piping Systems's on-line cooling calculation program, see www.cool-fit.georgfischer.com

Under the button «condensation» you will be asked to input the system parameters and type

of insulation. The results are guideline values based on tradename published data and general physical data regarding types of insulation. We recommend the user consults the insulation manufacturer for detailed specific advice regarding the insulation when not using COOL-FIT ABS.

COOL-FIT ABS: Condensation, Yes or No?

COOL-FIT ABS has set thicknesses of insulation, once again via www.cool-fit.georgfischer.com the user can input his system parameters and the program will identify whether using COOL-FIT ABS dew will appear on the outside of the pipe or not.

PUR has a thermal conductivity of 0.026 W/m.K and the thickness is +/-35mm for all dimensions so the system parameters need to be extreme for dew to appear on the outside of COOL-FIT ABS.

For example:

Medium temperature:	-50 °C
Temperature of the surrounding	+20 °C
Relative atmospheric humidity	75%
Wind velocity:	1 m/s

Under the above circumstance there will be no condensation on the pipes.

Foaming ABS with PUR On-Site

There are various types of PUR on the market using different types of activators to initiate the foaming process. All are however an exothermic reaction, i.e. generate heat, usually reaching temperatures of about 120 °C, which can be dangerous for thermoplastics. ABS has a vicat point, softening point of 98 °C, this means that any temperatures reached above this have a detrimental effect on the ABS. Also usually the foaming on-site takes place in an enclosed volume which then causes external pressures on the component. For these reasons we recommend that ABS fittings and pipe are not insulated using PUR foaming on-site.

COOL-FIT ABS is foamed under controlled conditions ensuring that the quality of the ABS is not affected by the PUR foaming process.

COOL-FIT ABS Under-Ground

COOL-FIT ABS can be used under-ground. Standard guidelines for laying of plastic pipe systems underground should be followed.

Under normal circumstances it is not necessary to building any expansion loops into the system. Note: avoid movement of the pipe before filling the trench. Please consult GF Piping Systems for recommendations regarding underground installation.

De-Frosting

Many secondary refrigeration loops are not only used for normal and low temperature cooling but are also used for de-frosting. GF Piping Systems has many years of good experience with the use of ABS in such dual de-frost / cooling systems without any detrimental effects to the system.

Long Term Life-Span of ABS Pipes

One of the major differences in physical characteristics between plastics and metals is the physical characteristic creep. Creep is a time related physical property of plastics. Under a constant stress plastics strain and the amount of strain is time related.

This characteristic is taken into account in the Pressure-Temperature curve which is based on a minimum Life-Span of 25 years and with a safety factor of 1.8.

This curve and further background data relating to creep, the long term hydrostatic curves, and other system defining criteria can be found in ISO 15493.

Storage

All plastic pipes including pre-insulated plastic pipes, i.e. COOL-FIT ABS should be stacked on a flat surface free from sharp edges, such as stones or building debris for instance. During handling care should be taken to avoid damage to the outside surface of the pipe, for instance no dragging along the ground. Avoid pipe overhangs when stored as this will cause the pipe to bend.

UV Resistance

Most plastics suffer some loss of physical properties when exposed to UV light, only PE Black, used also for the outer jacket of the COOL-FIT ABS black, is UV resistant.

The impact strength of ABS reduces under UV light over a time period of approximately one year, after which the oxidised layer on the outside surface of the ABS acts as a barrier and the impact strength does not deteriorate further.

Although the ABS impact strength is reduced under UV light it still remains at a very high level.

The Environment

ABS and COOL-FIT ABS are halogen free. The materials used in COOL-FIT ABS namely ABS, PE and PUR are all recyclable materials. GF Piping Systems as a company aims to understand and meet customer requirements regarding the environment. We design products and develop our processes taking into account the environment and its needs.



How to carry COOL-FIT pipes after connection with ABS Nipples:

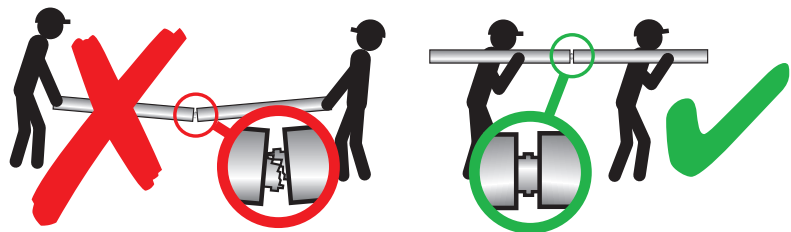

Pipes must be kept straight!



Flammability

A means of measuring flammability is by using the limiting oxygen index (LOI) to ASTM 2863 or BS2782-141. These values are shown below for the COOL-FIT ABS raw materials and for comparison purposes some other commonly used materials.

A material with a LOI value above 21 does not support combustion in air at room temperature.

Material	LOI
ABS	18.3–18.8
PE	17.4
Cotton	16–17

ABS Flammability

According to UL-94, ABS has an HB (Horizontal Burning) flammability coefficient and falls into building material class B2 (conventional inflammable, non-dripping) according to DIN 4102-1. Fundamentally, toxic substances are released by all burning processes. Carbon monoxide is generally the most important. When ABS burns, primarily carbon dioxide, carbon monoxide and water are formed. Tests have shown that the relative toxicity of the products of combustion are similar or even lower than those of natural products such as wood, wool and cotton. ABS combustion gases are not corrosive. That the burning nevertheless forms soot, smoke develops during combustion. Suitable fire-fighting agents are water, foam and carbon dioxide.

PE Flammability

The following classifications in accordance with differing combustion standards: According to UL94, PE is classified as HB (Horizontal Burning) and according to DIN 53438-1 as K2. According to DIN 4102 part 1 and ÖNORM B3800 part 1, PE is listed as B2 (normally flammable). In the French classification of building materials, polyethylene corresponds to M3 (of average flammable rating).

The self-ignition temperature is 350 °C.

Suitable fire-fighting agents are water, foam, carbon dioxide or powder.

PUR Flammability

Rigid polyurethane-based foams are effective insulation materials commonly used in the construction industry.

Polyurethane foam will burn if exposed to flames. The combustibility characteristics vary with chemical composition. Unlike expanded polystyrene (eps), polyurethane does not melt. It flashes into flames between 800 °F and 850 °F, and only chars rather than melts at temperatures below that range. The charring may in fact help protect the adjacent foam. Some studies have indicated that Douglas Fir was more toxic than polyurethane foam.

In a paper presented at the 1985 Society of the Plastics Industry, annual meeting on polyurethane foam. Please consult GF Piping Systems for further details.

ABS Metric Piping System Specification

1 Scope

This specification covers requirements for the GF Piping Systems ABS intended for a wide range of applications including water and wastewater treatment as well as process cooling water and secondary refrigeration.

The components of the ABS pipe system are in accordance with the following standards.

2 Acrylonitrile Butadiene Styrene Material

GF Piping Systems ABS pipes and fittings shall be manufactured from acrylonitrile butadiene styrene, ABS. The raw material used shall be material designed for use with pressure bearing piping systems with long term hydrostatic properties in accordance with ISO 15493, as supplied by GF Piping Systems.

For detailed physical properties see GF Piping Systems literature reference Fi 9030, pages 28–30.

3 ABS Pipe

All ABS pipe shall be metric sizes manufactured in accordance with the requirements of ISO 15493, supplied by GF Piping Systems.

4 ABS Fittings

All ABS fittings shall be metric sizes manufactured by GF Piping Systems or equal, with dimensions and tolerances in accordance with ISO 727 and ISO 15493. All threaded connections shall have pipe threads in accordance with the requirements of ISO 7-1:1994.

5 ABS Valves

All ABS valves shall be metric sizes manufactured by GF Piping Systems or equal in accordance with DIN 3441 Parts 1 to 4.

6 Solvent Cement Jointing and Installation

Should be in accordance with GF Piping Systems Guide to the Installation and Use of Plastic Pipelines.

COOL-FIT ABS Pipe and Fittings Specification

1 Scope

This specification covers requirements for GF Piping Systems COOL-FIT ABS (pre-insulated ABS pipe and fittings), intended primarily for use in refrigeration and cooling plants for the secondary piping systems. The system consists of pre-insulated pipe and fittings using ABS carrier pipe and fittings, with insulation from PUR and outer jacket in PE.

The components of the COOL-FIT ABS pipe and fittings are in accordance with the following standards.

2 ABS Carrier Pipe and Fittings

2.1 Raw Material

GF Piping Systems ABS pipes and fittings shall be manufactured from acrylonitrile butadiene styrene, ABS. The raw material used shall be a material for use with pressure bearing plastic pipe systems in accordance to ISO 15493. For detailed physical properties see GF Piping Systems literature reference Fi 9030, pages 32–34.

2.2 Physical Properties

The ABS carrier pipe and fittings shall be manufactured to metric sizes in accordance with the requirements of ISO 15493, supplied by GF Piping Systems.

3 PUR Insulation

The insulating material shall be hard polyurethane foam, PUR, with a thermal conductivity, λ value, of $< 0.026 \text{ W/mK}$ and a density of $> 45 \text{ kg/m}^3$.

4 HD-PE Outer Jacket

The outer jacket shall be manufactured from HDPE, high density polyethylene, black and white. Colours of the jacket shall be black to RAL 9004 and white to RAL 9010. The black jacket shall be UV resistant in accordance to DIN 8075.

5 Solvent Cement Jointing and Installation

Should be in accordance with GF Piping Systems Guide to the Installation and Use of Plastic Pipelines.

Pipes

Pipes 1m length, ABS metric

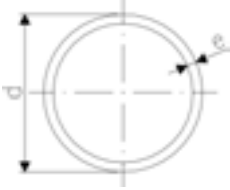

Model:

- Material: ABS
- Colour: RAL 7001, gravel grey
- Length: 1m
- PN 10 (10 bar) / PN 16 (16 bar) at 20°C

d [mm]	PN	Code	kg/m	e [mm]	Length [m]
16	16	700 262 080	0.095	1.8	1.00
20	16	700 262 081	0.152	2.3	1.00
25	16	700 262 082	0.193	2.3	1.00
32	10	700 262 083	0.212	1.9	1.00
40	10	700 262 084	0.334	2.4	1.00
50	10	700 262 085	0.523	3.0	1.00
63	10	700 262 086	0.834	3.8	1.00
75	10	700 262 087	1.176	4.5	1.00
90	10	700 262 088	1.693	5.4	1.00
110	10	700 262 089	2.529	6.6	1.00
140	10	700 262 091	4.489	8.6	1.00
160	10	700 262 092	5.856	9.9	1.00
200	10	700 262 093	9.133	12.3	1.00
225	10	700 262 094	11.605	13.9	1.00

Pipes pre-insulated, ABS metric



Model:

- 5m pipe lengths
- Outer jacket PE-HD
- Black pipe available in small quantities ex stock (extra price)
- White pipe has a lead time of 4-6 weeks

d [mm]	D [mm]	PN	black Code	white Code	kg/m
25	90	10	169 017 682	169 017 782	1.300
32	90	10	169 017 683	169 017 783	1.500
40	110	10	169 017 684	169 017 784	1.900
50	110	10	169 017 685	169 017 785	2.100
63	125	10	169 017 686	169 017 786	2.700
75	140	10	169 017 687	169 017 787	3.500
90	160	10	169 017 688	169 017 788	-
110	180	10	169 017 689	169 017 789	5.500
140	225	10	169 017 691	169 017 791	8.500
160	250	10	169 017 692	169 017 792	10.500
200	280	10	169 017 693	169 017 793	13.500
225	315	10	169 017 694	169 017 794	18.500

Fittings

Bends 90° pre-insulated, ABS metric

Model:

- Outer jacket PE-HD, available in black or white

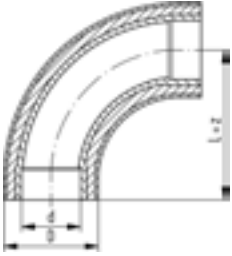

d [mm]	D [mm]	PN	black Code	white Code	kg	z [mm]	L [mm]	required Nipple
25	90	10	738 001 107	738 001 207	0.100	69	69	738 901 607
32	90	10	738 001 108	738 001 208	0.100	86	86	738 901 608
40	110	10	738 001 109	738 001 209	0.300	109	109	738 901 609
50	110	10	738 001 110	738 001 210	0.300	131	131	738 901 610
63	125	10	738 001 111	738 001 211	0.500	164	164	738 901 611
75	140	10	738 001 112	738 001 212	0.700	194	194	738 901 612
90	160	10	738 001 113	738 001 213	1.000	231	231	738 901 613
110	180	10	738 001 114	738 001 214	2.500	281	281	738 901 614
140	225	10	738 001 116	738 001 216	4.500	356	356	738 901 616
160	250	10	738 001 117	738 001 217	6.000	406	406	738 901 617
225	315	10	738 001 120	738 001 220	6.000	287	287	738 901 620

Elbow 45° pre-insulated, ABS metric

Model:

- Outer jacket PE-HD, available in black or white



d [mm]	D [mm]	PN	black Code	white Code	kg	z [mm]	L [mm]	required Nipple
25	90	10	738 151 107	738 151 207	0.100	25	25	738 901 607
32	90	10	738 151 108	738 151 208	0.100	30	30	738 901 608
40	110	10	738 151 109	738 151 209	0.200	36	36	738 901 609
50	110	10	738 151 110	738 151 210	0.200	43	43	738 901 610
63	125	10	738 151 111	738 151 211	0.200	52	52	738 901 611
75	140	10	738 151 112	738 151 212	0.400	61	61	738 901 612
90	160	10	738 151 113	738 151 213	0.500	71	71	738 901 613
110	180	10	738 151 114	738 151 214	0.800	89	89	738 901 614
140	225	10	738 151 116	738 151 216	1.300	108	108	738 901 616
160	250	10	738 151 117	738 151 217	1.800	122	122	738 901 617
200	280	10	738 151 119	738 151 219	2.600	149	149	738 901 619
225	315	10	738 151 120	738 151 220	3.300	168	168	738 901 620

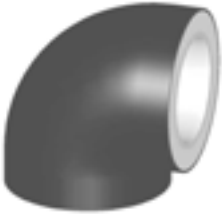

Elbow 90° pre-insulated, ABS metric



Model:

- Outer jacket PE-HD, available in black or white
- Compact design

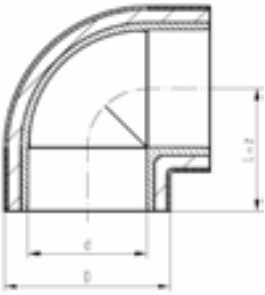

d [mm]	D [mm]	PN	black Code	white Code	kg	z [mm]	L [mm]	required Nipple
160	250	10	738 101 117	738 101 217	2.600	166	166	738901617
200	280	10	738 101 119	738 101 219	3.700	207	207	738901619



Tees 90° pre-insulated, ABS metric

Model:

- Outer jacket PE-HD, available in black or white

* Connecting dimensions = Pipe inner diameter

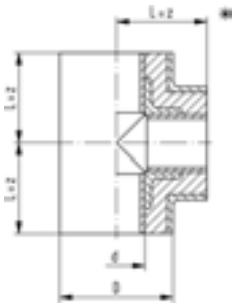
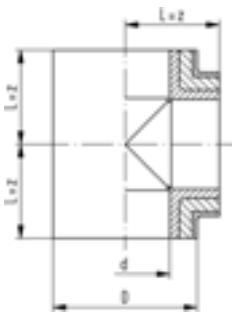

d [mm]	D [mm]	PN	black Code	white Code	kg	z [mm]	L [mm]	required Nipple
*25	90	10	738 201 107	738 201 207	0.100	80	80	738 901 107
*32	90	10	738 201 108	738 201 208	0.100	80	80	738 901 108
*40	110	10	738 201 109	738 201 209	0.100	90	90	738 901 109
*50	110	10	738 201 110	738 201 210	0.200	90	90	738 901 110
*63	125	10	738 201 111	738 201 211	0.400	100	100	738 901 111
*75	140	10	738 201 112	738 201 212	0.600	125	125	738 901 112
*90	160	10	738 201 113	738 201 213	1.000	140	140	738 901 113
110	180	10	738 201 114	738 201 214	2.000	122	122	738 901 614
140	225	10	738 201 116	738 201 216	3.000	147	147	738 901 616
160	250	10	738 201 117	738 201 217	4.000	167	167	738 901 617
200	280	10	738 201 119	738 201 219	5.000	207	207	738 901 619
225	315	10	738 201 120	738 201 220	7.000	233	233	738 901 620



Tees 90° reduced pre-insulated ABS metric



Model:

- Outer jacket PE-HD, available in black or white

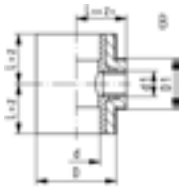
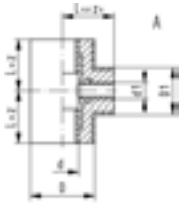

d [mm]	d1 [mm]	D [mm]	D1 [mm]	Type	PN	black Code	white Code
32	25	90	90	A	10	738 201 138	738 201 238
40	25	110	90	A	10	738 201 151	738 201 251
40	32	110	90	A	10	738 201 147	738 201 247
50	25	110	90	A	10	738 201 192	738 201 292
50	32	110	90	A	10	738 201 164	738 201 264
63	25	125	90	A	10	738 201 193	738 201 293
63	32	125	90	A	10	738 201 178	738 201 278
63	50	125	110	A	10	738 201 170	738 201 270
90	32	160	90	B	10	738 201 143	738 201 243
90	63	160	125	B	10	738 201 146	738 201 246
110	32	180	90	B	10	738 201 144	738 201 244
110	50	180	110	B	10	738 201 136	738 201 236
140	50	225	110	B	10	738 201 148	738 201 248
140	75	225	140	B	10	738 201 149	738 201 249
160	90	250	160	B	10	738 201 158	738 201 258
200	110	280	180	C	10	738 201 153	783 201 253
225	110	315	180	C	10	738 201 156	738 201 256
225	160	315	250	C	10	738 201 157	738 201 257

d [mm]	d1 [mm]	z [mm]	z1 [mm]	required Nipple
32	25	80	80	1 x 738 901 107; 2x 738 901 108
40	25	90	90	1 x 738 901 107; 2x 738 901 109
40	32	90	90	1 x 738 901 108; 2x 738 901 109
50	25	90	90	1 x 738 901 107; 2x 738 901 110
50	32	90	90	1 x 738 901 108; 2x 738 901 110
63	25	100	100	1 x 738 901 107; 2x 738 901 111
63	32	100	100	1 x 738 901 108; 2x 738 901 111
63	50	100	100	1 x 738 901 110; 2x 738 901 111
90	32	97	120	1 x 738 901 108; 2x 738 901 613
90	63	97	120	1 x 738 901 111; 2x 738 901 613
110	32	117	130	1 x 738 901 108; 2x 738 901 614
110	50	117	130	1 x 738 901 110; 2x 738 901 614
140	50	147	153	1 x 738 901 110; 2x 738 901 616
140	75	147	153	1 x 738 901 112; 2x 738 901 616
160	90	167	165	1 x 738 901 113; 2x 738 901 617
200	110	213	193	1 x 738 901 614; 2x 738 901 619
225	110	239	206	1 x 738 901 614; 2x 738 901 620
225	160	239	206	1 x 738 901 617; 2x 738 901 620



Tees 45° pre-insulated, ABS metric

Model:

- Outer jacket PE-HD, available only in black

* Connecting dimensions = Pipe inner diameter

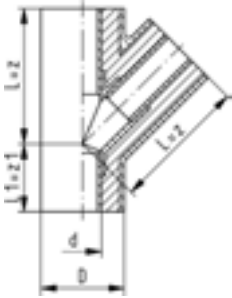

d [mm]	D [mm]	PN	Code	kg	L [mm]	z [mm]	L1 [mm]	z1 [mm]	required Nipple
*25	90	10	738 251 107	0.100	160	160	80	80	738 901 107
*32	90	10	738 251 108	0.200	160	160	80	80	738 901 108
*40	110	10	738 251 109	0.200	180	180	90	90	738 901 109
*50	110	10	738 251 110	0.300	180	180	90	90	738 901 110
*63	125	10	738 251 111	0.500	200	200	100	100	738 901 111
*75	140	10	738 251 112	0.800	240	240	120	120	738 901 112
*90	160	10	738 251 113	1.200	250	250	125	125	738 901 113
*110	180	10	738 251 114	2.200	300	300	150	150	738 901 114



Barrel Nipples di-di, ABS

Model:

- To connect pipe inner diameters di

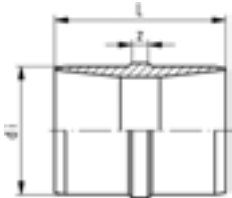

d [mm]	PN	Code	kg	di [mm]	L [mm]	z [mm]
25	10	738 901 107	0.008	20	52	10
32	10	738 901 108	0.014	28	58	10
40	10	738 901 109	0.022	35	66	10
50	10	738 901 110	0.035	44	76	10
63	10	738 901 111	0.060	55	90	10
75	10	738 901 112	0.090	65	102	10
90	10	738 901 113	0.127	79	104	10
110	10	738 901 114	0.208	96	122	10
140	10	738 901 116	0.397	123	150	10
160	10	738 901 117	0.550	141	166	10
200	10	738 901 119	0.990	176	202	10
225	10	738 901 120	1.351	198	224	10



Adaptor Nipples d-di, ABS

Model:

- To connect d to pipe inner diameter di

* Can also be used as a reducer di 160 to di 140

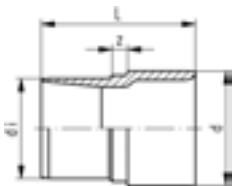

d [mm]	PN	Code	kg	di [mm]	L [mm]	z [mm]
25	10	738 901 607	0.009	20	50	10
32	10	738 901 608	0.016	28	56	10
40	10	738 901 609	0.026	35	64	10
50	10	738 901 610	0.044	44	74	10
63	10	738 901 611	0.080	55	88	10
75	10	738 901 612	0.114	65	100	10
90	10	738 901 613	0.179	79	108	10
110	10	738 901 614	0.321	96	127	10
*140	10	738 901 616	0.497	123	156	10
160	10	738 901 617	0.757	141	174	10
200	10	738 901 619	1.821	176	212	10
225	10	738 901 620	1.854	198	236	10

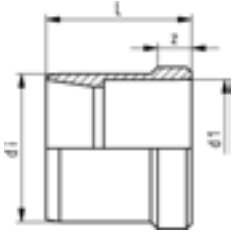

Reducing Nipples di-dred, ABS

Model:

- To connect pipe inner diameter di to reduced dred

d [mm]	d1 [mm]	PN	Code	kg	di [mm]	L [mm]	z [mm]
32	25	10	738 911 341	0.006	28	34	10
40	32	10	738 911 346	0.009	35	38	10
50	40	10	738 911 352	0.014	44	43	10
63	50	10	738 911 358	0.025	55	50	10
75	63	10	738 911 364	0.022	65	56	10
90	75	10	738 911 370	0.033	79	57	10
110	90	10	738 911 376	0.073	96	66	10
140	110	10	738 911 385	0.198	123	80	10
200	160	10	738 911 392	0.453	176	106	10

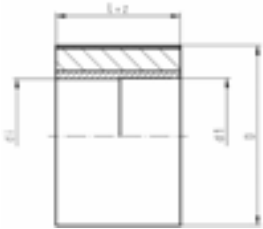

Reducing Bush, pre-insulated, ABS metric



Model:

- To connect di 225 to d 200
- Outer jacket PE-HD, available only in black

d [mm]	d1 [mm]	PN	Code Code	kg	di [mm]	L [mm]	z [mm]
225	200	10	738 911 396	3.924	198	220	220

29 96 04

Hose Connectors, ABS metric

Model:

- With solvent cement spigot metric and parallel hose connection



d [mm]	PN	Code	kg	D [mm]	L [mm]
16	10	729 960 405	0.007	16	57
20	10	729 960 406	0.011	20	73
25	10	729 960 407	0.016	25	79
32	10	729 960 408	0.026	30	89

Accessories

Shrink cap, PE, white

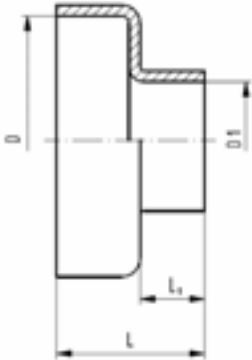

Model:

- To seal dimension reductions on PE
- Can also be used for T 90° reducers
- No sealing tape required (In cap included)
- Attention: Do not shrink onto ABS

D [mm]	D1 [mm]	white Code	kg	L [mm]	L1 [mm]
200 - 140	140 - 90	733 960 235	0.550	149	62
315 - 225	225 - 110	733 960 240	0.900	184	67

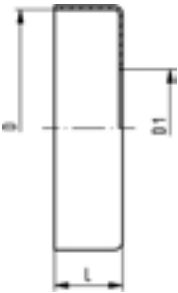

Caps, PE

Model:

- to seal the end of a COOL-FIT pipe to an ABS fitting

D [mm]	D1 [mm]	black Code	white Code	kg	l [mm]
90	24	733 960 171	733 960 271	0.032	35
90	32	733 960 172	733 960 272	0.030	35
110	39	733 960 173	733 960 273	0.041	35
110	48	733 960 174	733 960 274	0.040	35
125	59	733 960 175	733 960 275	0.045	35
140	70	733 960 176	733 960 276	0.054	35
160	83	733 960 177	733 960 277	0.064	35
180	100	733 960 178	733 960 278	0.075	35
225	127	733 960 180	733 960 280	0.102	35
250	144	733 960 181	733 960 281	0.118	35
280	187	733 960 183	733 960 283	0.128	35
315	210	733 960 184	733 960 284	0.153	35



Caps, PE

Model:

- to seal the end of a COOL-FIT pipe to an ABS pipe

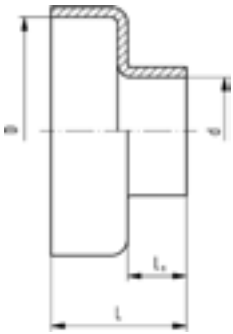

d [mm]	D [mm]	black Code	white Code	kg	L [mm]	L1 [mm]
25	90	733 960 127	733 960 227	0.080	49	14
32	90	733 960 128	733 960 228	0.120	49	14
40	110	733 960 129	733 960 229	0.160	49	14
50	110	733 960 130	733 960 230	0.180	49	14
63	125	733 960 131	733 960 231	0.220	49	14
75	140	733 960 132	733 960 232	0.260	49	14
90	160	733 960 133	733 960 233	0.340	49	14
110	180	733 960 134	733 960 234	0.460	49	14



TANGIT ABS Solvent Cement

- 0,75 l can

Code	kg
799 298 022	0.650



Silicon Glue

Model:

- For sealing and glueing caps
- Tube à 50 ml
- Cartridge à 290 ml

	Code	kg
50 ml	738 011 102	0.100
290 ml	738 011 103	0.400



Gap filler

- 13 x 13mm, 2.5 m on a roll
- To insulate inspection gap at joints



d-d [mm]	Code	kg
25 - 225	738 011 150	0.050



Sealing tape

- To provide a water tight seal in combination with sealing tape
- 35mm, 80 m on a roll

d-d [mm]	Code	kg	
25 - 225	738 011 151	5.000	



Shrink sleeve short, white, PE

- To provide a water tight seal in combination with sealing tape. For connections of the same outer diameter (D).
- Length = 85mm

D [mm]	white Code	kg	L [mm]	
90	738 011 213	0.045	85	
110	738 011 214	0.055	85	
125	738 011 215	0.060	85	
140	738 011 216	0.070	85	
160	738 011 217	0.080	85	
180	738 011 218	0.090	85	
225	738 011 220	0.110	85	
250	738 011 221	0.120	85	
280	738 011 222	0.140	85	
315	738 011 223	0.160	85	



Shrink sleeve short, black, PE

- To provide a water tight seal in combination with sealing tape. For connections of the same outer diameter (D).
- Length = 85mm

D [mm]	Code Code	kg	
90 - 110	738 011 131	0.045	
125 - 160	738 011 132	0.060	
180 - 225	738 011 133	0.090	
250 - 315	738 011 134	0.120	

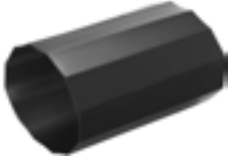

Shrink sleeve long, PE

Model:

- To provide a water tight seal in combination with sealing tape
- For straight connections only
- D-D1 connections can be realized with the sleeves listed in the table below
- Length: 265 mm

black Code	white Code	kg	L [mm]
738 011 167	738 011 267	0.210	265
738 011 170	738 011 270	0.300	265
738 011 173	738 011 273	0.420	265

Table black

	D 110	D 125	D 140	D 160	D 180	D 225	D 250	D 280	D 315
D1 90	738.011.167	738.011.167	738.011.167	738.011.167					
D1 110		738.011.167	738.011.167	738.011.167					
D1 125			738.011.167	738.011.167					
D1 140				738.011.167	738.011.170	738.011.170			
D1 160					738.011.170	738.011.170			
D1 180						738.011.170	738.011.173	738.011.173	
D1 225							738.011.173	738.011.173	738.011.173
D1 250								738.011.173	738.011.173
D1 280									738.011.173

Table white

	D 110	D 125	D 140	D 160	D 180	D 225	D 250	D 280	D 315
D1 90	738.011.267	738.011.267	738.011.267	738.011.267					
D1 110		738.011.267	738.011.267	738.011.267					
D1 125			738.011.267	738.011.267					
D1 140				738.011.267	738.011.267				
D1 160					738.011.267				
D1 180						738.011.270	738.011.270	738.011.273	
D1 225							738.011.270	738.011.273	738.011.273
D1 250								738.011.273	738.011.273
D1 280									738.011.273



Shrink cap, PE, black

Model:

- To seal dimension reductions on PE
- Can also be used for T 90° reducers
- No sealing tape required (In cap included)
- Attention: Do not shrink onto ABS

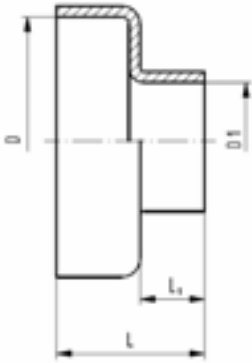

D [mm]	D1 [mm]	black Code	kg	L [mm]	L1 [mm]
225 - 160	140 - 90	733 960 135	0.550	137	61
315 - 225	250 - 125	733 960 140	0.900	143	43



Pipe Clips Type 060, PP metric

Model:

- For mm pipes d90-400
- Material: Clip and safety clip PP black, UV resistant
- Accidental opening of the safety clip is not possible
- **Minimum order quantity: standard packaging SP or gross packaging GP**
- Clip and safety clip are not assembled in the packaging.
- Pipes with flanges can be installed directly

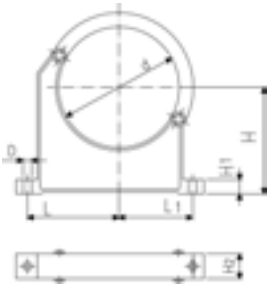

d [mm]	Code	kg	D [mm]	L [mm]	L1 [mm]	H [mm]	H1 [mm]	H2 [mm]	SC
90	167 060 038	0.163	9	89	71	105	15	33	M 8
110	167 060 039	0.179	9	94	80	115	15	33	M 8
125	167 060 040	0.300	11	116	91	130	20	35	M10
140	167 060 041	0.309	11	121	98	130	20	35	M10
160	167 060 042	0.348	11	131	107	148	20	35	M10
180	167 060 043	0.378	11	143	115	163	20	35	M10
200	167 060 019	0.582	13	152	120	175	25	39	M12
225	167 060 020	0.612	13	165	132	175	25	39	M12
250	167 060 021	0.698	13	183	143	200	25	39	M12
280	167 060 022	0.722	13	198	156	200	25	39	M12
315	167 060 023	0.842	13	219	172	225	25	39	M12
355	167 060 024	1.250	17	275	209	258	30	50	M16
400	167 060 025	1.450	17	300	228	288	30	50	M16



Repairing Tape , PE

Model:

- For later closing of gaps instead of shrink sleeve
- 1150mmx150mm, black

d-d [mm]	Code	kg
25 - 225	738 011 104	1.500



COOL-FIT Chamfering Tool

Model:

- To calibrate pipe inner diameters of COOL-FIT pipes
- Including transportation case

d-d [mm]	Code	kg	
140 - 225	790 205 001	19.500	



Shrink tape black, PE



Model:

- For later closing of gaps
- Mastic backed
- Width (L) available in 100mm or 300mm
- 10 m on a roll

d-d [mm]	Code Code	kg	L [mm]	
25 - 225	738 011 105	1.000	100	
25 - 225	738 011 106	3.000	300	

29 90 03

Reducing Bush, ABS metric

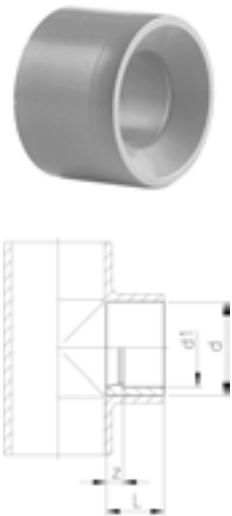

d [mm]	d1 [mm]	PN	Code	kg	z [mm]	L [mm]	
20	16	16	729 900 334	0.003	2	16	
25	20	16	729 900 337	0.005	3	19	
32	20	10	729 900 342	0.012	6	22	
32	25	10	729 900 341	0.009	4	22	
40	20	10	729 900 348	0.016	10	26	
40	25	10	729 900 347	0.016	7	26	
40	32	10	729 900 346	0.012	4	26	
50	20	10	729 900 355	0.024	15	31	
50	25	10	729 900 354	0.025	12	31	
50	32	10	729 900 353	0.035	9	31	
50	40	10	729 900 352	0.038	5	31	
63	32	10	729 900 360	0.060	16	38	
63	40	10	729 900 359	0.067	12	38	
63	50	10	729 900 358	0.044	7	36	
75	50	10	729 900 365	0.105	13	44	
75	63	10	729 900 364	0.076	7	44	
90	50	10	729 900 372	0.136	20	51	
90	63	10	729 900 371	0.130	14	51	
90	75	10	729 900 370	0.133	7	51	
110	63	10	729 900 378	0.238	24	61	
110	90	10	729 900 376	0.196	10	61	
140	110	10	729 900 385	0.454	15	76	
160	110	10	729 900 390	0.666	25	86	
160	140	10	729 900 388	0.416	10	86	
200	160	10	729 900 392	0.818	20	106	
225	160	10	729 900 396	1.640	33	119	
250	225	6	729 900 303	1.000	12	131	
280	250	6	729 900 306	2.500	15	146	
315	280	6	729 900 312	3.350	17	164	

Instructions for Solvent Cement Jointing of ABS

General

Solvent cement jointing calls for adequate technical knowledge, which can be acquired in the appropriate training courses. Your GF Piping Systems representative will gladly provide you with information about training possibilities.

The dimensions of GF Piping Systems pipes, fittings and valves conform generally to the various national standards as well as to ISO 727 concerning dimensions of sockets. Our fittings and valves can be used with any ABS pipes whose outside diameter tolerance conforms to ISO 15493.

According to ISO 727 the following minimal cement lengths are valid:

Pipe outside diameter – Socket inside diameter d (mm)	Minimal cement length L (mm)
12	12.0
16	14.0
20	16.0
25	18.5
32	22.0
40	26.0
50	31.0
63	37.5
75	43.5
90	51.0
110	61.0
125	68.5
140	76.0
160	86.0
200	106.0
225	118.5



Cutting the pipe to length



Chamfering the pipe



Solvent cementing equipment

Tools and equipment

Pipe cutter	d 10–63	790 109 001	
Type KRA	d 50–110	790 109 002	
	d 110–160	790 109 003	
	230 V/50 Hz	790 201 001	
Plastic pipe cutter	120 V/60 Hz	790 201 002	
	110 V/50 Hz	790 201 003	
Type KRT 250	d 16–75	799 495 145	
	d 32–200	799 495 146	
Chamfering tool			
Cleaner	799 298 010 (1 litre tin)		
Tangit ABS Solvent Cement	799 298 022 (0.65 kg tin)		
Brush sizes	Pipe outside diameter in mm	Brush	Code-No.
	6– 10	Round brush ø 4 mm	799 299 001
	12– 32	Round brush ø 8 mm	799 299 002
	40– 63	Flat brush 25 x 3 mm	799 299 003
	75–225	Flat brush 50 x 5 mm	799 299 004
Tin lid	799 298 028		
White absorbent paper	commercially available		
Solvent resistant protecting gloves	commercially available		

Preparations

The pipe must be cut off at right angles. Remove the inside edges and chamfer the outside ones as illustrated in the sketch. Only then is an optimal solvent cemented joint possible.

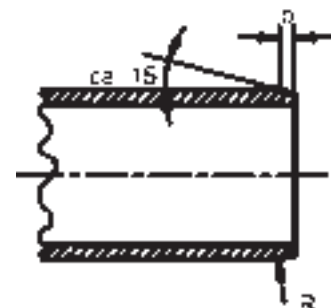

Pipe outside diameter mm	b mm
6–16 mm	1–2 mm
20–50 mm	2–3 mm
≥ 63 mm	3–6 mm

Important: Well-chamfered pipe ends prevent the layer of cement from being removed as the pipe is inserted into the fitting.

Wipe the outside of the pipe and the inside of the socket with a clean cloth to remove obvious dirt. Marking the jointing length on the pipe end makes it possible to check afterwards whether the pipe has been inserted to the full extent of the socket.



Marking the jointing length

Note: If the outside diameter of the pipe and the inside diameter of the socket are at opposite extremes of their tolerances, then the pipe cannot be inserted dry into the fitting socket. This will only become possible once the cement has been applied.

The Tangit ABS Cement is supplied ready for use. Stir thoroughly before using! Cement of the correct consistency will run evenly from a wooden spatula held at a slant. Cement which no longer runs smoothly is unusable. The cement must not be thinned. Cement and cleaner should be stored in a cool, dry place (5–25 °C)!



Checking the cement

Cementing

For surfaces which are clean and free from grease, cleaning with absorbent paper and Tangit cleaner is not necessary for ABS. For surfaces not in perfect condition clean the outside of the pipe end and the inside of the socket **thoroughly** with ABS Cleaner and absorbent paper. Use a fresh piece of paper for each component. Remove any condensation which may have formed on the parts.



Cleaning the pipe and socket

Important: Pipe end and fitting socket must be dry and free from grease and dirt and must not be touched after cleaning.

ABS pipes should be cemented at temperatures between –5 °C and +40 °C. Take the following protective measures if the temperatures deviate from the above:

At temperatures near freezing point condensation or ice water which may have formed must be removed, e. g. with warm air. Cement and cleaner should be stored at room temperature. Completed joints must be left at 20–30 °C for approximately 10 minutes to condition.

Avoid overheating when cementing at higher temperatures by protecting the jointing area from direct sunlight.

The quick curing time of the cement necessitates that the joint is made within 1 minute after application of the cement has started. The opening time of the ABS cement varies with the ambient temperature and/or the thickness (1 mm) of the cement applied:

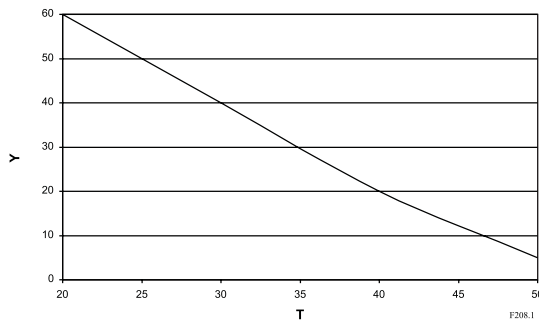

T Temperature [°C]

Y Open time [sec]

Begin by applying a normal layer of cement to the fitting socket and then a thicker one to the pipe end with firm brush pressure. **Work in well.** The brush strokes should always be in an axial direction.

To ensure that both jointing surfaces are completely covered with a smooth, even layer of cement, the brush should be generously loaded with cement.

The joints can be made single handed for pipes with diameters up to d63 mm.



Applying the cement

For d75 mm and larger pipes, two people are needed to apply the cement to the pipe end and fitting socket simultaneously in order to avoid exceeding the maximum opening time of the cement of 1 minute.

After the cement has been applied insert the pipe to the full depth of the socket immediately without twisting and bring them into the correct alignment. Ensure that the outlet of the fitting is in the correct position. Hold them briefly in this position to allow the cement to set. Wait at least 10 minutes before the next joint, extend the waiting time at temperatures under 10 °C to 15 minutes.

Remove any surplus cement immediately, using absorbent paper.

A bead of excess solvent cement around the complete external circumference of the joint and a slightly smaller bead again around the complete internal circumference show that the joint has been performed correctly.

After use clean the brush of excess cement with dry absorbent paper and then clean thoroughly using TANGIT cleaner. Brushes must be dry before being re-used (shake out).

Replace the lid of the cement tin after use to prevent the solvent evaporating. Using the conical lid allows to leave the brush in the cement tin during breaks.



Replace the lid of the cement tin during work breaks



The pipe trench is not a rubbish tip

Both solvent cement and cleaner dissolve ABS. Pipes and fittings must not therefore be laid on or allowed to come into contact with spilled cement or paper containing cement residues.

It is recommended to scavenge the pipeline after finishing, and leave it filled with water if it is not directly used. Do not use compressed air for scavenge.

Drying period and pressure testing

The length of drying period before the joint may be subjected to testing or operating pressure depends on the ambient temperature and the tolerances.

A longer waiting time should be applied when temperatures exceed ambient. Generally the waiting time after the last joint until the pressure test at a testing pressure of 15 bar (PN10) must be at least 24 hours. If the pipe is only subjected to the operating pressure, e. g. after adaptation or repair works, the following rule of thumb for the drying period applies:

1 hour waiting time per bar operating pressure at temperatures of up to 25 °C.

For waiting times at higher temperatures please consult your local GF Piping Systems Representative.

Safety precautions

Tangit Cement and Tangit Cleaner contain highly volatile solvents. This makes good ventilation or adequate fume extraction essential in closed spaces. Since the solvent fumes are heavier than air, extraction must occur at floor level, or at least below the working level. Place paper which has been used for cleaning or for the removal of surplus cement into closed containers to minimize the amount of solvent fumes in the air.



Adequate ventilation of the workplace

Cement and cleaner are inflammable. Extinguish open fires before commencing work. Switch off unprotected electrical apparatus, electric heaters, etc. Do not smoke! Discontinue any welding operations. Furthermore, observe all instructions issued by the solvent cement manufacturer (e. g. label of the tin and any supplementary documentation).



No naked flames when cementing
No smoking

Protect pipes and fittings from spilled solvent cement, cleaner and absorbent paper which has been used to wipe off cement. Do not dispose of surplus solvent cement or cleaner in drainage systems.

The use of protective gloves is recommended to avoid contact of the skin with solvent cement and cleaner. If the cement or the cleaner get in contact with eyes, rinse immediately with water. Consult a doctor! Immediately change clothes that have solvent cement on them.

Always obey the safety regulations issued by the authorities responsible.

Do not close off cement pipelines during the drying process. This is particularly important at temperatures below +5 °C, when there is otherwise a danger of damaging the material.

ABS Tangit and Cleaner: Amounts required

d (ABS) mm	Socket Length mm*	ABS Tangit- Amount per 100 Joints kg	ABS Tangit Number of Joints per Tin 0.650 kg	Tangit-Cleaner Amount per 100 Joints litre	Tangit-Cleaner Number of Joints per Tin (1 litre)
16	14	0,25	260	0,09	1111
20	16	0,35	186	0,18	556
25	18,5	0,40	163	0,3	333
32	22	0,45	144	0,5	200
40	26	0,60	108	0,7	143
50	31	0,90	72	0,9	111
63	37,5	1,10	59	1,1	91
75	43,5	1,25	52	1,3	77
90	51	1,70	38	1,45	69
110	61	2,50	26	1,7	59
140	76	5,00	13	2,1	48
160	86	6,47	10	2,5	40
200	106	9,96	7	3,5	29
225	118,5	12,53	5	4,5	22
250	131	15,39	4	5,5	18
280	146	19,21	3	6,5	15
315	163,5	24,20	3	7	14

* The socket length can be calculated using the following simple formula: $\frac{d}{2}+6$

COOL-FIT ABS: Gap Filler and Sealing Tape, amounts required per joint

COOL-FIT ABS Dimension			Gap Filler	Sealing Tape
ABS (d)		PE (D)	(m)	(m)
25	x	90	0,5	0,3
32	x	90	0,5	0,3
40	x	110	0,6	0,4
50	x	110	0,6	0,4
63	x	125	0,6	0,4
75	x	140	0,7	0,5
90	x	160	0,8	0,5
110	x	180	0,9	0,6
140	x	225	1,1	0,7
160	x	250	1,3	0,8
200	x	280	1,5	0,9
225	x	315	1,7	1

Instructions for Solvent Cementing COOL-FIT ABS

The jointing technique for COOL-FIT ABS internal jointing follows the same tried and tested technique as that for standard ABS using exactly the same tooling and Tangit cement.

Following is a summary of ABS solvent cement jointing for COOL-FIT ABS. Please refer to the standard ABS solvent cementing jointing instructions for exact curing times, handling instructions, health and safety advice and commissioning procedure.



Chamfer to 45° the internal diameter of the ABS pipe.

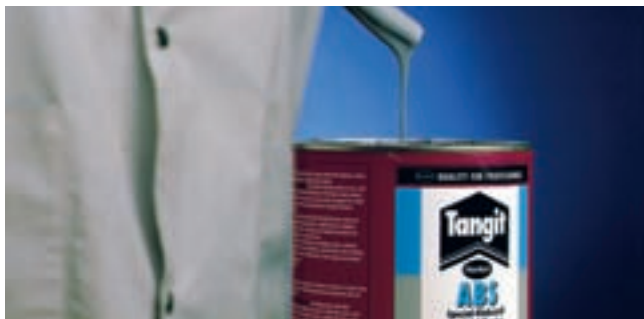

Check the consistency of the ABS Tangit cement. The cement should run smoothly and before jointing check that all tools required are readily at hand.



For surfaces not in perfect condition clean the outside surface of the COOL-FIT ABS nipple and the inner surfaces of the COOL-FIT ABS pipe, using Tangit cleaner with clean absorbent paper.



Mark the inside diameter of the pipe to the minimum socket depth required. Socket depth is always $d/2 + 6$ (mm), for example socket length for $d90 = 51$ mm ($90/2 + 6$).



Apply the ABS cement to the outside of the COOL-FIT ABS nipple, axially, smoothly in one action, in an even layer, approximately 1 mm thick. Use a firm pressure on the brush when applying the cement to work the cement into the fitting.



Apply the ABS Cement to the inside surface of the COOL-FIT ABS pipe. Apply the cement to the depth marked, using the same technique as with the fitting.

Insert the COOL-FIT ABS nipple axially into the pipe being careful not to rotate the parts. Remove all excess cement using absorbent paper.

The installer should take note of the Tangit ABS opening time and safety precautions written on the Tangit tin and in standard ABS jointing instructions.

Joining technique: Pipe preparation

[Calibration only required for $d \geq 90$]



- 1 Cut pipe at right angles, 90°.

For ABS dimensions $< d90$ calibration of the pipe is not required, please follow cementing instructions.

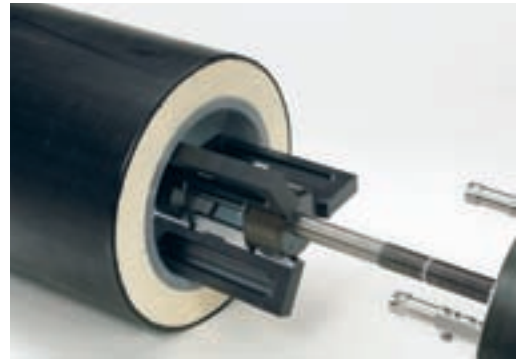

- 4 Insert the tool into the pipe to the depth indicated on the spindle. For short lengths of pipe see instructions packed with the tool.



- 2 For dimensions $\geq d90$ the internal diameter of the pipe needs to be calibrated using the COOL-FIT ABS calibration tool.



- 5 Wind-out the jaws of the tool until the tool is firmly located.



- 3 Assemble the COOL-FIT ABS calibration tool using the relevant parts for the required dimension. Detailed instructions are delivered with the tool.



- 6 Wind-in cutting head checking that the cutting knife and the other 2 locating heads are assembled in the correct location.

Joining technique: Pipe preparation



7 Please note that the tool calibrates the pipe and therefore may not always remove material and may remove different amounts of material as it cuts.



10 Wind-in the locating jaws until the tool is loose then carefully retract the tool taking care not to damage the pipe.



8 The cutting knife can be rotated to cut with a fresh edge if the knife becomes blunt or if it is damaged.

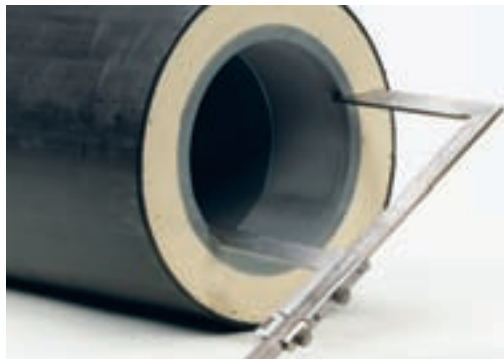

11 It is recommended that the installer checks the diameter of the calibrated pipe at regular intervals, the internal diameters required are listed in the COOL-FIT ABS catalogue and in the tooling instructions.



9 Wind-in the cutting head until it butts up to the end of the pipe.



more than one calibration process must not be performed

Instructions for Insulating the Gap

Please take care that the «shrink sleeve, short» has been placed over the pipe before jointing.



If it is not possible to use the shrink sleeve or the sleeve is damaged GF Piping Systems has a «sealing wrap», effectively a high-duty tape available on demand.

It is also possible to use other heavy-duty insulating tapes instead of the shrink sleeve. For the life-span and sealing properties of these tapes please consult the individual manufacturers.

Place the shrink sleeve over the middle of the gap. Locate the sleeve by pressing it onto the double sided sticky tape.



Wrap the «gap insulator» into the gap between the COOL-FIT ABS components taking care to ensure that the gap is completely filled.



Using an open flame apply heat to the sleeve, taking care to keep the flame moving to avoid the sleeve melting.

To avoid the sleeve distorting apply the heat to the middle of the sleeve, not from the side.

The sleeve will now shrink to the outside diameter of the jacket pipe.

Note: hot air can be used to shrink the sleeve but is not recommended due to the high amount of energy required to activate shrinking.



Apply the double sided sealing tape around the complete circumference of the outer pipe.

ABS Product Range



Background Information to the ABS Product Range from GF Piping Systems

ABS from GF Piping Systems is a pressure bearing complete piping system that has been available from GF Piping Systems since the mid 80's.

GF Piping Systems offers 2 standard systems in ABS; firstly a BS Inch dimensioned system and secondly a metric mm dimensioned system. See ISO15493 for details.

ABS metric is available in dimensions from d16 to d315 with a complete range of fittings and transition fittings for metal to plastic connections as well as a complete range of manually and actuated valves. COOL-FIT ABS is only available using the metric ABS system. The ABS valves are completely corrosion resistant with no metal parts and can be actuated either pneumatically or electrically.



ABS metric can be used for mediums at temperatures between $-40\text{ }^{\circ}\text{C}$ to $+60\text{ }^{\circ}\text{C}$ and has a nominal pressure rating of PN10 (10 bar water at $20\text{ }^{\circ}\text{C}$).

Examples of application areas are: refrigeration secondary systems, for instance in supermarkets or breweries, iced-water or ice slurry systems in pharmaceutical plants, water treatment plants, for drinking and cooling water on ships. Many other application areas are possible. Please ask GF Piping Systems for recommendations of suitability.

COOL-FIT ABS

- Top Quality
- Minimum On Site Time

pre-insulated plastic piping system

Australia

George Fischer Pty Ltd
Unit 1, 100 Belmore Road
Riverwood NSW 2210 Australia
Phone +61(0)2/9502 8000
australia.ps@georgfischer.com
www.georgfischer.com.au

Austria

Georg Fischer
Rohrleitungssysteme GmbH
3130 Herzogenburg
Phone +43(0)2782/856 43-0
austria.ps@georgfischer.com
www.georgfischer.at

Belgium / Luxembourg

Georg Fischer NV/SA
1070 Bruxelles/Brüssel
Phone +32(0)2/556 40 20
be.ps@georgfischer.com
www.georgfischer.be

Brazil

George Fischer Ltda
04795-100 São Paulo
Phone +55(0)11/5687 1311
br.ps@georgfischer.com

China

Georg Fischer
Piping Systems Ltd Shanghai
Pudong, Shanghai 201319
Phone +86(0)21/58 13 33 33
china.ps@georgfischer.com
www.cn.piping.georgfischer.com

Denmark / Iceland

Georg Fischer A/S
2630 Taastrup
Phone +45 (0)70 22 19 75
info.dk.ps@georgfischer.com
www.georgfischer.dk

France

Georg Fischer SAS
Bâtiment Le Rabelais Paris Nord 2
22 Avenue des Nations
BP 88026 Villepinte
95932 Roissy Charles de Gaulle Cedex
Phone +33(0)1 41 84 68 84
fr.ps@georgfischer.com
www.georgfischer.fr

Germany

Georg Fischer GmbH
73095 Albershausen
Phone +49(0)7161/302-0
info.de.ps@georgfischer.com
www.vgd.georgfischer.de

India

Georg Fischer Piping Systems Ltd
400 076 Mumbai
Phone +91 224007 2001
in.ps@georgfischer.com
www.georgfischer.in

Italy

Georg Fischer S.p.A.
20063 Cernusco S/N (MI)
Phone +3902/921 861
it.ps@georgfischer.com
www.georgfischer.it

Japan

Georg Fischer Ltd
556-0011 Osaka,
Phone +81(0)6/6635 2691
jp.ps@georgfischer.com
www.georgfischer.jp

Korea

Georg Fischer Piping Systems
#902 Ace Techno-Tower III
197-48, Guro-dong, Guro-gu
Seoul 152-050 Korea
Phone +82 2 851 3861/3862
Fax +82 2 851 3844
kor.ps@georgfischer.com

Malaysia

Georg Fischer (M) Sdn. Bhd.
47500 Subang Jaya
Phone +60 (0)3-8024 7879
conne.kong@georgfischer.com.my

Middle East

Georg Fischer Piping Systems
Dubai, United Arab Emirates
Phone +971 4 289 41 20
gfdubai@emirates.net.ae
www.piping.georgfischer.com

Netherlands

Georg Fischer N.V.
8161 PA Epe
Phone +31(0)578/678 222
nl.ps@georgfischer.com
www.georgfischer.nl

Norway

Georg Fischer AS
1351 Rud
Phone +47(0)67 18 29 00
no.ps@georgfischer.com
www.georgfischer.no

Poland

Georg Fischer Sp. z o.o.
02-226 Warszawa
Phone +48(0)22/313 10 50
poland.ps@georgfischer.com
www.georgfischer.pl

Romania

Georg Fischer
Piping Systems Ltd
020257 Bucharest - Sector 2
Phone +40(0)21/230 53 80
ro.ps@georgfischer.com

Russia

Georg Fischer Piping Systems
Office 14a, 3 Entrance, 9 Floor
Business Center Parus
1st Tverskaya-Yamskaya Street, 23
Moscow 125047
Tel. +7 495 258 60 80
ru.ps@georgfischer.com

Singapore

George Fischer Pte Ltd
528 872 Singapore
Phone +65(0)67 47 06 11
sgp.ps@georgfischer.com
www.georgfischer.com.sg

Spain / Portugal

Georg Fischer S.A.
28046 Madrid
Phone +34(0)91/781 98 90
es.ps@georgfischer.com
www.georgfischer.es

Sweden / Finland

Georg Fischer AB
12523 Älvsjö-Stockholm
Phone +46(0)8/506 775 00
info.se.ps@georgfischer.com
www.georgfischer.se

Switzerland

Georg Fischer
Rohrleitungssysteme (Schweiz) AG
8201 Schaffhausen
Phone +41(0)52 631 30 26
ch.ps@georgfischer.com
www.piping.georgfischer.ch

Taiwan

Georg Fischer Piping Systems
2F, No. 88, Hsing Te Road
San Chung City
Taipei Hsien, Taiwan (R.O.C.)
Phone +886 2 8512 2822
Fax +886 2 8512 2823

United Kingdom / Ireland

George Fischer Sales Limited
Coventry, CV2 2ST
Phone +44(0)2476 535 535
uk.ps@georgfischer.com
www.georgfischer.co.uk

USA / Canada / Latin America / Caribbean

George Fischer Inc.
Tustin, CA 92780-7258
Phone +1(714) 731 88 00
Toll Free 800/854 40 90
us.ps@georgfischer.com
www.us.piping.georgfischer.com

Export

Georg Fischer
Piping Systems (Switzerland) Ltd.
8201 Schaffhausen
Phone +41 (0)52-631 30 26
Fax +41 (0)52-631 28 93
export.ps@georgfischer.com
www.piping.georgfischer.ch