

# Variable speed motors VARMECA



## General information



VARMECA, is the result of long experience in variable speed, and benefits from a compact dimension and reduced weight, it is currently available up to 11 kW. VARMECA produces no noise pollution thanks to the choice of an inaudible switching frequency. Three phase enclosed variable speed motors in accordance with the IEC Low Voltage Directive (€ C).

Power: 0.25 to 11 kW in frame sizes from 71 to 160. VARMECA offers great operating flexibility due to its parameter setting option: by microconsole or PC ; and process management using international standard communication systems (Profibus, Interbus S, DeviceNet, ...).

## Construction

### VARMECA description

Designations	Remarks
Construction	<ul style="list-style-type: none"> <li>- IP 65 protection, class F</li> <li>- Aluminium box and polyamide cable gland</li> <li>- Screw regarding lids that cannot be lost</li> <li>- Connection regarding power and order cables on flexible blades connector</li> <li>- Electronic device encapsulated in the resin in order to assure a good mechanical handling and immunity to humidity</li> </ul>
Specifications	<ul style="list-style-type: none"> <li>- Single-phase mains:                             <ul style="list-style-type: none"> <li>• Supply: 200 V -10 % to 240 V +10 % 50-60 Hz ±2 %</li> <li>• Output voltage: from 0 V to the supply voltage</li> <li>• Power range: 0.25 - 0.37 - 0.55 - 0.75 - 0.9 - 1.1 - 1.5 kW</li> <li>• Maximal number of power ups by hour: 10</li> </ul> </li> <li>- Three-phase mains:                             <ul style="list-style-type: none"> <li>• Supply: 200 V -10 % to 480 V +10 % 50-60 Hz ±2 %</li> <li>• Tension de sortie : de 0 V à la tension d'alimentation</li> <li>• Output voltage: 0.25 - 0.37 - 0.55 - 0.75 - 0.9 - 1.1 - 1.5 - 1.8 - 2.2 - 3 - 4 - 5.5 - 7.5 - (7.5 kW maximum for mains 230 V) - 9 - 11 kW</li> <li>• Maximal number of power ups by hour: 100</li> </ul> </li> </ul>
Environment	<ul style="list-style-type: none"> <li>- Stockage temperature: -40°C to +70°C (IEC 68.2.3). In compliance with the IEC 60068-2-1 standard.</li> <li>- Transportation temperature: -40°C to +70°C</li> <li>- Operating temperature: -20°C to +50°C (with a derating of 1 % of power by °C, beyond 40°C)</li> <li>- Altitude: &lt; 1000 m without derating The maximum authorized altitude is 4000 m, but beyond 1000 m, the permanent output current has to be derated with 1 % by a segment of 100 m additional below 1000 m (ex.: for an altitude of 3000 m, derate with 20 %).</li> <li>- Ambient humidity: 95 % without condensation</li> <li>- Humidity during the storing: 93 %, 40°C, 4 days</li> <li>- Vibrations:                             <ul style="list-style-type: none"> <li>• Non wrapped product: 0.01 g<sup>2</sup>/Hz 1hr according to the IEC 60068-2-34 standard.</li> <li>• Sinusoidal vibrations:                                     <ul style="list-style-type: none"> <li>- VMA 31/32: 2-9 Hz 3.5 ms<sup>-2</sup> - 9-100 Hz 10 ms<sup>-2</sup></li> <li>- VMA 33/34 : 2-6 Hz 3.5 ms<sup>-2</sup> - 6-100 Hz 5 ms<sup>-2</sup></li> </ul> </li> </ul> </li> <li>according to the IEC 60068-2-6 standard.</li> <li>- Shocks: Wrapped product: 15 g, 6 ms, 500 times/direction in the 6 directions according to the IEC 60068-2-29 standard.</li> <li>- Immunity: According to the EN 61000-6-2</li> <li>- Conducted and radiant emissions:                             <ul style="list-style-type: none"> <li>• In compliance with the EN 61000-6-4 as standard in VMA 31-32 and with industrial filter</li> <li>• In compliance with the EN 61000-6-3 with internal filter option CEM in VMA 31/32</li> </ul> </li> <li>- UL standards:                             <ul style="list-style-type: none"> <li>• In compliance with the UL 508 C (E211799) and c  US</li> </ul> </li> </ul>
Painting	<ul style="list-style-type: none"> <li>- system Ia, colour RAL 6000 (green)</li> </ul>

# Variable speed motors VARMECA



## Mounting positions

### VARMECA motors with foot mounted

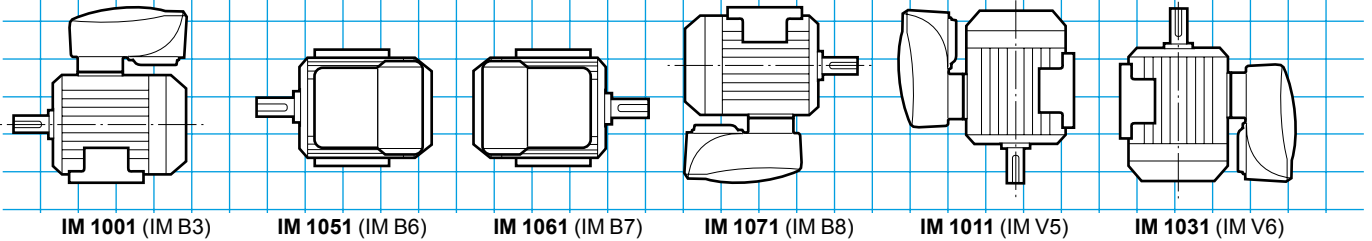

### VARMECA motors with (FF) flange plain holes

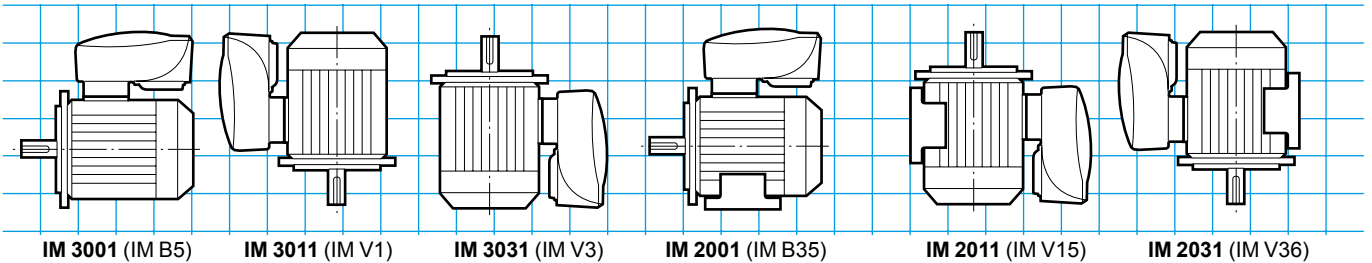

### VARMECA motors with (FT) flange tapped holes

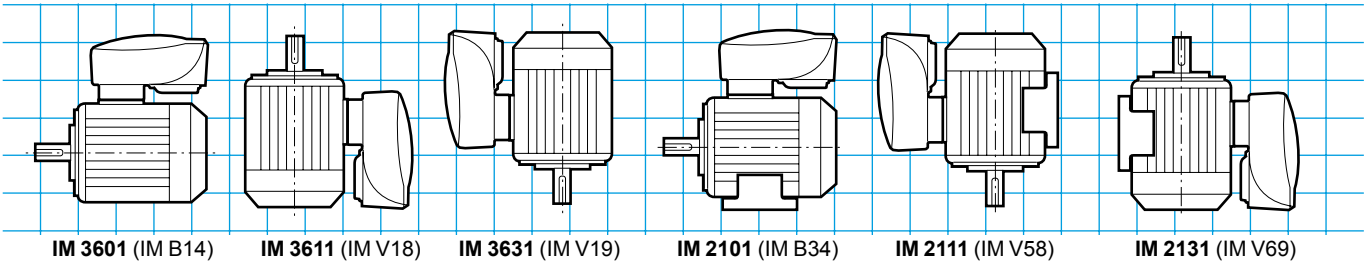

### VARMECA positions

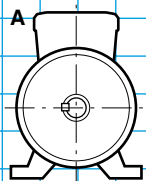

Fixation feet mount motor  
A: standard

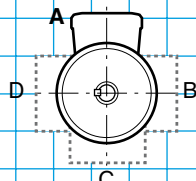

Fixation flange motor  
A: standard

### Cable glands positions

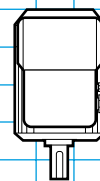

1: standard

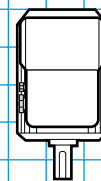

3

# Variable speed motors VARMECA



## Adaptation possibilities

Leroy-Somer suggests, combined with VARMECA variable speed, three-phase and closed motors, more options that answer to very diverse applications. They are described afterwards and in the chapters referring to gearboxes.

For other alternatives or any specific adaptation, consult Leroy-Somer technical specialists.

**The three-phase variable speed motors VARMECA can be associated with:**

- speed gearboxes
- pumps

**The options:**

- drip cover
- encoder
- stainless steel plate
- second shaft extension
- non standard flanges
- speed adjustment button
- Run/Stop order
- forward Run/Reverse Run/Stop order
- integrable RFI filter
- CVI VMA order (adjustment potentiometers)
- FCR J01 brake
- external options (potentiometer, speed digital indicator, ...)

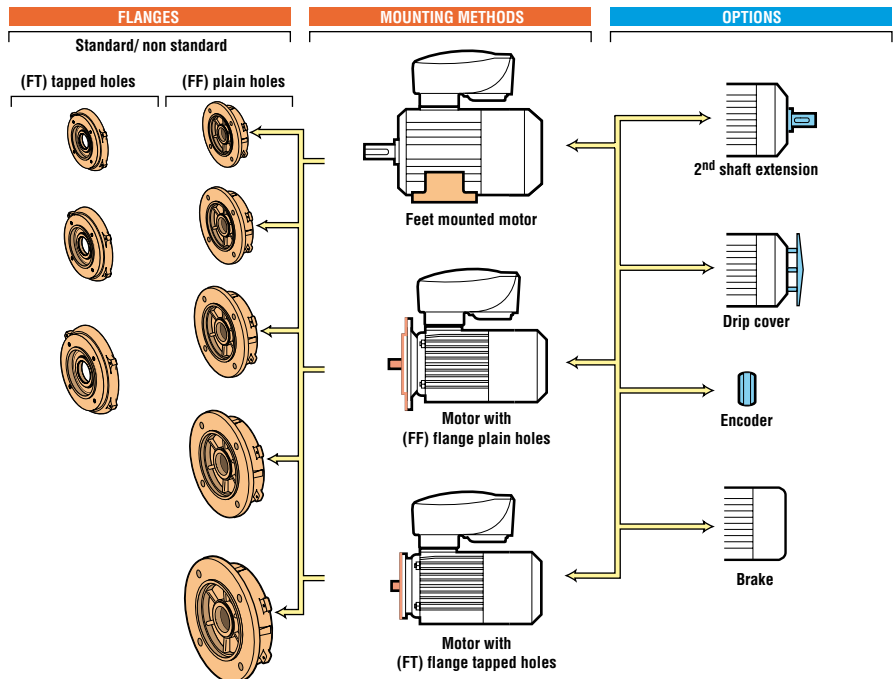

## Designation / Coding

<b>4P</b>	<b>LSES</b>	<b>90 L</b>	<b>1.5 kW</b>	<b>LS2 / IE2</b>	<b>VMA 32 150</b>	<b>BD</b>	<b>FLTVMA B</b>
No. of poles	Motor type	Frame size	Power in kW	Efficiency class	VARMECA rating	Button position and cable gland	Options

**Coding example:**

4P LSES 90 L 1.5 kW LS2/IE2 VMA 32 150 BD FLTVMA B

for Varmeca motor 4 power poles 1.5 kW with potentiometer to the right and CEM filter class B option

The chart below is an example.

It allows the building of the designation concerning the desired product.

This designation corresponds to a product code.

The product codes that are present in the selection grids can be used directly.







They facilitate the order handing over.

The coding table is incorporated in the price list with the list of designations.

# Variable speed motors VARMECA

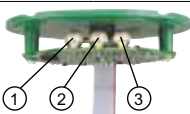







## Options designation

Designation	Remarks																																																												
 <p>B</p>	<p><b>Speed adjustment button option</b> The speed adjustment is done by graded button from 15 to 100 %.</p> <ul style="list-style-type: none"> <li>• 2 signalling indicators.</li> </ul>																																																												
 <p>BMA</p>	<p><b>Adjustment button option with integrated run/stop order</b> In addition to the speed adjustment, a run key and a stop one allow, once the VARMECA 30 is connected to voltage, to control it locally, willingly. In order to be taken into account, the run order needs a <b>second impulse</b> on the key.</p> <ul style="list-style-type: none"> <li>• 2 signalling indicators.</li> </ul>																																																												
 <p>BMAVAR</p>	<p><b>Adjustment button option with forward run/reverse run/stop</b> In addition to the speed adjustment, a forward run key, a reverse run key and a stop key allow, once the VARMECA 30 is connected to voltage to control it locally, willingly. In order to be taken into account, the run order needs a <b>second impulse</b> on the key.</p> <ul style="list-style-type: none"> <li>• 2 signalling indicators.</li> </ul>																																																												
 <p>CVIVMA</p>	<p><b>Internal speed adjustment option</b> The speed adjustments are done by accessible potentiometers after the lid is removed.</p> <ol style="list-style-type: none"> <li>① a potentiometer Mini. speed: minimal speed calibration,</li> <li>② a potentiometer Int. speed: speed adjustment that is substituted to the adjustment by button,</li> <li>③ a potentiometer Max. speed: maximal speed calibration.</li> </ol> <p>There are also 2 signalling indicators.</p>																																																												
 <p>FLT VMA 30</p>	<p><b>RFI filter option</b></p> <ul style="list-style-type: none"> <li>• FLT VMA / A: CEM filter = industrial level EN 51 000-6-2</li> <li>• FLT VMA / B: CEM filter = internal level EN 51 000-6-1 <ul style="list-style-type: none"> <li>- for VMA 31-32 M up to 1.1 kW inside and for 1.5 kW outside</li> <li>- for VMA 31-32 T up to 4 kW outside</li> <li>- for VMA 33-34 up to 11 kW inside</li> </ul> </li> </ul>																																																												
 <p>RF100 RF600 RF200 RF800</p>	<p><b>Braking resistor option</b> In order to operate in 4 quadrants and to dissipate the energy the resistors are directly fixed on the VARMECA box. Higher external resistors concerning thermic power can be used, in order to respect the minimal ohm value.</p> <table border="1"> <thead> <tr> <th rowspan="2"></th> <th colspan="3">RF 100</th> <th colspan="3">RF 200</th> <th colspan="3">RF 600</th> <th colspan="3">RF 800</th> </tr> <tr> <th>Peak power kW</th> <th>Thermic power kW</th> <th>Value Ω</th> <th>Peak power kW</th> <th>Thermic power kW</th> <th>Value Ω</th> <th>Peak power kW</th> <th>Thermic power kW</th> <th>Value Ω</th> <th>Peak power kW</th> <th>Thermic power kW</th> <th>Value Ω</th> </tr> </thead> <tbody> <tr> <td>VMA31T</td> <td>3.2</td> <td rowspan="4">0.1</td> <td rowspan="4">200</td> <td>3.2</td> <td rowspan="4">0.2</td> <td rowspan="4">200 (2x100 serial)</td> <td rowspan="4">-</td> <td rowspan="4">-</td> <td rowspan="4">-</td> <td>3.2</td> <td rowspan="4">0.8</td> <td rowspan="4">200</td> </tr> <tr> <td>VMA31M/TL</td> <td>0.8</td> <td>0.8</td> </tr> <tr> <td>VMA32T</td> <td>3.2</td> <td>3.2</td> </tr> <tr> <td>VMA32M/TL</td> <td>0.8</td> <td>0.8</td> </tr> <tr> <td>VMA33-34T/TL</td> <td>-</td> <td>-</td> <td>-</td> <td>-</td> <td>-</td> <td>-</td> <td>12.8</td> <td>0.6</td> <td>50</td> <td>-</td> <td>-</td> <td>-</td> </tr> </tbody> </table>		RF 100			RF 200			RF 600			RF 800			Peak power kW	Thermic power kW	Value Ω	Peak power kW	Thermic power kW	Value Ω	Peak power kW	Thermic power kW	Value Ω	Peak power kW	Thermic power kW	Value Ω	VMA31T	3.2	0.1	200	3.2	0.2	200 (2x100 serial)	-	-	-	3.2	0.8	200	VMA31M/TL	0.8	0.8	VMA32T	3.2	3.2	VMA32M/TL	0.8	0.8	VMA33-34T/TL	-	-	-	-	-	-	12.8	0.6	50	-	-	-
	RF 100			RF 200			RF 600			RF 800																																																			
	Peak power kW	Thermic power kW	Value Ω	Peak power kW	Thermic power kW	Value Ω	Peak power kW	Thermic power kW	Value Ω	Peak power kW	Thermic power kW	Value Ω																																																	
VMA31T	3.2	0.1	200	3.2	0.2	200 (2x100 serial)	-	-	-	3.2	0.8	200																																																	
VMA31M/TL	0.8			0.8																																																									
VMA32T	3.2			3.2																																																									
VMA32M/TL	0.8			0.8																																																									
VMA33-34T/TL	-	-	-	-	-	-	12.8	0.6	50	-	-	-																																																	
 <p>Shield 4 PE or 3 PE</p>	<p><b>4 PE or 3 PE (on request) shield option</b> A connection terminal on VARMECA allows the direct connection of a second brake motor.</p>																																																												
 <p>KEY PAD + 1 cord L=3 m</p>	<p><b>Parameter setting micro-console option</b> The micro-console option allows the access to the drive internal adjustments (terminal configuration, ramps adjustments, of the speeds, of the PI...).</p>																																																												

# Variable speed motors VARMECA



## Options designation

Designation VMA 31-32	Designation VMA 33-34	Remarks
	PA 200	<b>Digital display option for distance reading</b> Speed digital indicator Programmable indicator with speed scaling compared to speed image output: connection on the control terminal. • Supply: 10-70V DC
	PAD VMA	<b>Operating board option</b> VARMECA 30 operating board consists of a display, of three order keys and of 3 parameter setting keys. It cannot be mounted on the VMA 32M.
	SOFT VMA 30 + 1 cord L=3 m	<b>Parameter setting software option</b> This option allows the access to the drive internal adjustments starting with a PC. The software is compatible with WINDOWS 95, 98, NT, 2000, XP and subsequent versions.
-		<b>Encoder feedback option</b>
	VMA COM PB VMA COM IS VMA COM DT VMA COM CN	<b>Field bus option</b> The interface card is fixed on the inside of the box lid. Protocols: Profibus DP, InterBus S, DeviceNet, CAN open. It cannot be mounted on the VMA 32M.
	XPress Key	<b>Duplication key option (XPress Key)</b> The XPress Key option allows to safeguard a copy of the parameters group regarding VARMECA 30 in order to duplicate them very simply in another drive.
	POT 1T 10K - POT 10T 10K	<b>Potentiometer option</b> The speed adjustment can be obtained by: <ul style="list-style-type: none"> <li>- Potentiometer 1 round (ref. POT 1T 10K)</li> <li>• Specifications: 10 kΩ with button and protective cover: connection on the control terminal.</li> <li>- Potentiometer 10 rounds (ref. POT 10T 10K)</li> <li>• Specifications: 10 kΩ with button and indicator: connection on the control terminal.</li> </ul>
SO VMA 31/32	-	<b>Power supply and electromechanical brake control option</b> The motor must be fitted with an FCR brake (only on the VMA T in 400 V). The brake has a built-in power supply. The brake is released as soon as the run command is enabled. The brake is engaged after a stop command, at the end of the deceleration ramp or on disconnection of the power supply.
ESFR 31/32	ESFR 33/34	<b>Additional I/O interface and sequential brake control option</b> The brake has a built-in power supply. The brake is controlled according to a sequence which can be adjusted using the VARMECA parameters.

# Variable speed motors VARMECA



## Selection

**2**  
poles  
3000 min<sup>-1</sup>

**SINGLE-PHASE SUPPLY: from 200 V -10% to 240 V +10%, 50/60 Hz ±2%**  
**Three-phase motors 230/400V ±10% CONNECTED Δ**

Type	Rated moment at 3000 min <sup>-1</sup>	Measured moment (N.m)									Starting up moment	Switching frequency	IM B3 weight
	$M_N$ N.m	Speeds (min <sup>-1</sup> )									$M_D$ N.m	$F_D$ kHz	kg
		600	900	1200	1500	1800	2200	2400	3000	3600			
LS 71 L 0.25 kW - VMA 31M 025	0.8	0.7	0.7	0.7	0.7	0.8	0.8	0.8	1	0.7	1.6	4	10.6
LS 71 L 0.37 kW - VMA 31M 037	1.2	1.1	1.1	1.1	1.2	1.2	1.2	1.2	1.4	0.9	2.1	4	10.6
LS 71 L 0.55 kW - VMA 31M 055	1.8	1.5	1.5	1.6	1.7	1.8	1.8	1.8	1.8	1.4	2.7	4	11.5
LSES 80 L 0.75 kW - VMA 31M 075	2.4	2.1	2.1	2.3	2.4	2.5	2.7	2.7	2.6	2	4.5	4	13.7
LSES 80 L 1.1 kW - VMA 32M 110	3.5	3.3	3.3	3.5	3.5	3.5	3.8	3.8	3.8	2.9	8	4	14.9
LSES 90 S 1.5 kW - VMA 32M 150	4.8	4	4	4.3	4.3	4.3	4.5	4.5	4.8	4	9	4	17.2

**4**  
poles  
1500 min<sup>-1</sup>

**SINGLE-PHASE SUPPLY: from 200 V -10% to 240 V +10%, 50/60 Hz ±2%**  
**Three-phase motors 230/400V ±10% CONNECTED Δ**

Type	Rated moment at 1500 min <sup>-1</sup>	Measured moment (N.m)								Starting up moment	Switching frequency	IM B3 weight
	$M_N$ N.m	Speeds (min <sup>-1</sup> )								$M_D$ N.m	$F_D$ kHz	kg
		300	600	900	1200	1500	1800	2200				
LS 71 L 0.25 kW - VMA 31M 025	1.6	1.6	1.6	1.6	1.7	2.2	1.4	1.1	2.9	4	10.6	
LS 71 L 0.37 kW - VMA 31M 037	2.4	2.2	2.2	2.2	2.3	2.8	2	1.6	4	4	11.5	
LS 71 L 0.55 kW - VMA 31M 055	3.6	2.6	2.6	2.8	3.2	3.6	2.9	2	5.5	4	12.5	
LSES 80 LG 0.75 kW - VMA 31M 075	4.8	3	4	4.4	4.4	4.8	4	3	10	4	15.9	
LSES 80 LG 0.9 kW - VMA 32M 090	5.7	4	4.8	5.4	5.7	5.7	4.8	4	11	4	16.7	
LSES 90 S 1.1 kW - VMA 32M 110	7	4.7	5.3	6.7	7	7	5.8	4.4	13	4	18.4	
LSES 90 L 1.5 kW - VMA 32M 150	9.5	6.2	8.2	9.1	9.5	9.5	7.8	6.2	18	4	18.8	

**6**  
poles  
1000 min<sup>-1</sup>

**SINGLE-PHASE SUPPLY: from 200 V -10% to 240 V +10%, 50/60 Hz ±2%**  
**Three-phase motors 230/400V ±10% CONNECTED Δ**

Type	Rated moment at 1000 min <sup>-1</sup>	Measured moment (N.m)						Starting up moment	Switching frequency	IM B3 weight
	$M_N$ N.m	Speeds (min <sup>-1</sup> )						$M_D$ N.m	$F_D$ kHz	kg
		200	400	600	1000	1200	1500			
LS 71 L 0.25 kW - VMA 31M 025	2.4	2.2	2.4	2.4	2.4	2	1.7	8	4	12.6
LS 80 L 0.37 kW - VMA 31M 037	3.5	3.1	3.4	3.7	3.8	3.2	2.6	10	4	13.9
LS 80 L 0.55 kW - VMA 31M 055	5.3	4.3	4.9	5.3	5.3	4.8	4.3	13	4	15.2
LSES 90 S 0.75 kW - VMA 32M 075	7.2	6.8	6.8	7.2	7.6	6.3	4.8	16	4	18.2
LSES 90 L 1.1 kW - VMA 32M 110	10.5	7.7	7.7	8.7	10.5	8.7	6.7	20	4	20.8

# Variable speed motors VARMECA



## Selection

**2**  
poles  
3000 min<sup>-1</sup>

**THREE-PHASE SUPPLY: from 200 V -10% to 240 V +10%, 50/60 Hz ±2%**  
**Three-phase motors 230/400V ±10% CONNECTED Δ**

Type	Rated moment at 3000 min <sup>-1</sup>	Measured moment (N.m)									Starting up moment	Switching frequency	IM B3 weight
	$M_N$ N.m	Speeds (min <sup>-1</sup> )									$M_D$ N.m	$F_D$ kHz	kg
		600	900	1200	1500	1800	2200	2400	3000	3600			
LS 71 L 0.25 kW - VMA 31TL 025	0.8	0.6	0.6	0.7	0.7	0.8	0.8	0.8	0.8	0.7	1.6	4	10.2
LS 71 L 0.37 kW - VMA 31TL 037	1.2	0.8	1	1.1	1.2	1.2	1.2	1.2	1.2	1	1.9	4	10.6
LS 71 L 0.55 kW - VMA 31TL 055	1.8	1.2	1.4	1.6	1.7	1.8	1.8	1.8	1.8	1.5	3.6	4	11.5
LSES 80 L 0.75 kW - VMA 31TL 075	2.4	2.1	2.1	2.3	2.4	20.5	2.7	2.7	2.6	2	4.5	4	13.7
LSES 80 L 1.1 kW - VMA 32TL 110	3.5	3.3	3.3	3.5	3.5	3.5	3.8	3.8	3.8	2.9	8	4	14.9
LSES 90 S 1.5 kW - VMA 32TL 150	4.8	4	4	4.3	4.3	4.3	4.5	4.5	4.8	4	9	4	17.2
LSES 90 L 1.8 kW - VMA 32TL 180	5.7	5.5	5.5	5.8	5.8	6	6	6.2	6.2	4.8	9.7	4	18.7
LSES 90 L 2.2 kW - VMA 32TL 220	7	7	7	7.2	7.5	7.5	7.5	7.5	7.5	6	12	4	20.3
LSES 100 L 3 kW - VMA 33TL 300	9.5	7	9	9	10	10	10	10	10	8	15	4	30.3
LSES 112 MR 4 kW - VMA 33TL 400	12.7	11	12	13	13	13	13	13	13	11	21	4	34.6
LSES 132 S 5.5 kW - VMA 34TL 550	17.5	17.5	17.5	17.5	17.5	17.5	17.5	17.5	17.5	14.6	29	4	43.1
LSES 132 SU 7.5 kW - VMA 34TL 750	23.9	24	24	24	24	24	24	24	24	20	39	4	49.2

**4**  
poles  
1500 min<sup>-1</sup>

**THREE-PHASE SUPPLY: from 200 V -10% to 240 V +10%, 50/60 Hz ±2%**  
**Three-phase motors 230/400V ±10% CONNECTED Δ**

Type	Rated moment at 1500 min <sup>-1</sup>	Measured moment (N.m)							Starting up moment	Switching frequency	IM B3 weight
	$M_N$ N.m	Speeds (min <sup>-1</sup> )							$M_D$ N.m	$F_D$ kHz	kg
		300	600	900	1200	1500	1800	2200			
LS 71 L 0.25 kW - VMA 31TL 025	1.6	1.4	1.4	1.4	1.5	2.1	1.4	1.1	3.2	4	10.6
LS 71 L 0.37 kW - VMA 31TL 037	2.4	1.6	1.8	1.9	2.2	2.4	2	1.6	4.8	4	11.5
LS 71 L 0.55 kW - VMA 31TL 055	3.6	2.7	2.7	2.8	3.2	3.6	2.9	2.1	5.4	4	12.5
LSES 80 LG 0.75 kW - VMA 31TL 075	4.8	3.4	4.2	4.6	4.6	4.9	4.1	3.2	10	4	15.9
LSES 80 LG 0.9 kW - VMA 32TL 090	5.7	4.6	5	5.8	6	6	5	4.2	11	4	16.7
LSES 90 S 1.1 kW - VMA 32TL 110	7	5.2	5.5	7	7	7	6	4.7	13	4	18.4
LSES 90 L 1.5 kW - VMA 32TL 150	9.5	7	8.5	9.5	9.5	9.5	8	6.5	18	4	18.8
LSES 90 LU 1.8 kW - VMA 32TL 180	11.5	7.7	10	11	12	12	10	8	24	4	23.2
LSES 100 L 2.2 kW - VMA 32TL 220	14	9.4	12	13	13	14.5	12	9.5	26	4	25.5
LSES 100 LR 3 kW - VMA 33TL 300	19.1	13	16	19	19	19	16	13	30	4	33.8
LSES 112 MU 4 kW - VMA 33TL 400	25.5	18	20	20	25	25	22	17	38	4	43.1
LSES 132 SU 5.5 kW - VMA 34TL 550 <sup>1</sup>	35	35	35	35	35	35	29	24	52	4	50.1
LSES 132 M 7.5 kW - VMA 34TL 750 <sup>1</sup>	47.8	48	48	48	48	48	40	32	72	4	65.1

1. Compulsory forced ventilation

**6**  
poles  
1000 min<sup>-1</sup>

**THREE-PHASE SUPPLY: from 200 V -10% to 240 V +10%, 50/60 Hz ±2%**  
**Three-phase motors 230/400V ±10% CONNECTED Δ**

Type	Rated moment at 1000 min <sup>-1</sup>	Measured moment (N.m)						Starting up moment	Switching frequency	IM B3 weight
	$M_N$ N.m	Speeds (min <sup>-1</sup> )						$M_D$ N.m	$F_D$ kHz	kg
		200	400	600	1000	1200	1500			
LS 71 L 0.25 kW - VMA 31TL 025	2.4	1.7	1.7	1.7	2.1	1.7	1.3	4.2	4	12.6
LS 80 L 0.37 kW - VMA 31TL 037	3.5	3.2	3.5	3.9	4	3.3	2.7	10	4	13.9
LS 80 L 0.55 kW - VMA 31TL 055	5.3	4.5	5	5.5	5.5	5	4.5	13	4	15.2
LSES 90 S 0.75 kW - VMA 32TL 075	7.2	7	7	7.5	8	6.5	5	16	4	18.2
LSES 90 L 1.1 kW - VMA 32TL 110	10.5	8	8	9	11	9	7	20	4	20.8
LSES 100 L 1.5 kW - VMA 32TL 150	14.3	8	10	15	15	12	10	26	4	26.3
LSES 112 MG 2.2 kW - VMA 33TL 220	21	12	18	21	21	18	15	32	4	36
LSES 132 S 3 kW - VMA 33TL 300	28.6	21	24	29	29	21	16	44	4	46
LSES 132 M 4 kW - VMA 34TL 400 <sup>1</sup>	38.2	38	38	38	38	32	22.5	57	4	56
LSES 132 MU 5.5 kW - VMA 34TL 550 <sup>1</sup>	52.6	53	53	53	53	42	32	78	4	71

1. Compulsory forced ventilation



# Variable speed motors VARMECA



## Selection

THREE-PHASE SUPPLY: VMA 31/32/33/34: from 400 V -10% to 480 V +10%, 50/60 Hz ±2%  
Three-phase motors 230/400V ±10% CONNECTED Y

2  
poles  
3000 min<sup>-1</sup>

Type	Rated moment at 3000 min <sup>-1</sup>	Measured moment (N.m)									Starting up moment	Switching frequency	IM B3 weight
	$M_N$ N.m	Speeds (min <sup>-1</sup> )									$M_D$ N.m	$F_D$ kHz	kg
		600	900	1200	1500	1800	2200	2400	3000	3600			
LS 71 L 0.25 kW - VMA 31T 025	0.8	0.7	0.7	0.7	0.7	0.8	0.8	0.8	1	0.7	1.6	4	10.2
LS 71 L 0.37 kW - VMA 31T 037	1.2	1.1	1.1	1.1	1.2	1.2	1.2	1.2	1.5	0.9	2.4	4	10.6
LS 71 L 0.55 kW - VMA 31T 055	1.8	1.5	1.5	1.6	1.7	1.8	1.8	1.8	1.9	1.1	3.3	4	11.5
LSES 80 L 0.75 kW - VMA 31T 075	2.4	2.1	2.1	2.3	2.4	2.5	2.7	2.7	2.6	2	4.5	4	13.7
LSES 80 L 1.1 kW - VMA 31T 110	3.5	3.3	3.3	3.5	3.5	3.5	3.8	3.8	3.8	2.9	8	4	14.9
LSES 90 S 1.5 kW - VMA 32T 150	4.8	4	4	4.3	4.3	4.3	4.5	4.5	4.8	4	9	4	17.2
LSES 90 L 1.8 kW - VMA 32T 180	5.7	5.5	5.5	5.8	5.8	6	6	6.2	6.2	4.8	9.7	4	18.7
LSES 90 L 2.2 kW - VMA 32T 220	7	7	7	7.2	7.5	7.5	7.5	7.5	7.5	6	12	4	20.3
LSES 100 L 3 kW - VMA 32T 300	9.5	6.7	8.5	9	9.5	9	10	10	10	8	14	4	26.4
LSES 112 MR 4 kW - VMA 32T 400	12.7	11	12	13	13	13	13	13	13	10.7	19	4	30.7
LSES 132 S 5.5 kW - VMA 33T 550	17.5	14	15	15	15	15.8	16.8	18	18	14.6	29	4	43.1
LSES 132 SU 7.5 kW - VMA 33T 750	23.9	16.1	16.1	20	23.9	24.9	25.2	25.4	24.8	19.8	39	4	49.1
LSES 132 M 9 kW - VMA 34T 900	28.7	23	24	26	29	29	29	29	29	24	49	4	58.1
LSES 132 M 11 kW - VMA 34T 111	35	26	27	31	35	35	35	35	35	29	52	4	63.1

THREE-PHASE SUPPLY: VMA 31/32/33/34: from 400 V -10% to 480 V +10%, 50/60 Hz ±2%  
Three-phase motors 230/400V ±10% CONNECTED Y

4  
poles  
1500 min<sup>-1</sup>

Type	Rated moment at 1500 min <sup>-1</sup>	Measured moment (N.m)							Starting up moment	Switching frequency	IM B3 weight
	$M_N$ N.m	Speeds (min <sup>-1</sup> )							$M_D$ N.m	$F_D$ kHz	kg
		300	600	900	1200	1500	1800	2200			
LS 71 L 0.25 kW - VMA 31T 025	1.6	1.4	1.4	1.4	1.5	2.1	1.4	1.1	3.4	4	10.6
LS 71 L 0.37 kW - VMA 31T 037	2.4	2.1	2.1	2.1	2.2	2.8	2	1.6	4.2	4	11.5
LS 71 L 0.55 kW - VMA 31T 055	3.6	2.8	2.8	2.8	3.2	3.8	2.9	2.4	5.8	4	12.5
LSES 80 LG 0.75 kW - VMA 31T 075	4.8	3.4	4.2	4.6	4.6	4.9	4.1	3.2	10	4	15.9
LSES 80 LG 0.9 kW - VMA 31T 090	5.7	4.6	5	5.8	6	6	5	4.2	11	4	16.7
LSES 90 S 1.1 kW - VMA 31T 110	7	5.2	5.5	7	7	7	6	4.7	13	4	16.4
LSES 90 L 1.5 kW - VMA 32T 150	9.5	7	8.5	9.5	9.5	9.5	8	6.5	18	4	18.8
LSES 90 LU 1.8 kW - VMA 32T 180	11.5	7.7	10	11	12	12	10	8	24	4	23.2
LSES 100 L 2.2 kW - VMA 32T 220	14	9.4	12	13	13	14.5	12	9.5	26	4	25.5
LSES 100 LR 3 kW - VMA 32T 300	19.1	12.8	12	15	17	19.1	16	12.8	30	4	29.9
LSES 112 MU 4 kW - VMA 32T 400	25.5	18	20	20	25	25	22	17	40	4	43.1
LSES 132 SU 5.5 kW - VMA 33T 550	35	25	35	35	35	35	30	24	52	4	50.1
LSES 132 M 7.5 kW - VMA 33T 750	47.8	31.9	40	47	48	48	40	32	72	4	65.1
LSES 132 MU 9 kW - VMA 34T 900 <sup>1</sup>	57.3	58	58	58	58	58	48	39	85	4	76.1
LSES 160 MR 11 kW - VMA 34T 111 <sup>1</sup>	70	70	70	70	70	70	58	46	102	4	85.1

1. Compulsory forced ventilation

THREE-PHASE SUPPLY: VMA 31/32/33/34: from 400 V -10% to 480 V +10%, 50/60 Hz ±2%  
Three-phase motors 230/400V ±10% CONNECTED Y

6  
poles  
1000 min<sup>-1</sup>

Type	Rated moment at 1000 min <sup>-1</sup>	Measured moment (N.m)						Starting up moment	Switching frequency	IM B3 weight
	$M_N$ N.m	Speeds (min <sup>-1</sup> )						$M_D$ N.m	$F_D$ kHz	kg
		200	400	600	1000	1200	1500			
LS 71 L 0.25 kW - VMA 31T 025	2.4	1.6	1.6	1.7	2.2	1.8	1.4	4.6	4	12.6
LS 80 L 0.37 kW - VMA 31T 037	3.5	3.2	3.5	3.9	4	3.3	2.7	10	4	13.9
LS 80 L 0.55 kW - VMA 31T 055	5.3	4.5	5	5.5	5.5	5	4.5	13	4	15.2
LSES 90 S 0.75 kW - VMA 31T 075	7.2	7	7	7.5	8	6.5	5	16	4	18.2
LSES 90 L 1.1 kW - VMA 32T 110	10.5	8	8	9	11	9	7	20	4	20.8
LSES 100 L 1.5 kW - VMA 32T 150	14.3	8	10	15	15	12	10	30	4	26.3
LSES 112 MG 2.2 kW - VMA 32T 220	21	9	12	18	20	18	15	40	4	32
LSES 132 S 3 kW - VMA 32T 300	28.6	14	18	19	25	21	16	50	4	42
LSES 132 M 4 kW - VMA 33T 400	38.2	32	34	38	38	32	23	57	4	56
LSES 132 MU 5.5 kW - VMA 33T 550	52.6	47	53	53	53	42	32	78	4	71
LSES 160 M 7.5 kW - VMA 34T 750 <sup>1</sup>	71.7	72	72	72	72	60	48	108	4	90.1
LSES 160 LU 11 kW - VMA 34T 111 <sup>1</sup>	105	105	105	105	105	87	70	156	4	

1. Compulsory forced ventilation



# Variable speed motors VARMECA



## Dimensions

### Dimensions of the VARMECA motors

– shaft end

Dimensions in millimetres

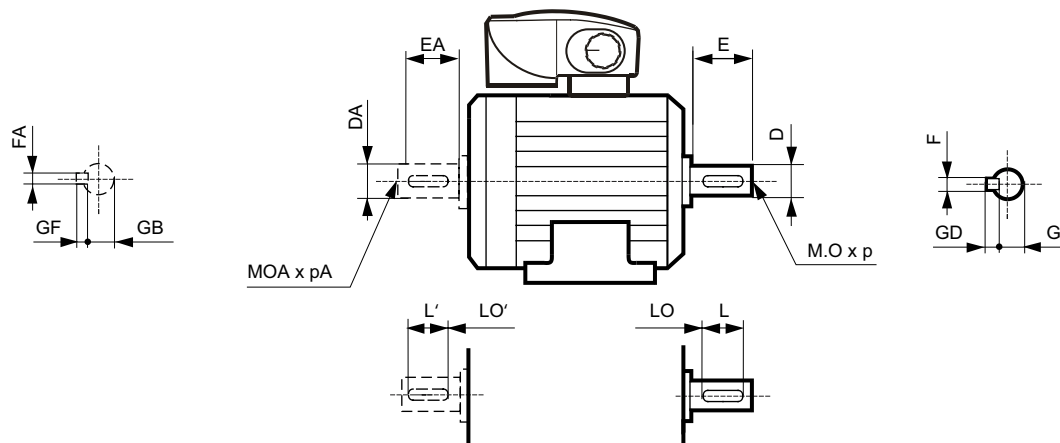

Type	Main shaft end																	
	4 and 6 poles									2 poles								
	F	GD	D	G	E	O	p	L	LO	F	GD	D	G	E	O	p	L	LO
LS 71L - VMA 31	5	5	14j6	11	30	5	15	25	3.5	5	5	14j6	5	30	5	15	25	3.5
LSES 80L/LG - VMA 31/32	6	6	19j6	15.5	40	6	16	30	6	6	6	19j6	15.5	40	6	16	30	6
LSES 90S/L - VMA 32/33	8	7	24j6	20	50	8	19	40	6	8	7	24j6	20	50	8	19	40	6
LSES 100L/LR - VMA 32/33	8	7	28j6	24	60	10	22	50	6	8	7	28j6	24	60	10	22	50	6
LSES 112MR/MG/MU - VMA 32/33	8	7	28j6	24	60	10	22	50	6	8	7	28j6	24	60	10	22	50	6
LSES 132S/SU/M/MU - VMA 33/34	10	8	38k6	33	80	12	28	63	10	10	8	38k6	33	80	12	28	63	10
LSES 160MP/MR/M/L/LU - VMA 33/34	12	8	42k6	37	110	16	36	100	6	12	8	42k6	37	110	16	36	100	6

Type	Secondary shaft end																	
	4 and 6 poles									2 poles								
	FA	GF	DA	GB	EA	OA	pA	L'	LO'	FA	GF	DA	GB	EA	OA	pA	L'	LO'
LSES 80L/LG - VMA 31/32	5	5	14j6	11	30	5	15	25	3.5	5	5	14j6	11	30	5	15	25	3.5
LSES 90S/L - VMA 32/33	6	6	19j6	15.5	40	6	16	30	6	6	6	19j6	15.5	40	6	16	30	6
LSES 100L/LR - VMA 32/33	8	7	24j6	20	50	8	19	40	6	8	7	24j6	20	50	8	19	40	6
LSES 112MR/MG/MU - VMA 32/33	8	7	24j6	20	50	8	19	40	6	8	7	24j6	20	50	8	19	40	6
LSES 132S/SU/M/MU - VMA 33/34	8	7	28k6	24	60	10	22	50	6	8	7	28k6	24	60	10	22	50	6
LSES 160MP/MR - VMA 33/34	12	8	38k6	37	80	16	36	100	6	12	8	38k6	37	80	16	36	100	6

# Variable speed motors VARMECA



## Dimensions

### Dimensions of the VARMECA motors

Dimensions in millimetres

– foot mounted

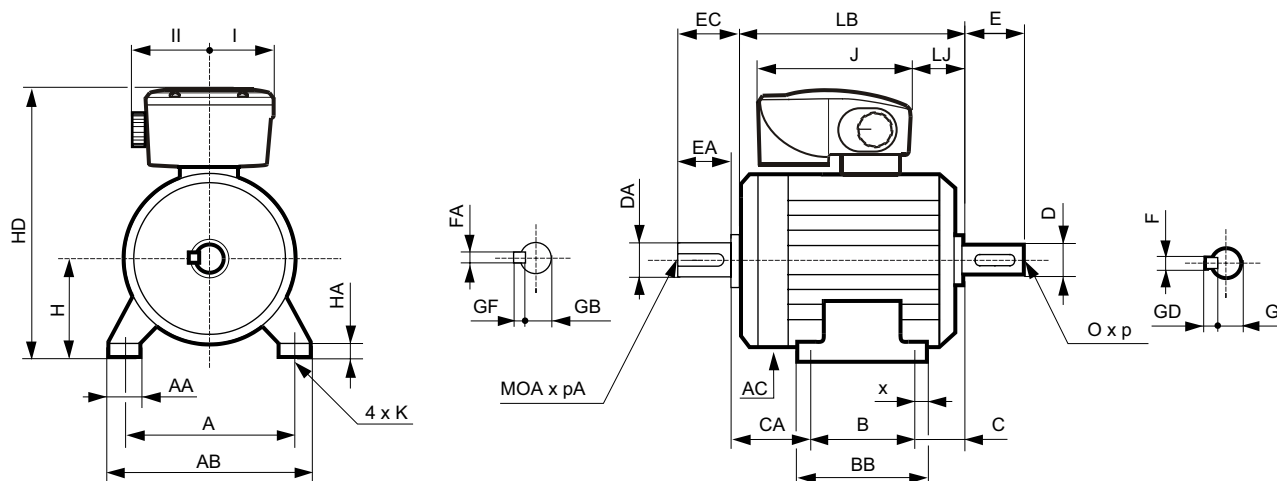

Type	Main dimensions																	
	A	AB	B	BB	C	x	AA	K	HA	H	AC*	HD	LB	LJ	J	I	II'	CA
LS 71L - VMA 31	112	126	90	106	45	7.5	24	7	9	71	140	247	193	10	217	75	88	61
LSES 80L - VMA 31	125	157	100	120	50	10	29	9	10	80	170	270	215	12	217	75	91	68
LSES 80L - VMA 32	125	157	100	120	50	10	29	9	10	80	170	270	215	12	231	75	91	68
LSES 80LG - VMA 31	125	157	100	125	50	14	31	9	10	80	185	280	247	12	217	75	91	99
LSES 80LG - VMA 32	125	157	100	125	50	14	31	9	10	80	185	280	247	12	231	75	91	99
LSES 90S - VMA 32	140	172	100	120	56	10	37	10	11	90	190	290	217.5	12	231	75	91	66
LSES 90L - VMA 32	140	172	125	162	56	28	39	10	11	90	190	290	244.5	12	231	75	91	68
LSES 100L - VMA 32	160	196	140	165	63	12	40	12	13	100	200	305	290	12	231	75	91	93
LSES 100L - VMA 33	160	196	140	165	63	12	40	12	13	100	200	370	290	4	336	115	141	93
LSES 100LR - VMA 33	160	196	140	165	63	12	40	12	13	100	200	305	309	12	231	75	91	111
LSES 100LR - VMA 33	160	196	140	165	63	12	40	12	13	100	200	370	309	4	336	115	141	111
LSES 112MR - VMA 32	190	220	140	165	69	13	45	12	14	112	200	316	309	12	231	75	91	104
LSES 112MR - VMA 33	190	220	140	165	69	13	45	12	14	112	200	382	309	4	336	115	141	104
LSES 112MU - VMA 32	190	220	140	165	70	12	52	12	14	112	235	325	333	21	231	75	91	130
LSES 112MU - VMA 33	190	220	140	165	70	12	52	12	14	112	235	392	333	13	336	115	141	130
LSES 112MG - VMA 32	190	220	140	165	70	12	52	12	14	112	235	325	315	21	231	75	91	110
LSES 112MG - VMA 33	190	220	140	165	70	12	52	12	14	112	235	392	315	13	336	115	141	110
LSES 132S - VMA 33/34	216	250	140	170	89	16	42	12	16	132	220	411	350	30	336	115	141	128
LSES 132SU - VMA 33/34	216	250	140	170	89	16	42	12	16	132	220	411	377	30	336	115	141	152
LSES 132M - VMA 33/34	216	250	178	208	89	15	50	12	15	132	265	432	385	8	336	115	141	126
LSES 132MU - VMA 33/34	216	250	178	208	89	15	50	12	15	132	265	432	412	8	336	115	141	148
LSES 160MP - VMA 33/34	254	294	210	294	108	20	64	14	25	160	264	469	468	38	336	115	141	154
LSES 160MR - VMA 33/34	254	294	210	294	108	20	64	14	25	160	264	469	495	38	336	115	141	138

1. The II size consists of the order button: in order to deliver without button, take size I  
\* AC: housing diameter without lifting rings

# Variable speed motors VARMECA



## Dimensions

### Dimensions of the VARMECA motors

Dimensions in millimetres

– (FF) plain hole flange mounted

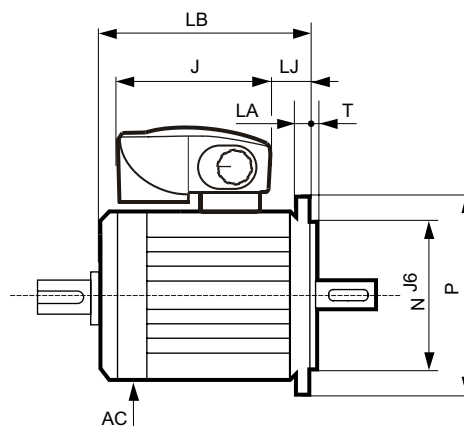
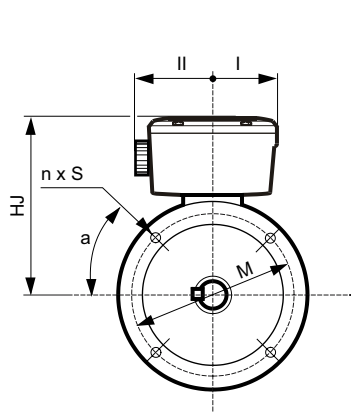

Type	Main dimensions						
	AC*	LB	HJ	LJ	J	I	II'
LS 71 - VMA 31	140	193	176	10	217	75	88
LSES 80L - VMA 31	170	215	190	12	217	75	91
LSES 80L - VMA 32	170	215	190	12	231	75	91
LSES 80LG - VMA 31	185	267	200	32	217	75	91
LSES 80LG - VMA 32	185	267	200	32	231	75	91
LSES 90S - VMA 32	190	237	200	32	231	75	91
LSES 90L - VMA 32	190	265	200	32	231	75	91
LSES 100L - VMA 32	200	290	205	12	231	75	91
LSES 100L - VMA 33	200	290	270	4	336	115	141
LSES 100LR - VMA 33	200	309	205	12	231	75	91
LSES 100LR - VMA 33	200	309	270	4	336	115	141
LSES 112MR - VMA 32	200	309	204	12	231	75	91
LSES 112MR - VMA 33	200	309	270	4	336	115	141
LSES 112MU - VMA 32	235	333	213	21	231	75	91
LSES 112MU - VMA 33	235	333	280	13	336	115	141
LSES 112MG - VMA 32	235	315	213	21	231	75	91
LSES 112MG - VMA 33	235	315	280	13	336	115	141
LSES 132S - VMA 33/34	220	350	279	30	336	115	141
LSES 132SU - VMA 33/34	220	377	279	30	336	115	141
LSES 132M - VMA 33/34	265	385	300	8	336	115	141
LSES 132MU - VMA 33/34	265	412	300	8	336	115	141
LSES 160MP - VMA 33/34	264	468	309	38	336	115	141
LSES 160MR - VMA 33/34	264	495	309	38	336	115	141

1. The II size consists of the order button: in order to deliver without button, take size I  
\* AC: housing diameter without lifting rings

Type	IEC symbol	Flange dimensions (FF)							
		M	N	P	T	n	a	S	LA
LS 71	FF 130	130	110	160	3.5	4	45°	10	10
LSES 80L/LG	FF 165	165	130	200	3.5	4	45°	12	10
LSES 90S/L	FF 165	165	130	200	3.5	4	45°	12	10
LSES 100L/LR	FF 215	215	180	250	4	4	45°	15	12
LSES 112MG/MR/MU	FF 215	215	180	250	4	4	45°	15	12
LSES 132S/M/SU/MU	FF 265	265	230	300	4	4	45°	15	14
LSES 160MP/MR	FF 300	300	250	350	5	4	45°	18.5	14

CA dimension and shaft end dimensions identical to those of the foot mounted motors.

# Variable speed motors VARMECA



## Dimensions

### Dimensions of the VARMECA motors

Dimensions in millimetres

– (FT) tapped hole flange mounted

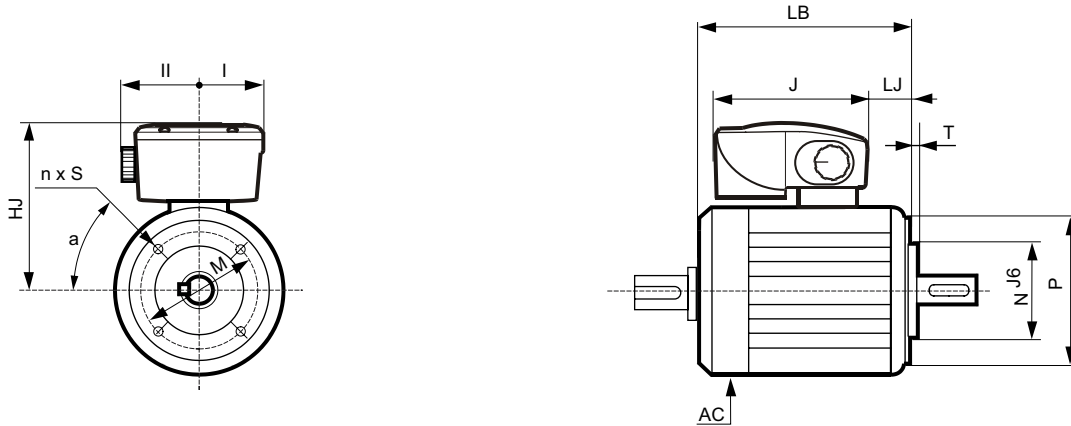

Type	Main dimensions						
	AC*	LB	HJ	LJ	J	I	II'
LS 71 - VMA 31	140	193	176	10	217	75	88
LSES 80L - VMA 31	170	215	190	12	217	75	91
LSES 80L - VMA 32	170	215	190	12	231	75	91
LSES 80LG - VMA 31	185	247	200	12	217	75	91
LSES 80LG - VMA 32	185	247	200	12	231	75	91
LSES 90S - VMA 32	190	217.5	200	12	231	75	91
LSES 90L - VMA 32	190	244.5	200	12	231	75	91
LSES 100L - VMA 32	200	290	205	12	231	75	91
LSES 100L - VMA 33	200	290	270	4	336	115	141
LSES 100LR - VMA 33	200	309	205	12	231	75	91
LSES 100LR - VMA 33	200	309	270	4	336	115	141
LSES 112MR - VMA 32	200	309	204	12	231	75	91
LSES 112MR - VMA 33	200	309	270	4	336	115	141
LSES 112MU - VMA 32	235	333	213	21	231	75	91
LSES 112MU - VMA 33	235	333	280	13	336	115	141
LSES 112MG - VMA 32	235	315	213	21	231	75	91
LSES 112MG - VMA 33	235	315	280	13	336	115	141
LSES 132S - VMA 33/34	220	350	279	30	336	115	141
LSES 132SU - VMA 33/34	220	377	279	30	336	115	141
LSES 132M - VMA 33/34	265	385	300	8	336	115	141
LSES 132MU - VMA 33/34	265	412	300	8	336	115	141
LSES 160MP - VMA 33/34	264	468	309	38	336	115	141
LSES 160MR - VMA 33/34	264	495	309	38	336	115	141

1. The II size consists of the order button: in order to deliver without button, take size I  
\* AC: housing diameter without lifting rings







Type	IEC symbol	Flange dimensions (FT)						
		M	N	P	T	n	a	S
LS 71	FT 85	85	70	105	2.5	4	45°	M6
LSES 80L	FT 100	100	80	120	3	4	45°	M6
LSES 90S/L	FT 115	115	95	140	3	4	45°	M8
LSES 100L/LR	FT 130	130	110	160	3.5	4	45°	M8
LSES 112MG/MR/MU	FT 130	130	110	160	3.5	4	45°	M8
LSES 132S/M/SU/MU	FT 215	215	180	250	4	4	45°	M12
LSES 160MP/MR	FT 265	265	230	300	4	4	45°	M12

CA dimension and shaft end dimensions identical to those of the foot mounted motors.

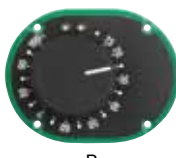
# Variable speed motors VARMECA

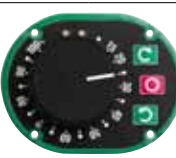
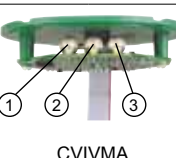

## Lead times of the options

Designation	Reference	Code	
 B	B 31/32	4429850	
	B 33/34	4277672	
 BMA	BMA 31/32	4429849	
	BMA 33/34	4277673	
 BMAVAR	BMA VAR 31/32	4429851	
	BMA VAR 33/34	4277674	
 CVIVMA	CVI VAR 31/32	4429852	
	CVI VAR 33/34	4277671	
 FLT VMA 30	VMA 31 M/ML	<b>FLT VMA / A</b> 4487962	
	VMA 32 M	enclosed into standard box	
	VMA 31-32 T/TL	4488646	
	VMA 33-34 TL	4625112	
	VMA 33-34 T	4277677	not available
		4277678	not available
 RF100 RF600 RF200 RF800	RF 100	4017379	
	RF 200	4017380	
	RF 600	4285090	
	RF 800	4501800	
 4 PE or 3 PE shield	4 PE shield	4040129	
	3 PE shield	4228506	
 KEY PAD + 1 cord L=3 m	KEY PAD LCD	4438305	

DG < 2 WD < 5 WD < To agree

DG: Availability ; n WD: Working Days (at the departure of the factory).

# Variable speed motors VARMECA



## Lead times of the options

Designation VMA 31-32	Designation VMA 33-34	Reference	Code
 PA 200	PA 200	PA 200	4191124
 PAD VMA		PAD VMA 31/32	4425477
		PAD VMA 33/34	4426436
 SOFT VMA 30 + 1 cord L=3 m		cable CTCOMMS (SUBD plug)	4238391
		cable USB CONVERTER (USB plug)	4433998
-	 COD VMA30	COD VMA	4285091
 VMA COM PB	VMA COM PB VMA COM IS VMA COM DT VMA COM CN	<b>VMA 33/34</b>	
		VMA COM PB	4349222
		VMA COM IS	4238388
		VMA COM DT	4238387
		VMA COM CN	4349225
 XPress Key		PX KEY 30	4277675
 POT 1T 10K - POT 10T 10K		POT 1T 10K	3629849
		POT 10T 10K	3629851
SO VMA 31/32	-	SOVMA	4470636
ESFR 31/32	ESFR 33/34	ESFR 31/32	4469505
		ESFR 33/34	4320865

DG < 2 WD < 5 WD < To agree

DG: Availability ; n WD: Working Days (at the departure of the factory).

# Variable speed motors VARMECA



## Lead times

**2**  
poles  
3000 min<sup>-1</sup>

**SINGLE-PHASE SUPPLY: from 200 V -10% to 240 V +10%, 50/60 Hz ±2%**  
**Three-phase motors 230/400V ±10% CONNECTED Δ**

Type	Rated power at 50 Hz $P_N$ kW	IM 1001 <sup>1</sup> (IM B3)		IM 3001 <sup>1</sup> (IM B5)		IM 2001 <sup>1</sup> (IM B35)		IM 3601 <sup>1</sup> (IM B14)		IM 2101 <sup>1</sup> (IM B34)	
		Code	Qty	Code	Qty	Code	Qty	Code	Qty	Code	Qty
LS 71 L - VMA A31M 025 SD <sup>2</sup>	0.25	4470467	2	4470469	2		-	4470471	2		-
LS 71 L - VMA A31M 037 SD <sup>2</sup>	0.37	4470472	2	4470473	2		-	4470475	2		-
LS 71 L - VMA A31M 055 SD <sup>2</sup>	0.55	4470484	2	4470481	2		-	4470479	2		-
LSES 80 L - VMA A31M 075 SD <sup>2</sup>	0.75	4774909	2	4783492	2	4792365	2	4787502	2	4792367	2
LSES 80 L - VMA A32M 110 SD <sup>2</sup>	1.1	4787500	2	4782355	2	4792370	2	4787503	2	4792373	2
LSES 90 S - VMA A32M 150 SD <sup>2</sup>	1.5	4767081	2	4787501	2	4792375	2	4787504	2	4792376	2

1. Motors IM B5 / IM V1 - IM B35 / IM V5 - IM B14 / IM V18 - IM B34 / IM V58  
2. Without button - Cable gland to the right.

**4**  
poles  
1500 min<sup>-1</sup>

**SINGLE-PHASE SUPPLY: from 200 V -10% to 240 V +10%, 50/60 Hz ±2%**  
**Three-phase motors 230/400V ±10% CONNECTED Δ**

Type	Rated power at 50 Hz $P_N$ kW	IM 1001 <sup>1</sup> (IM B3)		IM 3001 <sup>1</sup> (IM B5)		IM 2001 <sup>1</sup> (IM B35)		IM 3601 <sup>1</sup> (IM B14)		IM 2101 <sup>1</sup> (IM B34)	
		Code	Qty	Code	Qty	Code	Qty	Code	Qty	Code	Qty
LS 71 L - VMA A31M 025 SD <sup>2</sup>	0.25	4470455	2	4470456	2		-	4470457	2		-
LS 71 L - VMA A31M 037 SD <sup>2</sup>	0.37	4470458	2	4470459	2		-	4463553	2		-
LS 71 L - VMA A31M 055 SD <sup>2</sup>	0.55	4470462	2	4454959	2		-	4470466	2		-
LSES 80 LG - VMA A31M 075 SD <sup>2</sup>	0.75	4779722	2	4787507	2	4792381	2	4787509	2	4792382	2
LSES 80 LG - VMA A32M 090 SD <sup>2</sup>	0.9	4787505	2	4787508	2	4792384	2	4787510	2	4792385	2
LSES 90 S - VMA A32M 110 SD <sup>2</sup>	1.1	4787506	2	4779899	2	4792387	2	4787511	2	4784532	2
LSES 90 L - VMA A32M 150 SD <sup>2</sup>	1.5	4767094	2	4777172	2	4792389	2	4787512	2	4780242	2

1. Motors IM B5 / IM V1 - IM B35 / IM V5 - IM B14 / IM V18 - IM B34 / IM V58  
2. Without button - Cable gland to the right.

**6**  
poles  
1000 min<sup>-1</sup>

**SINGLE-PHASE SUPPLY: from 200 V -10% to 240 V +10%, 50/60 Hz ±2%**  
**Three-phase motors 230/400V ±10% CONNECTED Δ**

Type	Rated power at 50 Hz $P_N$ kW	IM 1001 <sup>1</sup> (IM B3)		IM 3001 <sup>1</sup> (IM B5)		IM 2001 <sup>1</sup> (IM B35)		IM 3601 <sup>1</sup> (IM B14)		IM 2101 <sup>1</sup> (IM B34)	
		Code	Qty	Code	Qty	Code	Qty	Code	Qty	Code	Qty
LS 71 L - VMA A31M 025 SD <sup>2</sup>	0.25	4514655	2	4521148	2		-	4521150	2		-
LS 80 L - VMA A31M 037 SD <sup>2</sup>	0.37	4472274	2	4472298	2		-	4472301	2		-
LS 80 L - VMA A31M 055 SD <sup>2</sup>	0.55	4472311	2	4472315	2		-	4472320	2		-
LSES 90 S - VMA A32M 075 SD <sup>2</sup>	0.75	4787513	2	4787515	2	4792392	2	4787517	2	4792393	2
LSES 90 L - VMA A32M 110 SD <sup>2</sup>	1.1	4787514	2	4787516	2	4792396	2	4787518	2	4792397	2

1. Motors IM B5 / IM V1 - IM B35 / IM V5 - IM B14 / IM V18 - IM B34 / IM V58  
2. Without button - Cable gland to the right.

DG < 2 WD < 5 WD < To agree

DG: Availability ; n WD: Working Days (at the departure of the factory).



# Variable speed motors VARMECA



## Lead times

**2**  
poles  
3000 min<sup>-1</sup>

**THREE-PHASE SUPPLY: from 200 V -10% to 240 V +10%, 50/60 Hz ±2%**  
**Three-phase motors 230/400V ±10% CONNECTED Δ**

Type	Rated power at 50 Hz $P_N$ kW	IM 1001 <sup>1</sup> (IM B3)		IM 3001 <sup>1</sup> (IM B5)		IM 2001 <sup>1</sup> (IM B35)		IM 3601 <sup>1</sup> (IM B14)		IM 2101 <sup>1</sup> (IM B34)	
		Code	Qty	Code	Qty	Code	Qty	Code	Qty	Code	Qty
LS 71 L - VMA A31TL 025 SD <sup>2</sup>	0.25	4551856	2	4551858	2		-	4551860	2		-
LS 71 L - VMA A31TL 037 SD <sup>2</sup>	0.37	4498688	2	4498689	2		-	4498690	2		-
LS 71 L - VMA A31TL 055 SD <sup>2</sup>	0.55	4498685	2	4498686	2		-	4498687	2		-
LSES 80 L - VMA A31TL 075 SD <sup>2</sup>	0.75	4787519	2	4787525	2	4792750	2	4787532	2	4792758	2
LSES 80 L - VMA A32TL 110 SD <sup>2</sup>	1.1	4787520	2	4787526	2	4792752	2	4787533	2	4792759	2
LSES 90 S - VMA A32TL 150 SD <sup>2</sup>	1.5	4787521	2	4787527	2	4792753	2	4787534	2	4792761	2
LSES 90 L - VMA A32TL 180 SD <sup>2</sup>	1.8	4787522	2	4787528	2	4792754	2	4787535	2	4792762	2
LSES 90 L - VMA A32TL 220 SD <sup>2</sup>	2.2	4777694	2	4787529	2	4792755	2	4787536	2	4792763	2
LSES 100 L - VMA A33TL 300 SD <sup>2</sup>	3	4787523	2	4787530	2	4792756	2	4787537	2	4792764	2
LSES 112 MR - VMA A33TL 400 SD <sup>2</sup>	4	4787524	2	4787531	2	4792757	2	4787538	2	4792765	2
LSES 132 S - VMA A34TL 550 SD <sup>2</sup>	5.5	4787638	1	4787642	1	4801070	1	4787640	1	4801072	1
LSES 132 SU - VMA A34TL 750 SD <sup>2</sup>	7.5	4787641	1	4787639	1	4801073	1	4787643	1	4801075	1

1. Motors IM B5 / IM V1 - IM B35 / IM V5 - IM B14 / IM V18 - IM B34 / IM V58 2. Without button - Cable gland to the right.

**4**  
poles  
1500 min<sup>-1</sup>

**THREE-PHASE SUPPLY: from 200 V -10% to 240 V +10%, 50/60 Hz ±2%**  
**Three-phase motors 230/400V ±10% CONNECTED Δ**

Type	Rated power at 50 Hz $P_N$ kW	IM 1001 <sup>1</sup> (IM B3)		IM 3001 <sup>1</sup> (IM B5)		IM 2001 <sup>1</sup> (IM B35)		IM 3601 <sup>1</sup> (IM B14)		IM 2101 <sup>1</sup> (IM B34)	
		Code	Qty	Code	Qty	Code	Qty	Code	Qty	Code	Qty
LS 71 L - VMA A31TL 025 SD <sup>2</sup>	0.25	4551853	2	4524519	2		-	4533362	2		-
LS 71 L - VMA A31TL 037 SD <sup>2</sup>	0.37	4498783	2	4498785	2		-	4498786	2		-
LS 71 L - VMA A31TL 055 SD <sup>2</sup>	0.55	4498793	2	4498795	2		-	4498797	2		-
LSES 80 LG - VMA A31TL 075 SD <sup>2</sup>	0.75	4787539	2	4753037	2	4792766	2	4753029	2	4792778	2
LSES 80 LG - VMA A32TL 090 SD <sup>2</sup>	0.9	4787540	2	4787546	2	4792767	2	4787552	2	4792780	2
LSES 90 S - VMA A32TL 110 SD <sup>2</sup>	1.1	4787541	2	4787547	2	4792768	2	4787553	2	4792782	2
LSES 90 L - VMA A32TL 150 SD <sup>2</sup>	1.5	4753084	2	4753087	2	4792769	2	4787554	2	4792783	2
LSES 90 LU - VMA A32TL 180 SD <sup>2</sup>	1.8	4787542	2	4787548	2	4792770	2	4787555	2	4792786	2
LSES 100 L - VMA A32TL 220 SD <sup>2</sup>	2.2	4787543	2	4787549	2	4792771	2	4787556	2	4792787	2
LSES 100 LR - VMA A33TL 300 SD <sup>2</sup>	3	4787544	2	4787550	2	4792772	2	4787557	2	4792788	2
LSES 112 MU - VMA A33TL 400 SD <sup>2</sup>	4	4787545	2	4787551	2	4792789	2	4787558	2	4792775	2
LSES 132 SU - VMA A34TL 550 SD <sup>2</sup>	5.5	4787644	1	4787648	1	4801076	1	4787646	1	4801079	1
LSES 132 M - VMA A34TL 750 SD <sup>2</sup>	7.5	4787647	1	4787645	1	4801081	1	4787649	1	4801077	1

1. Motors IM B5 / IM V1 - IM B35 / IM V5 - IM B14 / IM V18 - IM B34 / IM V58 2. Without button - Cable gland to the right.

**6**  
poles  
1000 min<sup>-1</sup>

**THREE-PHASE SUPPLY: from 200 V -10% to 240 V +10%, 50/60 Hz ±2%**  
**Three-phase motors 230/400V ±10% CONNECTED Δ**

Type	Rated power at 50 Hz $P_N$ kW	IM 1001 <sup>1</sup> (IM B3)		IM 3001 <sup>1</sup> (IM B5)		IM 2001 <sup>1</sup> (IM B35)		IM 3601 <sup>1</sup> (IM B14)		IM 2101 <sup>1</sup> (IM B34)	
		Code	Qty	Code	Qty	Code	Qty	Code	Qty	Code	Qty
LS 71 L - VMA A31TL 025 SD <sup>2</sup>	0.25	4498737	2	4498738	2		-	4498739	2		-
LS 80 L - VMA A31TL 037 SD <sup>2</sup>	0.37	4472198	2	4472199	2		-	4472195	2		-
LS 80 L - VMA A31TL 055 SD <sup>2</sup>	0.55	4472205	2	4472209	2		-	4472211	2		-
LSES 90 S - VMA A32TL 075 SD <sup>2</sup>	0.75	4787559	2	4787564	2	4792790	2	4787569	2	4792798	2
LSES 90 L - VMA A32TL 110 SD <sup>2</sup>	1.1	4787560	2	4787565	2	4792792	2	4787570	2	4792799	2
LSES 100 L - VMA A32TL 150 SD <sup>2</sup>	1.5	4787561	2	4787566	2	4792793	2	4787571	2	4792801	2
LSES 112 MG - VMA A33TL 220 SD <sup>2</sup>	2.2	4787562	2	4787567	2	4792794	2	4787572	2	4792802	2
LSES 132 S - VMA A33TL 300 SD <sup>2</sup>	3	4787563	1	4787568	1	4792795	1	4787573	1	4792805	1
LSES 132 M - VMA A34TL 400 SD <sup>2</sup>	4	4787650	1	4787654	1	4801082	1	4787652	1	4801084	1
LSES 132 MU - VMA A34TL 550 SD <sup>2</sup>	5.5	4787653	1	4787651	1	4801085	1	4787655	1	4801086	1

1. Motors IM B5 / IM V1 - IM B35 / IM V5 - IM B14 / IM V18 - IM B34 / IM V58 2. Without button - Cable gland to the right.

DG < 2 WD < 5 WD < To agree

DG: Availability ; n WD: Working Days (at the departure of the factory).

# Variable speed motors VARMECA



## Lead times

**2**  
poles  
3000 min<sup>-1</sup>

**THREE-PHASE SUPPLY: VMA 31/32/33/34: from 400 V -10% to 480 V +10%, 50/60 Hz ±2%**  
**Three-phase motors 230/400V ±10% CONNECTED Y**

Type	Rated power at 50 Hz $P_N$ kW	IM 1001 <sup>1</sup> (IM B3)		IM 3001 <sup>1</sup> (IM B5)		IM 2001 <sup>1</sup> (IM B35)		IM 3601 <sup>1</sup> (IM B14)		IM 2101 <sup>1</sup> (IM B34)	
		Code	Qty	Code	Qty	Code	Qty	Code	Qty	Code	Qty
LS 71 L - VMA A31T 025 SD <sup>2</sup>	0.25	4470536	2	4470537	2	-	-	4470539	2	-	-
LS 71 L - VMA A31T 037 SD <sup>2</sup>	0.37	4470540	2	4470541	2	-	-	4470542	2	-	-
LS 71 L - VMA A31T 055 SD <sup>2</sup>	0.55	4470543	2	4470544	2	-	-	4470545	2	-	-
LSES 80 L - VMA A31T 075 SD <sup>2</sup>	0.75	4787574	2	4766096	2	4792515	2	4787588	2	4792518	2
LSES 80 L - VMA A31T 110 SD <sup>2</sup>	1.1	4767118	2	4773562	2	4792517	2	4787589	2	4792519	2
LSES 90 S - VMA A32T 150 SD <sup>2</sup>	1.5	4781055	2	4787580	2	4792563	2	4787590	2	4792566	2
LSES 90 L - VMA A32T 180 SD <sup>2</sup>	1.8	4787575	2	4787581	2	4792567	2	4787591	2	4792568	2
LSES 90 L - VMA A32T 220 SD <sup>2</sup>	2.2	4787576	2	4787582	2	4792571	2	4787592	2	4792572	2
LSES 100 L - VMA A32T 300 SD <sup>2</sup>	3	4787577	2	4787583	2	4792574	2	4787593	2	4766529	2
LSES 112 MR - VMA A32T 400 SD <sup>2</sup>	4	4775467	2	4787584	2	4792575	2	4787594	2	4792576	2
LSES 132 S - VMA A33T 550 SD <sup>2</sup>	5.5	4787578	1	4773623	1	4792577	1	4787595	1	4792581	1
LSES 132 SU - VMA A33T 750 SD <sup>2</sup>	7.5	4775464	1	4787585	1	4792582	1	4787596	1	4792583	1
LSES 132 M - VMA A34T 900 SD <sup>2</sup>	9	4787579	1	4787586	1	4792612	1	4787597	1	4792614	1
LSES 132 M - VMA 34T 111 SD <sup>2</sup>	11	4775460	1	4787587	1	4792613	1	4787598	1	4792615	1

1. Motors IM B5 / IM V1 - IM B35 / IM V5 - IM B14 / IM V18 - IM B34 / IM V58 2. Without button - Cable gland to the right.

**4**  
poles  
1500 min<sup>-1</sup>

**THREE-PHASE SUPPLY: VMA 31/32/33/34: from 400 V -10% to 480 V +10%, 50/60 Hz ±2%**  
**Three-phase motors 230/400V ±10% CONNECTED Y**

Type	Rated power at 50 Hz $P_N$ kW	IM 1001 <sup>1</sup> (IM B3)		IM 3001 <sup>1</sup> (IM B5)		IM 2001 <sup>1</sup> (IM B35)		IM 3601 <sup>1</sup> (IM B14)		IM 2101 <sup>1</sup> (IM B34)	
		Code	Qty	Code	Qty	Code	Qty	Code	Qty	Code	Qty
LS 71 L - VMA A31T 025 SD <sup>2</sup>	0.25	4470526	2	4470527	2	-	-	4470529	2	-	-
LS 71 L - VMA A31T 037 SD <sup>2</sup>	0.37	4470530	2	4458810	2	-	-	4470532	2	-	-
LS 71 L - VMA A31T 055 SD <sup>2</sup>	0.55	4470533	2	4470534	2	-	-	4470535	2	-	-
LSES 80 LG - VMA A31T 075 SD <sup>2</sup>	0.75	4753044	2	4753053	2	4792524	2	4756399	2	4792540	2
LSES 80 LG - VMA A31T 090 SD <sup>2</sup>	0.9	4787599	2	4787603	2	4792537	2	4786254	2	4792541	2
LSES 90 S - VMA A31T 110 SD <sup>2</sup>	1.1	4787600	2	4766008	2	4792538	2	4753079	2	4792542	2
LSES 90 L - VMA A32T 150 SD <sup>2</sup>	1.5	4779400	2	4753068	2	4792616	2	4787609	2	4792626	2
LSES 90 LU - VMA A32T 180 SD <sup>2</sup>	1.8	4787601	2	4787604	2	4792618	2	4787610	2	4792628	2
LSES 100 L - VMA A32T 220 SD <sup>2</sup>	2.2	4752975	2	4763662	2	4792619	2	4767272	2	4792630	2
LSES 100 LR - VMA A32T 300 SD <sup>2</sup>	3	4777316	2	4787605	2	4792620	2	4787611	2	4792631	2
LSES 112 MU - VMA A32T 400 SD <sup>2</sup>	4	4775694	2	4787606	2	4792621	2	4787612	2	4792634	2
LSES 132 SU - VMA A33T 550 SD <sup>2</sup>	5.5	4773584	1	4785856	1	4782897	1	4787613	1	4792635	1
LSES 132 M - VMA A33T 750 SD <sup>2</sup>	7.5	4777604	1	4787607	1	4783953	1	4787614	1	4792636	1
LSES 132 MU - VMA A34T 900 SD <sup>2</sup>	9	4787602	1	4787608	1	4792623	1	4787615	1	4792637	1
LSES 160 MR - VMA 34T 111 SD <sup>2</sup>	11	4787635	1	4787636	1	4792624	1	4787637	1	4792638	1

1. Motors IM B5 / IM V1 - IM B35 / IM V5 - IM B14 / IM V18 - IM B34 / IM V58 2. Without button - Cable gland to the right.

**6**  
poles  
1000 min<sup>-1</sup>

**THREE-PHASE SUPPLY: VMA 31/32/33/34: from 400 V -10% to 480 V +10%, 50/60 Hz ±2%**  
**Three-phase motors 230/400V ±10% CONNECTED Y**

Type	Rated power at 50 Hz $P_N$ kW	IM 1001 <sup>1</sup> (IM B3)		IM 3001 <sup>1</sup> (IM B5)		IM 2001 <sup>1</sup> (IM B35)		IM 3601 <sup>1</sup> (IM B14)		IM 2101 <sup>1</sup> (IM B34)	
		Code	Qty	Code	Qty	Code	Qty	Code	Qty	Code	Qty
LS 71 L - VMA A31T 025 SD <sup>2</sup>	0.25	4498499	2	4484975	2	-	-	4498503	2	-	-
LS 80 L - VMA A31T 037 SD <sup>2</sup>	0.37	4421531	2	4421533	2	-	-	4421534	2	-	-
LS 80 L - VMA A31T 055 SD <sup>2</sup>	0.55	4421535	2	4421536	2	-	-	4421537	2	-	-
LSES 90 S - VMA A31T 075 SD <sup>2</sup>	0.75	4787616	2	4787623	2	4792641	2	4787628	2	4792741	2
LSES 90 L - VMA A32T 110 SD <sup>2</sup>	1.1	4787617	2	4766005	2	4792732	2	4787629	2	4792742	2
LSES 100 L - VMA A32T 150 SD <sup>2</sup>	1.5	4787618	2	4787624	2	4792733	2	4787630	2	4792743	2
LSES 112 MG - VMA A32T 220 SD <sup>2</sup>	2.2	4787619	2	4763664	2	4792734	2	4787631	2	4792744	2
LSES 132 S - VMA A32T 300 SD <sup>2</sup>	3	4787620	1	4787625	1	4792735	1	4787632	1	4792745	1
LSES 132 M - VMA A33T 400 SD <sup>2</sup>	4	4787621	1	4787626	1	4792738	1	4787633	1	4792747	1
LSES 132 MU - VMA A33T 550 SD <sup>2</sup>	5.5	4787622	1	4787627	1	4792740	1	4787634	1	4792748	1
LSES 160 M - VMA A34T 750 SD <sup>2</sup>	7.5	-	-	-	-	-	-	-	-	-	-
LSES 160 LU - VMA 34T 111 SD <sup>2</sup>	11	-	-	-	-	-	-	-	-	-	-

1. Motors IM B5 / IM V1 - IM B35 / IM V5 - IM B14 / IM V18 - IM B34 / IM V58 2. Without button - Cable gland to the right.

DG < 2 WD < 5 WD < To agree

DG: Availability ; n WD: Working Days (at the departure of the factory).

