

GENERAL CATALOG

2014



1

**ELECTRONICS IN THE
CONTROL CABINET**



2

INTERFACES



3

**CONNECTION
TECHNOLOGY**



4

I/O SYSTEMS



MURRELEKTRONIK GOES EVEN GREENER!

Being sustainable and respecting nature are part of our core values here. That's why we print our catalogs on uncoated paper which is produced without any solvents, chlorine and is environmentally friendly. Our supply chain is also an environmentally friendly production process.

We, here at Murrelektronik, are proud to say we act responsibly and protect the environment.



Note:

With this new main catalog, all information contained in previous brochures/catalogs expires. All drawings, diagrams, indications of weight, dimensions, ratings or other details printed in this catalog are only binding when specifically agreed upon.

Murrelektronik reserves the right to changes and modifications. The customer is responsible for using the components and units that they ordered in the way they are designed.

The information in this brochure has been compiled with the utmost care. Liability for the correctness, completeness and topicality of the information is restricted to gross negligence.

1st edition: October 2013

Part No. 9800012

Murrelektronik GmbH,
Falkenstr. 3, D-71570 Oppenweiler

www.murrelektronik.com

With compliments:

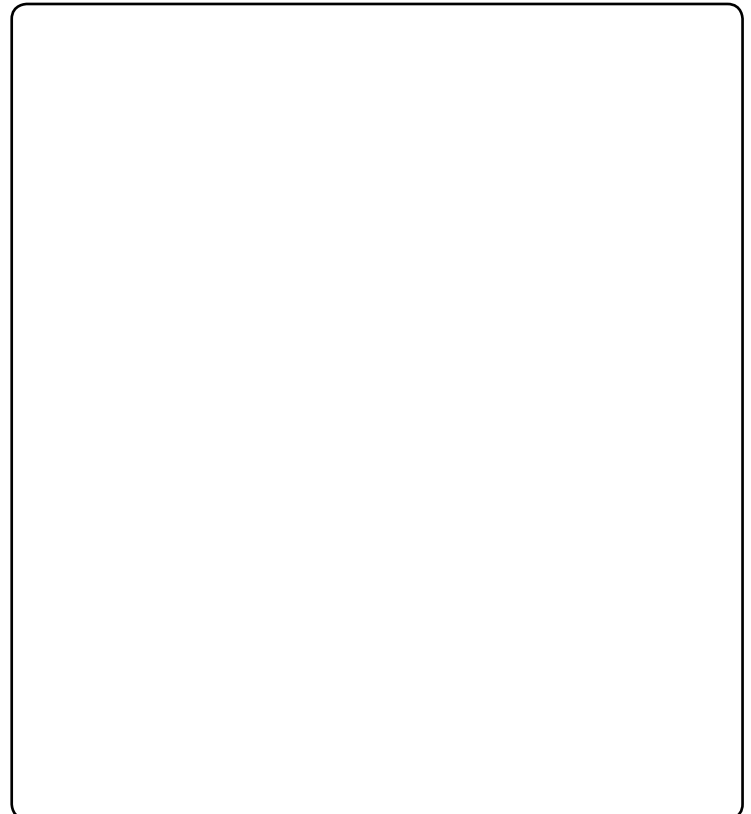

GENERAL CATALOG

PRODUCT NEWS



SOME OF THE NEW PRODUCTS IN THIS CATALOG:

NEW



EMPARRO SIMPLY THE BEST

- Efficiency up to 95 %
- 150 % Power Boost
- Practical metal housing

Page 1.3.1

NEW



CUBE20S SMALL, SPEEDY, SAFE

- Quick setup and service
- Repeater included

Page 4.3.1

NEW



MVK SAFETY ACTIVE SAFETY

- Optimum protection
- Safe inputs/outputs
- Easy installation

Page 4.4.12

NEW



ETHERNET CABLES FOR ANY CONNECTION

- Plug available in five different angles
- Cables suitable for C-Tracks
- Molded or field-wireable

Page 3.6.7

NEW



MICO+ INTELLIGENTLY SECURED

- Protects 24 V DC systems
- 90 % warning as digital signal
- Shut off channels with control

Page 1.5.1

NEW



MODLIGHT XTREME 440 FOR PERFECT LIGHTING

- Bright as daylight
- IP69K for the toughest environments
- Energy saving LED technology

Page 2.4.4

NEW



MODLINK MSDD FRONT PANEL INTERFACES

- For service work
- IP65 protection
- Modular Inserts

Page 2.1.1

NEW



... AND MANY MORE NEW PRODUCTS

1

ELECTRONICS IN THE CONTROL CABINET



- 1.1** Transformers
- 1.2** Rectified Power Supplies
- 1.3** Power Supply Units
- 1.4** Buffer Modules / Redundancy Modules
- 1.5** Intelligent Power Distribution
- 1.6** Converters / Rectifiers
- 1.7** Control Cabinet Power Outlets
- 1.8** EMC Filters
- 1.9** EMC Suppressors
- 1.10** Relays / Safety Relays
- 1.11** Optocouplers / Semiconductors
- 1.12** Active Interface Technology
- 1.13** Passive Interface Technology
- 1.14** Eurocard Holders / Control Modules

2

INTERFACES



- 2.1** Front Panel Interfaces
- 2.2** Control Cabinet Interfaces / Cable Entry Systems
- 2.3** Hybrid Fieldbus Coupling
- 2.4** Lighting Elements

3

CONNECTION TECHNOLOGY



- 3.1** M8 Round Plug Connectors
- 3.2** M12 Round Plug Connectors
- 3.3** T-couplers M8, M12, 7/8"
- 3.4** Flange Connectors
- 3.5** MQ12 Round Plug Connectors
- 3.6** Fieldbus Connectors
- 3.7** Plug Connectors for Food & Beverage
- 3.8** M23 Round Plug Connectors
- 3.9** 7/8" Round Plug Connectors
- 3.10** Valve Connectors
- 3.11** Technical Appendix

4

I/O SYSTEMS



- 4.1** Cube67
- 4.2** Cube20
- 4.3** Cube20S
- 4.4** MVK Metal
- 4.5** Impact67
- 4.6** Impact20
- 4.7** MASI00/20
- 4.8** MASI67
- 4.9** MASI68
- 4.10** M8 Distribution Systems
- 4.11** M12 Distribution Systems (Metal)
- 4.12** M12 Distribution Systems (Plastic)



**24 BRANCH OFFICES
AND 4 PRODUCTION PLANTS**

Oppenweiler
Production Fieldbus Systems,
Interface modules

Stollberg, Germany
Production of Connectors

Stod, Czech Republic
Production of Interface, Switch Mode
Power Supplies, Transformers



**STAY CONNECTED – REPRESENTED
ON ALL CONTINENTS WORLDWIDE**

The company was founded in
1975 by Franz Hafner

Over 1,800 employees, including
200 sales reps and customer
service center technicians

Top student training is very important
for Murrelektronik. Each year we offer
apprenticeships in technical and
commercial areas, as well as in logistics.





MURRELEKTRONIK FIGURES & FACTS

Shanghai, China
Production for the
Asian markets



MURRELEKTRONIK IS YOUR PARTNER...

- Over 42,000 products available to order conveniently in our online shop
- Subdivided into four product fields:
 - **Electronics in the Control Cabinet**
 - **Interfaces**
 - **Connection Technology**
 - **I/O Systems**
- For industries and market segments as for example:
 - **Machine Tools**
 - **Machine Building and Plant Engineering**
 - **Assembly and Handling Technology**
 - **Food and Beverage**
 - **Automotive Industry**
 - **Warehousing and Logistics**
- Founded in Oppenweiler, Germany, in 1975
- Family-owned company
- Over €190 million turnover in the year 2012



**CUSTOMER
LOYALTY WITH
INDIVIDUAL
AND
COMPETENT
ON-SITE HELP**

MURRELEKTRONIK OFFER VALUABLE BENEFITS

- Over 200 sales reps
- On-site support
- 4 international warehouses
- 1 million products in stock

- Murrelektronik Express Service

mex
More service

MURRELEKTRONIK YOUR BENEFITS



International approvals for flexible applications worldwide



MURRELEKTRONIK QUALITY



MURRELEKTRONIK STANDS FOR QUALITY

- In-house test center and EMC lab for tested and accredited products
- Individual and competent on-site advice and support
- No use of hazardous materials
- Complies with RoHS requirements
- First-class design and production quality
- Systematic and sustainable quality management according to DIN EN ISO 9001

Tested and accredited:
In-house test center
and EMC laboratory



Endurance tests
under extreme
conditions



Product testing begins
at the beginning of the
project





connec+ivity[®]
by Murrelektronik

THE BACK BONE OF YOUR MACHINE AND SYSTEM INSTALLATIONS

ASSESSING STATUS

- On-site analysis
- Exchanging the basic documentation
- Discussing the current status

SELECTING THE DESIGN

- Concept overview
- Analyzing advantages and disadvantages
- Bills of materials

CREATING A CONCEPT

- Customer-specific requirements
- Industry-specific requirements
- Several concept options

PROJECT SUPPORT

- E-plan and CAD data
- Electronic catalog data (BMEcat)
- Setup support

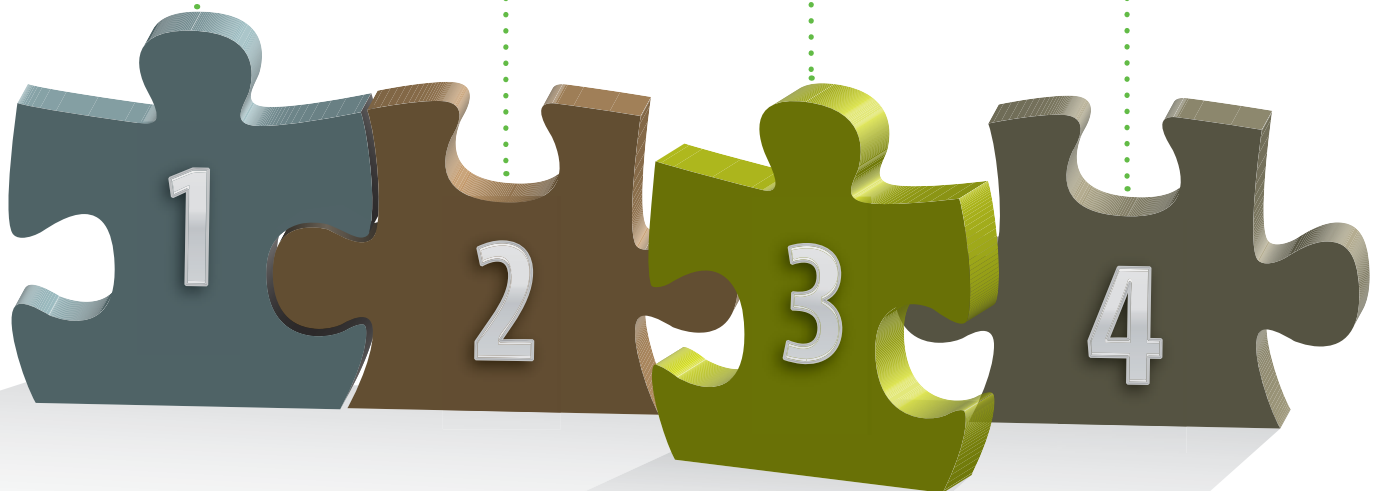

CONNECTIVITY BY MURRELEKTRONIK

CONNECTIVITY MEANS INDIVIDUAL SOLUTIONS

- Best advice increases your competitive advantage
- Decrease your budget significantly
- We optimize your machine and system installation
- Highly skilled, specially trained staff
- Individual system solutions
- Consistent from a single source

SYSTEM ADVICE WITH CONNECTIVITY CITY

Go from the industry overview
to your application ...

... to the appropriate products.



Download the
CONNECTIVITY app
for your iPad here:

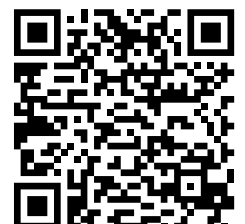

MURRELEKTRONIK REPRESENTED ON ALL CONTINENTS WORLDWIDE



GERMANY

Murrelektronik GmbH
Falkenstraße 3
D-71570 Oppenweiler
Phone +49 7191 47-0
Fax +49 7191 47-491000
info@murrelektronik.de
www.murrelektronik.de



ARGENTINA

NAKASE SRL
ventas@nakase.com
www.nakase.com.ar



AUSTRALIA

Sick Pty. Ltd.
sales@sick.com.au
www.sick.com.au



AUSTRIA

Murrelektronik GmbH
info@murrelektronik.at
www.murrelektronik.at



BELGIUM

Murrelektronik B.V.B.A.
info@murrelektronik.be
www.murrelektronik.be



BRAZIL

Murrelektronik do Brasil
Indústria e Comércio Ltda.
info@murrelektronik.com.br
www.murrelektronik.com.br



BULGARIA

Murrelektronik GmbH
info@murrelektronik.at
www.murrelektronik.at



CANADA

Murrelektronik Canada
2sales@murrelektronik.ca
www.murrelektronik.ca



CHILE

Electrónica Rhomberg Ltda.
ventas@rhomberg.cl
www.rhomberg.cl



CHINA

Murrelektronik Components Co. Ltd.
info@murrelektronik.com.cn
www.murrelektronik.com.cn



CROATIA

Murrelektronik GmbH
info@murrelektronik.at
www.murrelektronik.at



CZECH REPUBLIC

Murrelektronik CZ spol. s.r.o.
info@murrelektronik.cz
www.murrelektronik.cz



DENMARK

Murrelektronik Aps
info@murrelektronik.dk
www.murrelektronik.dk



EGYPT

DANA Import & Export
usama@dana-egy.com
www.murrelektronik.com/en



FINLAND

Murrelektronik Power Oy
sales@murrelektronik.fi
www.murrelektronik.fi



FRANCE

Murrelektronik S.A.S.
info@murrelektronik.fr
www.murrelektronik.fr



GREAT BRITAIN

Murrelektronik Ltd.
sales@murrelektronik.co.uk
www.murrelektronik.co.uk



HUNGARY

Murrelektronik Kft.
info@murrelektronik.hu
www.murrelektronik.hu



INDIA

B.I. Enterprise
balluff@balluff.co.in
www.balluff.co.in



ISRAEL

O.M.S.T Marketing & Import Ltd.
miki@omst.co.il
www.omst.co.il



ISRAEL

Ancitech Ltd.
info@ancitech.com
www.ancitech.com



ITALY

Murrelektronik S.r.l.
info@murrelektronik.it
www.murrelektronik.it



JAPAN

K.MECS Co., Ltd.
info@kmecs.co.jp
www.kmecs.co.jp



KENIA

Profa-Tech Limited
info@profa-tech.com
www.profa-tech.com



NETHERLANDS

Murrelektronik B.V.
sales@murrelektronik.nl
www.murrelektronik.nl

MURRELEKTRONIK REPRESENTED WORLDWIDE

**NEW ZEALAND**

Sick Pty. Ltd.
sales@sick.co.nz
www.sick.co.nz

**NORWAY**

Murrelektronik A.S.
post@murrelektronik.no
www.murrelektronik.no

**PAKISTAN**

Overseas Enterprises
info@oe.com.pk
rehan_k@oe.com.pk
www.oe.com.pk

**POLAND**

Murrelektronik Sp. z o.o.
info@murrelektronik.pl
www.murrelektronik.pl

**PORTUGAL**

F.Fonseca S.A.
ffonseca@ffonseca.com
www.ffonseca.com

**ROMANIA**

Murrelektronik GmbH
info@murrelektronik.at
www.murrelektronik.at

**RUSSIA**

Murrelektronik
igor.kalinin@murrelektronik.de
www.murrelektronik.ru

**SERBIA**

Murrelektronik GmbH
info@murrelektronik.at
www.murrelektronik.at

**SINGAPORE**

Balluff Asia Pte. Ltd.
balluff@balluff.com.sg
www.balluff.com.sg

**SLOVAKIA**

Murrelektronik s.r.o.
info@murrelektronik.sk
www.murrelektronik.sk

**SLOVENIA**

Murrelektronik GmbH
info@murrelektronik.at
www.murrelektronik.at

**SPAIN**

Murrelektronik Spain S.L.U.
ventas@murrelektronik.es
www.murrelektronik.es

**SOUTH AFRICA**

Rubicon Electrical
and Automation
greg@rubiconsa.com
www.rubiconsa.com

**SOUTH KOREA**

Murrelektronik Korea Ltd.
info@murrelektronik.kr
www.murrelektronik.kr

**SWEDEN**

Murrelektronik AB
info@murrelektronik.se
www.murrelektronik.se

**SWITZERLAND**

Murrelektronik AG
info@murrelektronik.ch
www.murrelektronik.ch

**TAIWAN**

Lintronix Co. Ltd.
info@lintronix.com.tw
www.lintronix.com.tw

**THAILAND**

Maxtech Control Co., Ltd.
info@maxtechcontrol.co.th
www.maxtechcontrol.co.th

**TURKEY**

Murr Elektronik San. ve Tic. Ltd. Sti
erkan.balikci@murrelektronik.com.tr
www.murrelektronik.com.tr

**UNITED ARAB EMIRATES**

King Power Electrical Accessories
Trading
kpower@emirates.net.ae
www.murrelektronik.com/en

**USA**

Murrelektronik Inc.
2info@murrinc.com
www.murrinc.com

**VIETNAM**

OMINA Industrial Automation J.S.C
inquiry@omina.com.vn
www.omina.com.vn

ELECTRONICS IN THE CONTROL CABINET

1



1

ELECTRONICS IN THE CONTROL CABINET

2

INTERFACES

3

CONNECTION TECHNOLOGY

4

I/O SYSTEMS

Transformers

1.1

Rectified Power Supplies

1.2

Power Supply Units

1.3

Buffer Modules / Redundancy Modules

1.4

Intelligent Power Distribution

1.5

Converters / Rectifiers

1.6

Control Cabinet Power Outlets

1.7

EMC Filters

1.8

EMC Suppressors

1.9

Relays / Safety Relays

1.10

Optocouplers / Semiconductors

1.11

Active Interface Technology

1.12

Passive Interface Technology

1.13

Eurocard Holders / Control Modules

1.14



TRANSFORMERS SAFE AND RELIABLE

- Approvals for the global market
- Flexible and versatile
- Customized solutions

MTS, MST, MET OR MTL – THE RIGHT TRANSFORMER FOR EVERY APPLICATION

Different situations require different voltages. Transformers have to be just as flexible as the application. Murrelektronik's range provides you with the flexibility you need! No matter if it's an isolation transformer, control transformer, or safety transformer – we have the right solution for any application. Murrelektronik's transformers are reliable, safe and their approvals and voltage ranges make them ideal for worldwide use.

Transformers



MTS – Isolation class T 40/B

- Nominal power rating: 40...250 VA
- Input voltage: 230, 400 V AC or multi voltage (± 15 V AC)
- Output voltage: 24 V AC or 230 V AC
- Ambient temperature: 40 °C

Page 1.1.1



MST – Isolation class T 40/B

- Nominal power rating: 320...1000 VA
- Input voltage: 230, 400 V AC or multi voltage
- Output voltage: 24 V AC or 230 V AC
- Ambient temperature: 40 °C

Page 1.1.4



MET – Isolation class T 60/B

- Nominal power rating: 500...5000 VA
- Input voltage: 230 V AC $\pm 5\%$, 400 V AC $\pm 5\%$, 240/415 V AC $\pm 5\%$
- Output voltage: 24, 230, 110/240 V AC
- Ambient temperature: 60 °C

Page 1.1.7



MTL – Isolation class T 60/B

- Nominal power rating: 25...2500 VA
- Input voltage: 230/400 V AC ± 15 V AC
- Output voltage: 2 x 24 V AC or 2 x 115 V AC
- Ambient temperature: 60 °C

Page 1.1.11

TRANSFORMERS

1-/2-phase

– INPUT: 230/400 V AC

– Isolation class T 40/B

Approvals:  

MTS

OUTPUT: 230 V AC
Screw terminals



MTS

OUTPUT: 230 V AC
Spring clamp terminals

MTS

OUTPUT: 24 V AC
Screw terminals

MTS

OUTPUT: 24 V AC
Spring clamp terminals

Circuit diagram

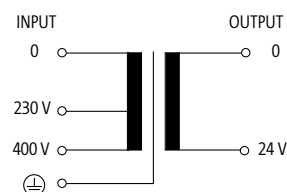
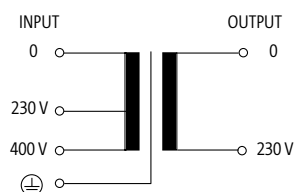

Order Data	HxWxD/kg	Art-No.	HxWxD/kg	Art-No.	HxWxD/kg	Art-No.	HxWxD/kg	Art-No.
40 VA	79x78x93/0.8	86346	79x78x93/0.8	6686346	79x78x93/0.8	86340	79x78x93/0.8	6686340
63 VA	79x78x93/1.2	86347	79x78x93/1.2	6686347	79x78x93/1.2	86341	79x78x93/1.2	6686341
100 VA	86x84x98/2.0 – GL	86348	86x84x98/2.0	6686348	86x84x98/2.0 – GL	86342	86x84x98/2.0	6686342
160 VA	101x96x106/2.7 – GL	86349	101x96x106/2.7	6686349	101x96x106/2.7 – GL	86343	101x96x106/2.7	6686343
250 VA	102x96x108/3.5 – GL	86351	102x96x108/3.5	6686351	102x96x108/3.5 – GL	86345	102x96x108/3.5	6686345

Input		
Frequency	50/60 Hz	
Input voltage	230/400 V AC	
Output		
Output voltage	230 V AC	24 V AC (SELV)
General data		
Standards	(EN 61558-1), (EN 61558-2-4), (EN 62041 category 0)	
Test isolation voltage	4 kV (prim./sec.)	
Temperature range	-20...+40 °C, no condensation	
Mounting method	Long-hole mounting or DIN-rail mountable TH35 (EN 60715)	

Dimension drawing

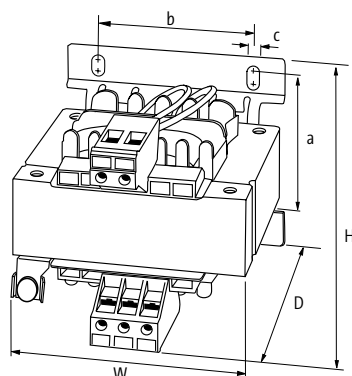

Murrelektronik Online Shop
onlineshop.murrelektronik.com/en

Notes
GL-Approval from 100 VA and with screw terminals

TRANSFORMERS

1-/2-phase

– INPUT: 230/400 ±15 V AC

– Isolation class T 40/B

Approvals:  

MTS+
OUTPUT: 230 V AC
Screw terminals



MTS+
OUTPUT: 230 V AC
Spring clamp terminals



MTS+
OUTPUT: 24 V AC
Screw terminals



MTS+
OUTPUT: 24 V AC
Spring clamp terminals



Circuit diagram

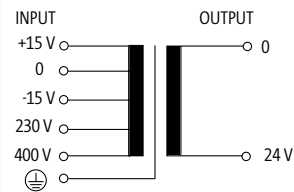
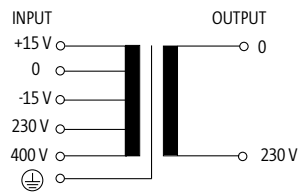

Order Data	HxWxD/kg	Art-No.	HxWxD/kg	Art-No.	HxWxD/kg	Art-No.	HxWxD/kg	Art-No.
40 VA	79x78x93/0.8	86366	79x78x93/0.8	6686366	79x78x93/0.8	86360	79x78x93/0.8	6686360
63 VA	79x78x93/1.2	86367	79x78x93/1.2	6686367	79x78x93/1.2	86361	79x78x93/1.2	6686361
100 VA	86x84x98/2.0 – GL	86368	86x84x98/2.0	6686368	86x84x98/2.0 – GL	86362	86x84x98/2.0	6686362
160 VA	101x96x106/2.7 – GL	86369	101x96x106/2.7	6686369	101x96x106/2.7 – GL	86363	101x96x106/2.7	6686363
250 VA	102x96x108/3.5 – GL	86371	102x96x108/3.5	6686371	102x96x108/3.5 – GL	86365	102x96x108/3.5	6686365

Input	
Input voltage	230/400 ±15 V AC
Frequency	50/60 Hz
Output	
Output voltage	230 V AC 24 V AC (SELV)
General data	
Standards	(EN 61558-1), (EN 61558-2-4), (EN 62041 category 0) (EN 61558-1), (EN 61558-2-6), (EN 62041 category 0)
Test isolation voltage	4 kV (prim./sec.)
Temperature range	-20...+40 °C, no condensation
Mounting method	Long-hole mounting or DIN-rail mountable TH35 (EN 60715)

Dimension drawing

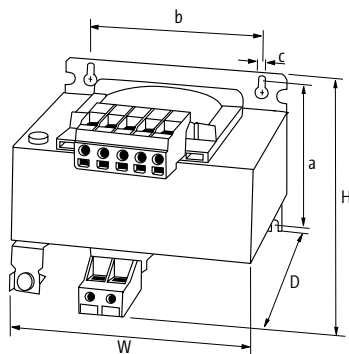

Murrelektronik Online Shop
onlineshop.murrelektronik.com/en

Notes

GL-Approval from 100 VA and with screw terminals

TRANSFORMERS

1-/2-phase

– Multi voltage output

– Isolation class T 40/B

Approvals:  

MTS Multi

OUTPUT: 2 × 115 V AC/230 V AC
Screw terminals



Circuit diagram

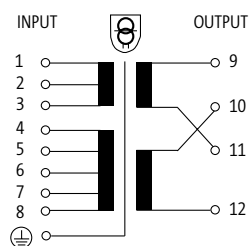

Order Data	H×W×D/kg	Art-No.
25 VA	90×78×102/0.7	86140
40 VA	88×78×93/1.1	86141
63 VA	97×78×93/1.4	86142
100 VA	105×84×98/2.0 – GL	86143
160 VA	101×96×106/2.7 – GL	86144

Input	
Input voltage	208, 230, 380, 400, 440, 460, 480, 500, 525, 550 V AC
Frequency	50/60 Hz
Output	
Output voltage	2 × 115 V AC/230 V AC
General data	
Standards	(EN 61558-1), (EN 61558-2-4), (EN 62041 category 0)
Test isolation voltage	4 kV (prim./sec.)
Temperature range	-20...+40 °C, no condensation
Mounting method	Long-hole mounting or DIN-rail mountable TH35 (EN 60715)

Dimension drawing

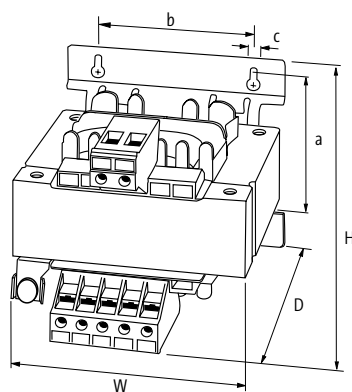

Murrelektronik Online Shop
onlineshop.murrelektronik.com/en

Notes
GL-Approval from 100 VA and with screw terminals

TRANSFORMERS

1-/2-phase

– INPUT: 230/400 V AC

– Isolation class T 40/B

Approvals:  

MST

OUTPUT: 230 V AC
Screw terminals



MST

OUTPUT: 230 V AC
Spring clamp terminals

MST

OUTPUT: 24 V AC
Screw terminals

MST

OUTPUT: 24 V AC
Spring clamp terminals

Circuit diagram

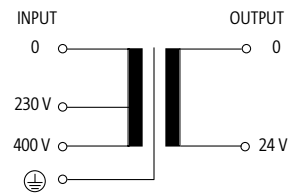
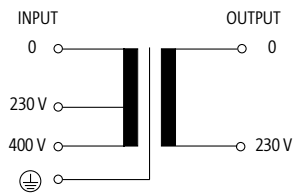

Order Data	HxWxD/kg	Art-No.	HxWxD/kg	Art-No.	HxWxD/kg	Art-No.	HxWxD/kg	Art-No.
320 VA	92x120x122/4.2 – GL	86306	92x120x122/4.2	6686306	92x120x122/4.2 – GL	86326	92x120x122/4.2	6686326
400 VA	104x120x122/5.2 – GL	86307	104x120x122/5.2	6686307	104x120x122/5.2 – GL	86327	104x120x122/5.2	6686327
500 VA	108x135x134/6.5 – GL	86308	108x135x134/6.5	6686308	108x135x134/6.5 – GL	86328		
630 VA	113x150x145/7.7 – GL	86309	113x150x145/7.7	6686309	113x150x145/7.7 – GL	86329		
800 VA	129x150x145/10.1 – GL	86310	129x150x145/10.1	6686310	136x150x149/10.1 – GL	86330		
1000 VA	128x174x160/12.3 – GL	86311	128x174x160/12.3	6686311	133x174x165/12.3 – GL	86331		

Input

Input voltage 230/400 V AC
Frequency 50/60 Hz

Output

Output voltage 230 V AC 24 V AC (SELV)

General data

Standards (EN 61558-1), (EN 61558-2-4), (EN 62041 category 0) (EN 61558-1), (EN 61558-2-6), (EN 62041 category 0)
Test isolation voltage 4 kV (prim./sec.)
Temperature range -20...+40 °C, no condensation
Mounting method Key-hole mounting

Dimension drawing

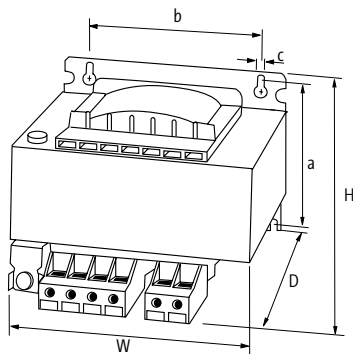

Murrelektronik Online Shop
onlineshop.murrelektronik.com/en

Notes

TRANSFORMERS

1-/2-phase

– INPUT: 230/400 ±15 V AC

– Isolation class T 40/B

Approvals:   

MST+

OUTPUT: 24 V AC, 48 V AC
Screw terminals



MST+

OUTPUT: 115 V AC, 230 V AC
Screw terminals

Circuit diagram

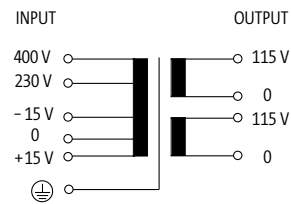
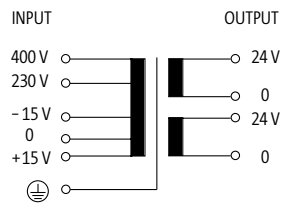

Order Data	H×W×D/kg	Art-No.	H×W×D/kg	Art-No.
630 VA	121×150×165/8.0	86463	113×150×146/8.2	86483
1000 VA	156×150×197/13.5	86464	156×150×146/13.5	86484
1600 VA	168×174×222/19.5	86465	168×174×163/19.5	86485
2500 VA	182×192×242/27.0	86466	182×192×196/27.0	86486

Input	
Input voltage	230/400 ±15 V AC
Frequency	50/60 Hz
Output	
Output voltage	1 × 24, 1 × 48, 2 × 24 V AC 1 × 230, 1 × 115, 2 × 115 V AC
General data	
Standards	(EN 61558-1), (EN 61558-2-4), (EN 62041 category 0)
Test isolation voltage	5.8 kV (prim./sec.)
Temperature range	-20...+40 °C, no condensation
Mounting method	Key-hole mounting
Dimension drawing	

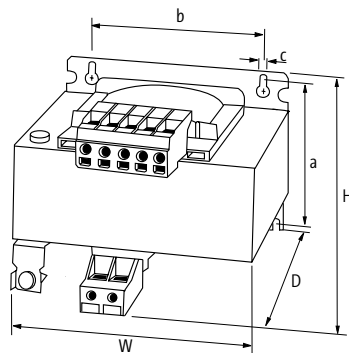

Murrelektronik Online Shop
onlineshop.murrelektronik.com/en

Notes

TRANSFORMERS

1-/2-phase

– INPUT: 208...520 V AC

– Isolation class T 40/B

Approvals:   

MST Multi

OUTPUT: 2 × 115 V AC/230 V AC

Screw terminals



Circuit diagram

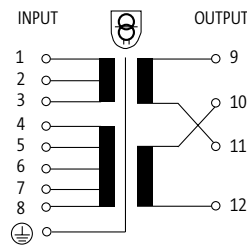

Order Data	H×W×D/kg	Art-No.
250 VA	104×120×122/4.0	86145
320 VA	115×135×132/5.8	86146
400 VA	115×135×132/6.2	86147
500 VA	108×135×134/6.5	86148
800 VA	129×150×145/10.1	86150
1000 VA	128×174×160/12.3	86151
1600 VA	128×174×160/12.3	86152
2000 VA	128×174×160/12.3	86153
2500 VA	200×195×217/26.3	86154
3000 VA	250×197×193/29.5	86155
5000 VA	248×147×250/37.0	86157

Input

Input voltage 208, 230, 380, 400, 440, 460, 480, 500, 525, 550 V AC

Frequency 50/60 Hz

Output

Output voltage 2 × 115 V AC/230 V AC

General data

Standards (EN 61558-1), (EN 61558-2-4), (EN 62041 category 0)

Test isolation voltage 4 kV (prim./sec.)

Temperature range -20...+40 °C, no condensation

Mounting method Key-hole mounting

Dimension drawing

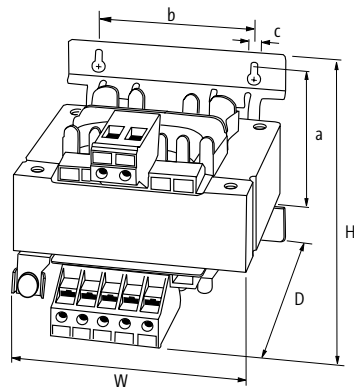

Murrelektronik Online Shop
onlineshop.murrelektronik.com/en

Notes

TRANSFORMERS

1-/2-phase

– OUTPUT: 230 V AC

– Isolation class T 60/B

Approvals:

MET

INPUT: 230 V AC ±5 %
Screw terminals



MET

INPUT: 230 V AC ±5 %
Spring clamp terminals

MET

INPUT: 400 V AC ±5 %
Screw terminals

MET

INPUT: 400 V AC ±5 %
Spring clamp terminals

Circuit diagram

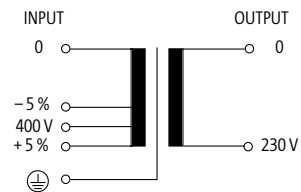
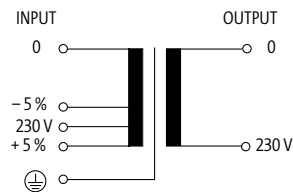

Order Data	HxWxD/kg	Art-No.	HxWxD/kg	Art-No.	HxWxD/kg	Art-No.	HxWxD/kg	Art-No.
500 VA	113x150x146/6.8 – GL	86020	113x150x146/6.8	6686020	113x150x146/6.8 – GL	86021	113x150x146/6.8	6686021
630 VA	131x150x148/8.2 – GL	86030	131x150x148/8.2	6686030	130x150x146/8.2 – GL	86031	130x150x146/8.2	6686031
800 VA	118x175x160/11.2 – GL	86040	118x175x160/11.2	6686040	118x175x160/11.2 – GL	86041	118x175x160/11.2	6686041
1000 VA	138x174x160/14.8 – GL	86050	138x174x160/14.8	6686050	138x174x160/14.8 – GL	86051	138x174x160/14.8	6686051
1500 VA	168x174x162/21.0 – GL	86060	168x174x162/21.0	6686060	168x174x162/21.0 – GL	86061	168x174x162/21.0	6686061

Input		
Input voltage	230 V AC ±5 %	400 V AC ±5 %
Frequency	50/60 Hz	

Output	
Output voltage	230 V AC

General data	
Standards	(EN 61558-1), (EN 61558-2-4), (EN 62041 category 0)

Test isolation voltage	4 kV (prim./sec.)
------------------------	-------------------

Temperature range	-20...+60 °C, no condensation
-------------------	-------------------------------

Mounting method	Key-hole mounting
-----------------	-------------------

Dimension drawing

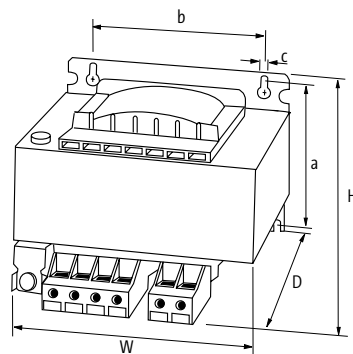

Murrelektronik Online Shop
onlineshop.murrelektronik.com/en

Notes

TRANSFORMERS

1-/2-phase

– OUTPUT: 110/240 V AC

– Isolation class T 60/B

Approvals:  

MET

INPUT: 240/415 V AC
Screw terminals



MET

INPUT: 240/415 V AC
Spring clamp terminals

Circuit diagram

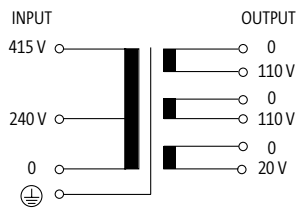

Order Data	HxWxD/kg	Art-No.	HxWxD/kg	Art-No.
500 VA	113x150x170/6.8 – GL	86025	113x150x170/6.8	6686025
630 VA	129x150x148/8.2 – GL	86035	129x150x148/8.2	6686035
800 VA	118x174x148/11.2 – GL	86045	118x174x148/11.2	6686045
1000 VA	138x174x160/14.8 – GL	86055	138x174x160/14.8	6686055

Input	
Input voltage	240/415 V AC
Output	
Output voltage	110/240 V AC
General data	
Standards	(EN 61558-1), (EN 61558-2-4), (EN 62041 category 0)
Test isolation voltage	4 kV (prim./sec.)
Temperature range	-20...+60 °C, no condensation
Mounting method	Key-hole mounting
Dimension drawing	

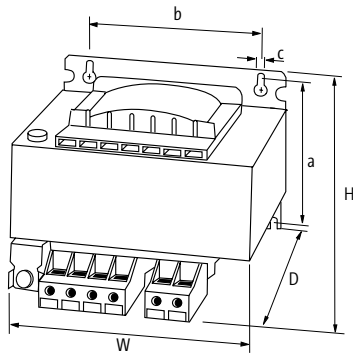

Murrelektronik Online Shop
onlineshop.murrelektronik.com/en

Notes

TRANSFORMERS

1-/2-phase

– OUTPUT: 230 V AC

– Isolation class T 40/B

Approvals:

MET

INPUT: 230 V AC
Screw terminals

MET

INPUT: 230 V AC
Spring clamp terminals

MET

INPUT: 400 V AC
Screw terminals

MET

INPUT: 400 V AC
Spring clamp terminals



Circuit diagram

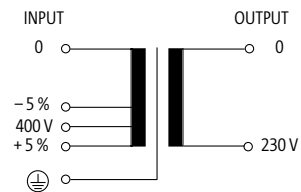
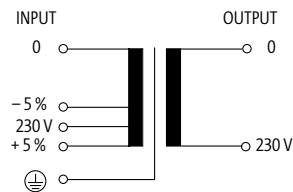

Order Data	HxWxD/kg	Art-No.	HxWxD/kg	Art-No.	HxWxD/kg	Art-No.	HxWxD/kg	Art-No.
2000 VA	170x195x250/24.0 – GL	86070	170x195x250/24.0	6686070	170x195x250/24.0 – GL	86071	170x195x250/24.0	6686071
3000 VA	195x198x250/30.0 – GL	86090	195x198x250/30.0	6686090	195x198x250/30.0 – GL	86091	195x198x250/30.0	6686091
4000 VA	206x198x250/32.0 – GL	86110	206x198x250/32.0	6686110	206x198x250/32.0 – GL	86111	206x198x250/32.0	6686111
5000 VA	225x198x250/40.0 – GL	86130	225x198x250/40.0	6686130	225x198x250/40.0 – GL	86131	225x198x250/40.0	6686131

Input	
Input voltage	230 V AC ±5 %
Frequency	50/60 Hz
Output	
Output voltage	230 V AC
General data	
Standards	(EN 61558-1), (EN 61558-2-4), (EN 62041 category 0)
Test isolation voltage	4 kV (prim./sec.)
Temperature range	-20...+40 °C, no condensation
Mounting method	Long-hole mounting
Dimension drawing	

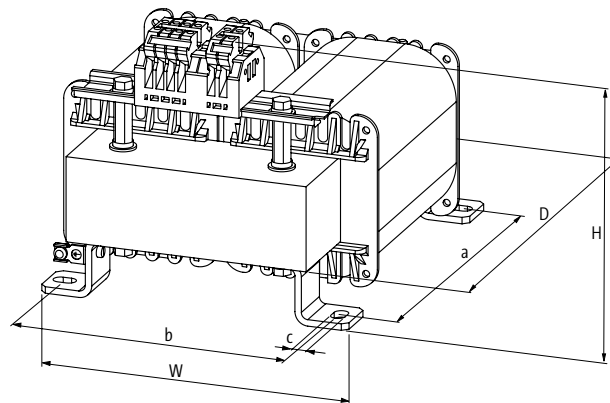

Murrelektronik Online Shop
onlineshop.murrelektronik.com/en

Notes

TRANSFORMERS

1-/2-phase

– OUTPUT: 24 V AC

– Isolation class T 60/B

Approvals:   

MET

INPUT: 230 V AC
Screw terminals



MET

INPUT: 400 V AC
Screw terminals

Circuit diagram

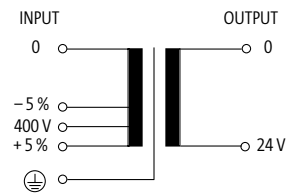
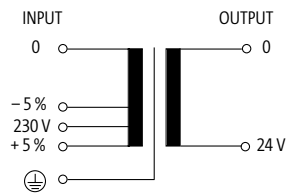

Order Data	HxWxD/kg	Art-No.	HxWxD/kg	Art-No.
500 VA	113x150x146/6.8	86023	113x150x146/6.8	86024
630 VA	129x150x148/8.2	86033	129x150x148/8.2	86034
800 VA	117x174x160/11.2	86043	117x174x160/11.2	86044
1000 VA	137x174x160/14.8	86053	137x174x160/14.8	86054

Input		
Input voltage	230 V AC $\pm 5\%$	400 V AC $\pm 5\%$
Frequency	50/60 Hz	

Output	
Output voltage	24 V AC (SELV)

General data	
Standards	(EN 61558-1), (EN 61558-2-6), (EN 62041 category 0)
Test isolation voltage	4 kV (prim./sec.)
Temperature range	-20...+60 °C, no condensation
Mounting method	Key-hole mounting

Dimension drawing

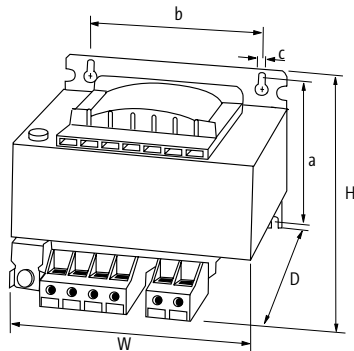

Murrelektronik Online Shop
onlineshop.murrelektronik.com/en

Notes

TRANSFORMERS

1-/2-phase

– INPUT: 230/400 ±15 V AC

– Isolation class T 60/B

Approvals:   



MTL

OUTPUT: 24 V AC, 48 V AC
Screw terminals



MTL

OUTPUT: 115 V AC, 230 V AC
Screw terminals

Circuit diagram

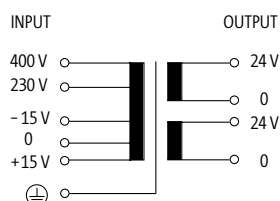

Order Data	H×W×D/kg	Art-No.	H×W×D/kg	Art-No.
25 VA	108×87×98/1.1	86450	108×87×98/1.1	86470
40 VA	108×87×104/1.4	86451	108×87×104/1.4	86471
63 VA	108×87×116/2.0	86452	108×87×116/2.0	86472
100 VA	108×87×139/2.9	86453	108×87×139/2.9	86473
160 VA	153×123×128/4.4	86454	153×123×128/4.4	86474
250 VA	153×123×142/5.7	86455	153×123×142/5.7	86475
320 VA	153×123×160/7.2	86456	153×123×160/7.2	86476

Accessories	Art-No.
Label plates for MTL/MTPS	89661
Jumper	89660

Technical Data	
LED display	LED (green) for input voltage

Input	
Input voltage	230/400 ±15 V AC
Frequency	50/60 Hz

Output	
Output voltage	1 × 24, 1 × 48, 2 × 24 V AC 1 × 230, 1 × 115, 2 × 115 V AC

General data	
Standards	(EN 61558-2-4), (EN 61558-2-6), (EN 62041 category 0) (EN 61558-1), (EN 61558-2-4), (EN 62041 category 0)
Test isolation voltage	5.1 kV (prim./sec.) 4 kV (prim./sec.)
Temperature range	-20...+60 °C, no condensation
Mounting method	DIN-rail mountable TH35-15 (EN 60715) or for key-hole mounting

Dimension drawing

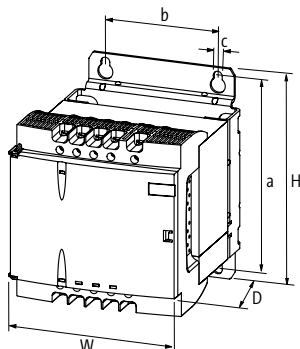

Murrelektronik Online Shop
onlineshop.murrelektronik.com/en

Notes

TRANSFORMERS

1-/2-phase

– INPUT: 230/400 ±15 V AC

– Isolation class T 60/B

Approvals:  

MTL

OUTPUT: 24 V AC, 48 V AC
Screw terminals



MTL

OUTPUT: 24 V AC, 48 V AC
Spring clamp terminals

Circuit diagram

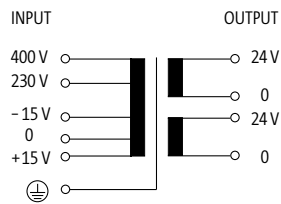

Order Data	HxWxD/kg	Art-No.	HxWxD/kg	Art-No.
400 VA	113x150x160/7.5 – ENEC, GL	86457	113x150x160/7.5	6686457
Input				
Input voltage	230/400 ±15 V AC			
Frequency	50/60 Hz			
Output				
Output voltage	1 × 24, 1 × 48, 2 × 24 V AC			
General data				
Standards	(EN 61558-2-4), (EN 61558-2-6), (EN 62041 category 0)			
Test isolation voltage	5.1 kV (prim./sec.)			
Temperature range	-20...+60 °C, no condensation			
Mounting method	DIN-rail mountable TH35-15 (EN 60715) or for key-hole mounting			
Dimension drawing				

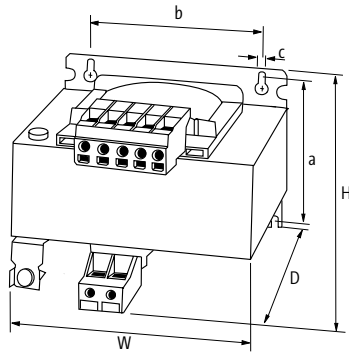

Murrelektronik Online Shop
onlineshop.murrelektronik.com/en

Notes

TRANSFORMERS

1-/2-phase

– INPUT: 230/400 ±15 V AC

– Isolation class T 60/B

Approvals:  

MTL

OUTPUT: 115 V AC, 230 V AC
Screw terminals



MTL

OUTPUT: 115 V AC, 230 V AC
Spring clamp terminals

Circuit diagram

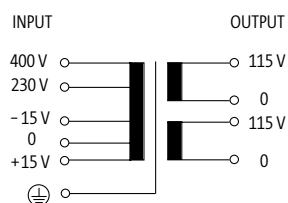

Order Data	H×W×D/kg	Art-No.	H×W×D/kg	Art-No.
400 VA	113×151×146/7.4 – ENEC, GL	86477	113×151×146/7.4	6686477
Input				
Input voltage	230/400 ±15 V AC			
Frequency	50/60 Hz			
Output				
Output voltage	1 × 230, 1 × 115, 2 × 115 V AC			
General data				
Standards	(EN 61558-1), (EN 61558-2-4), (EN 62041 category 0)			
Test isolation voltage	4 kV (prim./sec.)			
Temperature range	-20...+60 °C, no condensation			
Mounting method	DIN-rail mountable TH35-15 (EN 60715) or for key-hole mounting			

Dimension drawing

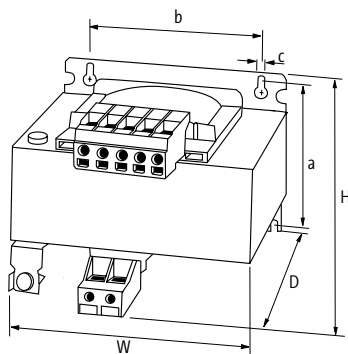

Murrelektronik Online Shop
onlineshop.murrelektronik.com/en

Notes



RECTIFIED POWER SUPPLIES

RELIABLE AND DURABLE

- Highly reliable
- Long life span saves money
- Low interference

BASIC FUNCTIONS

Rectified power supplies galvanically separate input and output. They convert mains voltage into Protected Extra Low Voltage. The electronic unit rectifies and smooths the voltage.

Rectified power supplies are designed for a frequency of 50/60 Hz. Their slow reaction prevents voltage spikes from being passed from the mains side to the output, which would interfere with peripheral devices.

They have fixing brackets with keyholes that ensure easy wall mounting. Models for DIN-rail mounting are available for applications up to 5 A.

Single-phase, single/two-phase, smoothed



MEN

- Input voltage: 115/230 V AC and 230/400 V AC
± 15 V AC reconnectable
- Output voltage: 24 V DC SELV
- Output current: 1.0/2.5/5/7.5/10/15/20 A

Page 1.2.1



MTPS

- Input voltage: 230/400 V AC
± 15 V AC reconnectable
- Output voltage: 24 V DC SELV
- Output current: 0.5/1/2/4/6/10 A

Page 1.2.5

Single-phase, linear regulated



MKN

- Input voltage: 230 V AC
± 15 V AC reconnectable
- Output voltage: 5/10/±10/±15 or 24 V DC
and 9.5...15 V DC (per SELV)
- Output current: 70...200 mA

Page 1.2.7

Three-phase, smoothed



MPL

- Input voltage: 3 x 400 V AC ± 5 % reconnectable
3 x 208...520 V AC
- Output voltage: 24 V DC SELV
- Output current: 5...60 A

Page 1.2.8

RECTIFIED POWER SUPPLIES

Single-phase

MEN
INPUT: 115/230 V AC



MEN
INPUT: 115/230 V AC
with DIN-rail adapter

Approvals:

Circuit diagram

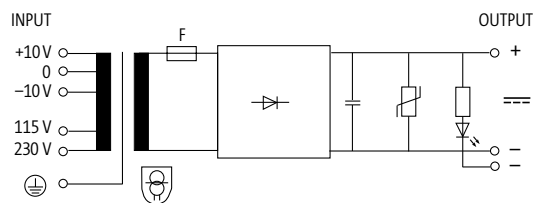

Order Data	H×W×D/kg	Art-No.	H×W×D/kg	Art-No.
24 V DC/1 A	64×78×120/1.3	85360	64×78×120/1.3	8985360
24 V DC/2.5 A	83×84×124/2.1	85361	83×84×124/2.1	8985361
24 V DC/5 A	95×96×136/3.0	85362	95×96×136/3.0	8985362
24 V DC/7.5 A	103×105×151/5.6	85363		

Accessories	Art-No.
Automotive fuses FKS (3 A)	90401
Automotive fuses FKS (5 A)	90403
Automotive fuses FKS (10 A)	90405
Automotive fuses FKS (15 A)	90406

Input		
Input voltage	115/230 V AC ±10 V AC	
Frequency	50/60 Hz	
Output		
Output voltage	24 V DC (SELV)	
Ripple	max. 5 % rms	
Output filter	LED, VDR and smoothing capacitor	
General data		
Standards	(EN 61558-2-6), (EN 62041 category I), (EN 55011 B), (EN 61000-3-2)	
Temperature range	-20...+60 °C, no condensation	
Mounting method	Key-hole mounting	DIN-rail mountable TH35-15 (EN 60715) or for key-hole mounting

Dimension drawing

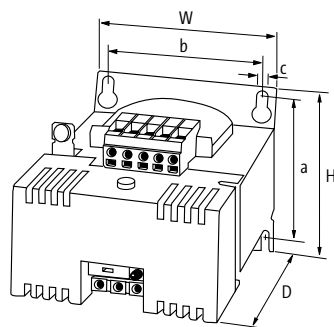

Murrelektronik Online Shop
onlineshop.murrelektronik.com/en

Notes

RECTIFIED POWER SUPPLIES

Single-phase

MEN

INPUT: 115/230 V AC



Approvals:  

Circuit diagram

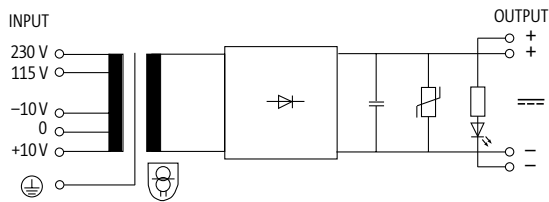

Order Data	HxWxD/kg	Art-No.
24 V DC/10 A	113x120x160/6.0	85364
24 V DC/15 A	139x135x182/8.2	85355
24 V DC/20 A	127x174x214/12.8	85356

Accessories	Art-No.
Automotive fuses FKS (20 A)	90407

Input	
Input voltage	115/230 V AC \pm 10 V AC
Frequency	50/60 Hz

Output	
Output voltage	24 V DC (SELV)
Ripple	max. 5 % rms
Output filter	LED, VDR and smoothing capacitor

General data	
Standards	(EN 61558-2-6), (EN 62041 category I), (EN 55011 B), (EN 61000-3-2)
Temperature range	-20...+60 °C, no condensation
Mounting method	Key-hole mounting

Dimension drawing

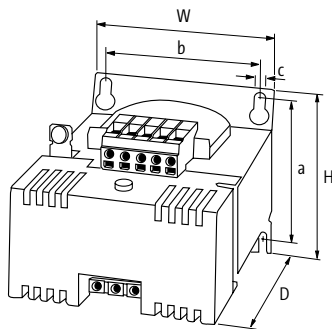

Murrelektronik Online Shop
onlineshop.murrelektronik.com/en

Notes

RECTIFIED POWER SUPPLIES

1-/2-phase

MEN
INPUT: 230/400 V AC

MEN
INPUT: 230/400 V AC
with DIN-rail adapter



Approvals:

Circuit diagram

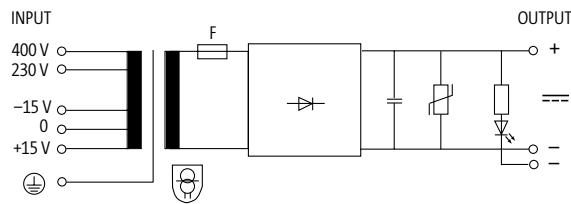

Order Data	H×W×D / kg	Art-No.	H×W×D / kg	Art-No.
24 V DC / 1 A	64×78×120 / 1.3	85349	64×78×120 / 1.3	8985349
24 V DC / 2.5 A	83×84×124 / 2.1	85350	83×84×124 / 2.1	8985350
24 V DC / 5 A	95×96×136 / 3.0	85351	95×96×136 / 3.0	8985351
24 V DC / 7.5 A	103×105×151 / 5.6	85357		

Accessories	Art-No.
Automotive fuses FKS (3 A)	90401
Automotive fuses FKS (5 A)	90403
Automotive fuses FKS (10 A)	90405
Automotive fuses FKS (15 A)	90406

Input	
Input voltage	230/400 ±15 V AC
Frequency	50/60 Hz
Output	
Output voltage	24 V DC (SELV)
Ripple	max. 5 % rms
Output filter	LED, VDR and smoothing capacitor
General data	
Standards	(EN 61558-2-6), (EN 62041 category I), (EN 55011 B), (EN 61000-3-2)
Temperature range	-20...+60 °C, no condensation
Mounting method	Key-hole mounting DIN-rail mountable TH35-15 (EN 60715) or for key-hole mounting

Dimension drawing

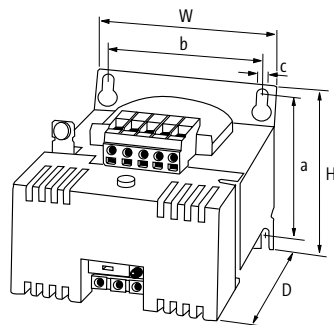

Murrelektronik Online Shop
onlineshop.murrelektronik.com/en

Notes

RECTIFIED POWER SUPPLIES

1-/2-phase

MEN

INPUT: 230/400 V AC



Approvals:  

Circuit diagram

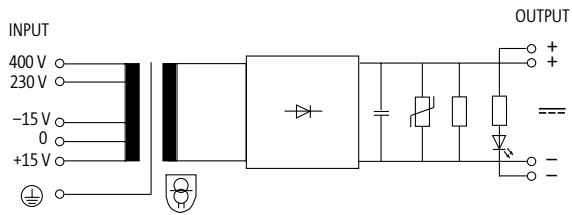

Order Data	HxWxD/kg	Art-No.
24 V DC/10 A	113x120x160/6.0	85352
24 V DC/15 A	139x135x182/8.2	85353
24 V DC/20 A	127x174x214/12.8	85354

Accessories	Art-No.
Automotive fuses FKS (20 A)	90407

Input	
Input voltage	230/400 ±15 V AC
Frequency	50/60 Hz

Output	
Output voltage	24 V DC (SELV)
Ripple	max. 5 % rms
Output filter	LED, VDR and smoothing capacitor

General data	
Standards	(EN 61558-2-6), (EN 62041 category I), (EN 55011 B), (EN 61000-3-2)
Temperature range	-20...+60 °C, no condensation
Mounting method	Key-hole mounting

Dimension drawing

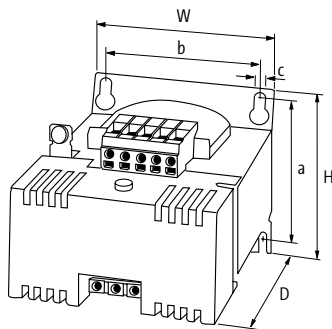

Murrelektronik Online Shop
onlineshop.murrelektronik.com/en

Notes

RECTIFIED POWER SUPPLIES

1-/2-phase

MTPS

INPUT: 230/400 V AC



Circuit diagram

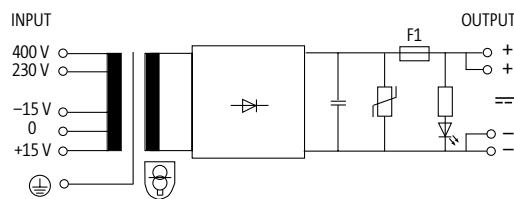

Order Data	HxWxD/kg	Art-No.
24 V DC/0.5 A	108x87x124/1.3	85400
24 V DC/1 A	108x87x124/1.3	85401
24 V DC/2 A	108x87x142/2.0	85402
24 V DC/4 A	108x87x165/2.9	85403

Accessories	Art-No.
Glass automotive fuse 0.5 A (T)	89650
Label plates for MTL/MTPS	89661
Glass automotive fuse 1 A (T)	89651
Glass automotive fuse 2 A (T)	89652
Glass automotive fuse 4 A (T)	89653

Input	
Input voltage	230/400 ±15 V AC
Frequency	50/60 Hz
LED display	LED (green) for input voltage

Output	
Output voltage	24 V DC (SELV)
Ripple	max. 5 % rms
Output filter	LED, VDR and smoothing capacitor

General data	
Standards	(EN 61558-2-6), (EN 62041 category I), (EN 55011 B), (EN 61000-3-2)
Temperature range	-20...+60 °C, no condensation
Mounting method	DIN-rail mountable TH35-15 (EN 60715) or for key-hole mounting

Dimension drawing

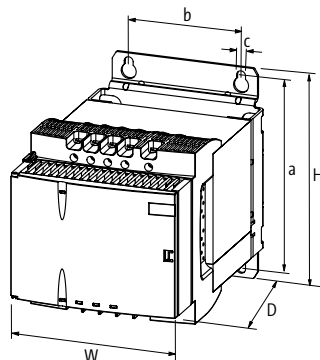

Murrelektronik Online Shop
onlineshop.murrelektronik.com/en

Notes

RECTIFIED POWER SUPPLIES

1-/2-phase

MTPS

INPUT: 230/400 V AC



Approvals:  



Circuit diagram

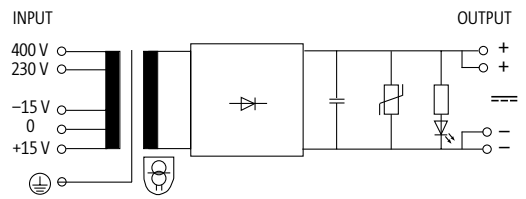
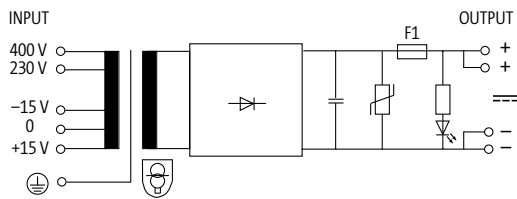

Order Data	HxWxD/kg	Art-No.	HxWxD/kg	Art-No.
24 V DC/6 A	153x123x153/4.9	85404		
24 V DC/10 A			153x123x185/7.7	85405
Accessories				Art-No.
Label plates for MTL/MTPS				89661

Input	
Input voltage	230/400 ±15 V AC
Frequency	50/60 Hz
LED display	LED (green) for input voltage
Output	
Output voltage	24 V DC (SELV)
Ripple	max. 5 % rms
Output filter	LED, VDR and smoothing capacitor
General data	
Standards	(EN 61558-2-6), (EN 62041 category I), (EN 55011 B), (EN 61000-3-2)
Temperature range	-20...+60 °C, no condensation
Mounting method	Key-hole mounting
Dimension drawing	

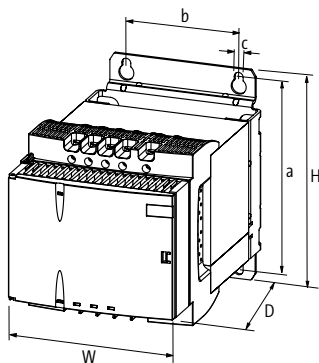

Murrelektronik Online Shop
onlineshop.murrelektronik.com/en

Notes

RECTIFIED POWER SUPPLIES

Single-phase, compact
– stable output voltage

MKN
INPUT: 230 V AC



Approvals:

Circuit diagram

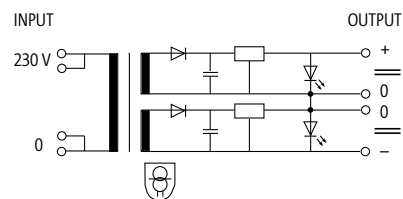
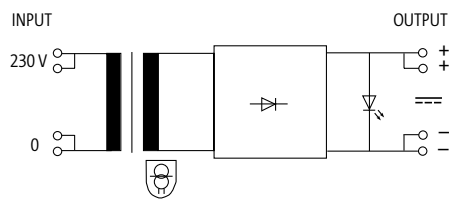

Order Data	Art-No.	Art-No.
24 V DC/70 mA	85610	
10 V DC/80 mA	85615	
5 V DC/200 mA	85620	
9.5...15 V DC/100 mA	85625	
2 × 10 V DC/2 × 50 mA		85616
2 × 15 V DC/2 × 35 mA		85617

Input		
Input voltage	207...253 V AC	
Frequency	50/60 Hz	
Output		
Ripple	max. 10 mV p-p	
Output filter	VDR and smoothing capacitor	LED, VDR and smoothing capacitor
Short-circuit and overload protection	yes	
LED display	LED (green): in operation	
General data		
Standards	(EN 61558-2-6), (EN 62041 category II), (EN 55011 B), (EN 61000-3-2)	
Temperature range	0...+60 °C, no condensation	
Mounting method	DIN-rail mountable TH35 or G32 (EN 60715)	
Dimension drawing		

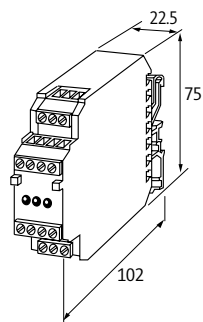

Murrelektronik Online Shop
onlineshop.murrelektronik.com/en

Notes

RECTIFIED POWER SUPPLIES

3-phase

MPL

INPUT: 3 × 400 V AC, ±5% reconnectable



MPL Multi

INPUT: 3 × 208...520 V AC



Approvals:  Listed

Circuit diagram

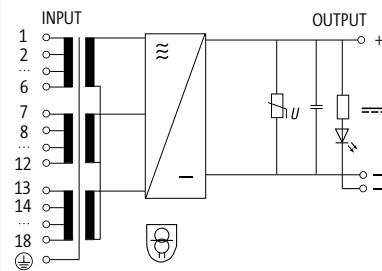
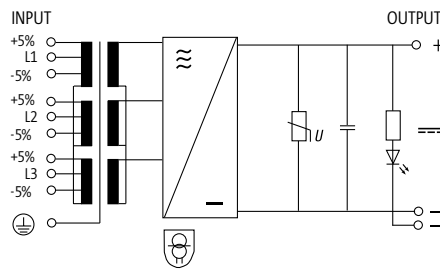

Order Data	H×W×D/kg	Art-No.	H×W×D/kg	Art-No.
24 V DC/5 A	125×73×153/2.9 – cURus	85921		
24 V DC/7.5 A	185×78×188/4.4 – cURus	85923		
24 V DC/10 A	185×78×188/4.5 – cURus	85925	185×93×188/6.6	85953
24 V DC/15 A	220×82×208/8.2 – cURus	85927	220×82×208/7.5	85954
24 V DC/20 A	220×103×213/10.5 – cURus	85929		
24 V DC/25 A	220×103×213/11.0 – cURus	85931	220×103×213/11.1	85955
24 V DC/30 A	240×107×250/13.5 – cURus	85933		
24 V DC/40 A	280×124×313/17.8 – cURus	85935	280×124×313/17.9	85956
24 V DC/50 A	280×134×313/20.9 – cURus	85937	280×134×313/20.9	85957
24 V DC/60 A	280×154×313/26.1 – cURus	85939		

Input

Input voltage	3 × 400 V AC ±5 %	3 × 208...520 V AC
Frequency	50/60 Hz	

Output

Output voltage	24 V DC (SELV)
Ripple	max. 2 % rms
Output filter	LED, VDR and smoothing capacitor

General data

Standards	(EN 61558-2-6), (EN 62041 category I), (EN 55011 B), (EN 61000-3-2)
Temperature range	-20...+55 °C, for any mounting position at vertical wall, no condensation
Mounting method	Key-hole mounting

Dimension drawing

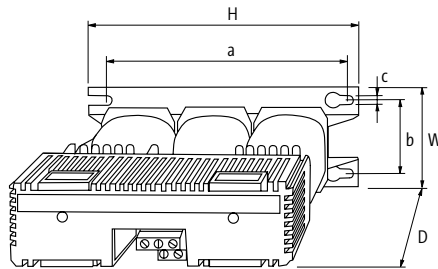

Murrelektronik Online Shop
onlineshop.murrelektronik.com/en

Notes

NOTES

A large grid of small dots for taking notes, consisting of 20 columns and 30 rows.



POWER SUPPLY UNITS

EMPARRO – SIMPLY THE BEST

- Up to 95 % efficiency
- 150 % power boost for 4 seconds
- Cutting edge technology

EMPARRO – THE POWER SUPPLY WITH MAXIMUM EFFICIENCY

- Efficiency up to 95 %
- 150 % power boost for 4 seconds
- Metal housing with optimum EMC characteristics
- No derating between -25°C to +60°C
- Very small width
- High mains failure bridging time
- Seven models, the solution for many applications

Emparro Compared to the Competitors

The comparison is based on the same input current: Emparro (left) emits significantly less heat energy than conventional power supply units. The device itself remains cooler which protects the components installed near the unit. This increases their lifetime.



Power Supply Units



Emparro

- Single-phase
- 150 % power boost
- Spring clamp terminals

Page 1.3.1



ECO Rail/ECO Power

- Single-phase
- Full power up to 40 °C ambient temperature
- Screw terminal connection

Page 1.3.3



PICCO

- 16 models
- 12 V or 24 V outputs
- 10 W, 30 W, 60 W oder 100 W

Page 1.3.7



MCS-B

- Single-phase
- Wide voltage input
- Parallel and series operation possible

Page 1.3.9



Evolution67

- Single-phase
- IP67

Page 1.3.13



Evolution/Evolution+

- Two-/three-phase
- Extended temperature range of -25 °C ... +70 °C
- Approvals for applications worldwide

Page 1.3.14

POWER SUPPLY UNITS

Single-phase, primary switched

– short-circuit and overload protected

Emparro

OUTPUT: 24 V DC



Emparro

OUTPUT: 24 V DC



Emparro

OUTPUT: 24 V DC



Order Data	Art-No.	Art-No.	Art-No.
24 V DC/5 A	cURus, cULus	85440	
24 V DC/10 A		cURus, cULus	85441
24 V DC/20 A			85442
Input			
Input voltage	85...265 V AC/90...250 V DC		90...265 V AC/90...250 V DC
Input current	1.3 A (100 V AC); 0.61 A (240 V AC)	2.6 A (100 V AC); 1.1 A (240 V AC)	5.2 A (100 V AC); 2.2 A (240 V AC)
Inrush current after 1 ms	max. 5.5 A (230 V AC)	max. 13 A (230 V AC)	max. 23 A (230 V AC)
Power factor	0.87 (230 V AC)	0.95 (230 V AC)	0.96 (230 V AC)
External fuse	max. 20 A (T)		
Frequency	50/60 Hz		
Output			
Output voltage	24 V DC (SELV), ±1 %; 24...28 V adjustable		
Powerboost	+150 % (min. 4 seg.)		
Constant current	5 A	11.8 A	20 A
Mains failure bridging time	min. 30 ms (230 V AC); 5 A (24 V DC)	min. 30 ms (230 V AC); 10 A (24 V DC)	min. 30 ms (230 V AC); 20 A (24 V DC)
Ripple	max. 50 mV rms		
Spikes	max. 200 mV p-p		
Short-circuit and overload protection	yes		
LED display	LED (green): OK; LED (red): overload, overheating or short-circuit		
Parallel usage/serial usage	max. 5 units/max. 2 units		
General data			
Standards	(EN 60950-1), (EN 61204-3), (EN 55011 B), (EN 61000-3-2)		
Relative humidity	5...95 %, no condensation		
Efficiency	84.7 % (100 V AC); 93.4 % (230 V AC)	94.3 % (230 V AC)	93.8 % (230 V AC)
Temperature range	-25...+60 °C (storage temperature -40...+85 °C)		
Mounting method	DIN-rail mountable TH35 (EN 60715)		
Dimension drawing			
Notes			

POWER SUPPLY UNITS

Single-phase

– short-circuit and overload protected

Approvals:

Eco Rail

OUTPUT: 24 V DC
Current: 1.3 A



Eco Rail

OUTPUT: 24 V DC
Current: 2.5 A

Eco Rail

OUTPUT: 24 V DC
Current: 5 A

Circuit diagram

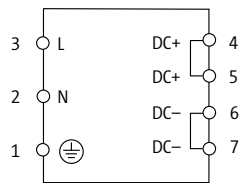

Order Data	H×W×D	Art-No.	H×W×D	Art-No.	H×W×D	Art-No.
24 V DC/1.3 A	125×50×70 mm	85301				
24 V DC/2.5 A			125×50×80 mm	85302		
24 V DC/5 A					125×50×125 mm	85303
Input						
Input voltage	100...240 V AC				90...132 V AC/173...264 V AC	
Input current	0.7 A (115 V AC); 0.4 A (230 V AC)		1.1 A (115 V AC); 0.6 A (230 V AC)		2.3 A (115 V AC); 1.2 A (230 V AC)	
Inrush current after 1 ms	max. 20 A					
External fuse	max. 20 A					
Frequency	50/60 Hz					
Output						
Output voltage	24 V DC ±1 %					
Output current	1.3 A (+40 °C); 1.0 A (+55 °C)		2.5 A (+40 °C); 2.0 A (+55 °C)		5 A (+40 °C); 4 A (+55 °C)	
Mains failure bridging time	min. 25 ms (115 V AC); min. 130 ms (230 V AC)		min. 20 ms (115 V AC); min. 100 ms (230 V AC)		min. 40 ms (115 V AC); min. 40 ms (230 V AC)	
Ripple	max. 20 mV rms					
Short-circuit and overload protection	yes					
Spikes	max. 100 mV p-p				max. 60 mV p-p	
LED display	LED (green) for output voltage					
Parallel usage/serial usage	no/yes (max. 2 units)					
General data						
Standards	(EN 60950-1), (EN 61204-3), (EN 55022 B), (EN 61000-3-2)					
Mounting method	DIN-rail mountable TH35 (EN 60715)					
Efficiency	84 % (115 V AC); 84 % (230 V AC)		85 % (115 V AC); 87 % (230 V AC)		84 % (115 V AC); 86 % (230 V AC)	
Relative humidity	20...90 %, no condensation					
Temperature range	0...+40 °C, to +55 °C derating (storage temperature -20...+85 °C)					

Dimension drawing

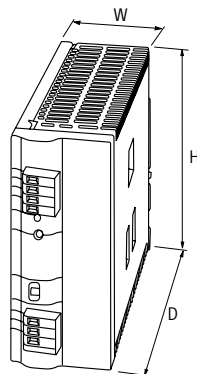

Murrelektronik Online Shop
onlineshop.murrelektronik.com/en

Notes

POWER SUPPLY UNITS

Single-phase

– short-circuit and overload protected

Approvals:  UL US Listed

Eco Rail

OUTPUT: 24 V DC
Current: 10 A



Eco Rail

OUTPUT: 24 V DC
Current: 20 A



Circuit diagram

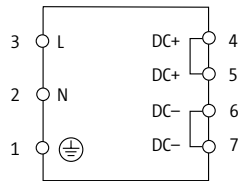

Order Data	HxWxD	Art-No.	HxWxD	Art-No.
24 V DC/10 A	125x72x125 mm	85305		
24 V DC/20 A			125x105x127 mm	85307

Input		
Input voltage	90...132 V AC/173...264 V AC	
Input current	4 A (115 V AC); 2.4 A (230 V AC)	9 A (100 V AC); 4.5 A (200 V AC)
Inrush current after 1 ms	max. 20 A	max. 30 A
External fuse	max. 20 A	
Frequency	50/60 Hz	

Output		
Output voltage	24 V DC $\pm 1\%$	
Output current	10 A (+40 °C); 7.5 A (+55 °C)	20 A (+40 °C); 16 A (+55 °C)
Mains failure bridging time	min. 20 ms (115 V AC); min. 20 ms (230 V AC)	min. 15 ms (115 V AC); min. 30 ms (230 V AC)
Ripple	max. 20 mV rms	
Short-circuit and overload protection	yes	
Spikes	max. 150 mV p-p	max. 100 mV p-p
LED display	LED (green) for output voltage	
Parallel usage/serial usage	no/yes (max. 2 units)	

General data		
Standards	(EN 60950-1), (EN 61204-3), (EN 55022 B)	
Mounting method	DIN-rail mountable TH35 (EN 60715)	
Efficiency	87 % (115 V AC); 88 % (230 V AC)	87 % (115 V AC); 89 % (230 V AC)
Relative humidity	20...90 %, no condensation	
Temperature range	0...+40 °C, to +55 °C derating (storage temperature -20...+85 °C)	

Dimension drawing

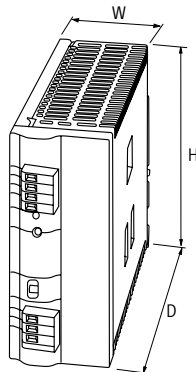

Murrelektronik Online Shop
onlineshop.murrelektronik.com/en

Notes

POWER SUPPLY UNITS

Single-phase

– short-circuit and overload protected

Eco Power

OUTPUT: 24 V DC
Current: 1.3 A



Eco Power

OUTPUT: 24 V DC
Current: 2.5 A

Circuit diagram

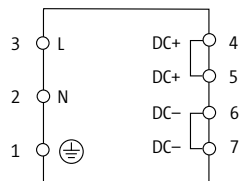

Order Data	H×W×D	Art-No.	H×W×D	Art-No.
24 V DC/1.3 A	36×77×105 mm	85151		
24 V DC/2.5 A			40×98×135 mm	85152
Input				
Input voltage	100...240 V AC			
Input current	0.7 A (115 V AC); 0.4 A (230 V AC)		1.2 A (115 V AC); 0.5 A (230 V AC)	
Inrush current after 1 ms	max. 20 A			
External fuse	max. 16 A			
Frequency	50/60 Hz			
Output				
Output voltage	24 V DC ±1 %			
Output current	1.3 A (+40 °C); 1.04 A (+50 °C)		2.5 A (+40 °C); 2.0 A (+50 °C)	
Mains failure bridging time	min. 10 ms (115 V AC); min. 90 ms (230 V AC)			
Ripple	max. 20 mV rms			
Short-circuit and overload protection	yes			
Spikes	max. 100 mV p-p			
LED display	LED (green) for output voltage			
Parallel usage/serial usage	no/yes (max. 2 units)			
General data				
Standards	(EN 60950-1), (EN 61204-3), (EN 55011 B)			
Mounting method	screw fixing, M3			
Efficiency	85 % (115 V AC); 85 % (230 V AC)		85 % (115 V AC); 87 % (230 V AC)	
Relative humidity	20...90 %, no condensation			
Temperature range	0...+40 °C, to +50 °C derating (storage temperature -20...+85 °C)			

Dimension drawing

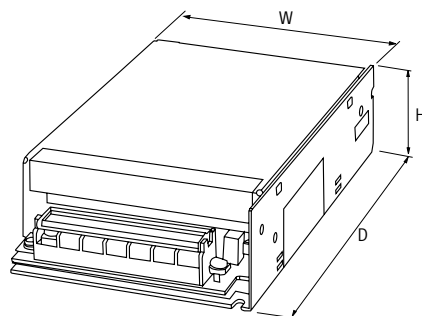

Murrelektronik Online Shop
onlineshop.murrelektronik.com/en

Notes

POWER SUPPLY UNITS

Single-phase

– short-circuit and overload protected

Eco Power

OUTPUT: 24 V DC
Current: 5 A



Eco Power

OUTPUT: 24 V DC
Current: 7.5 A

Eco Power

OUTPUT: 24 V DC
Current: 10 A

Circuit diagram

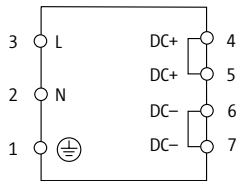

Order Data	H×W×D	Art-No.	H×W×D	Art-No.	H×W×D	Art-No.
24 V DC/5 A	41×98×164 mm	85153				
24 V DC/7.5 A			50×100×205 mm	85154		
24 V DC/10 A					50×115×230 mm	85155

Input						
Input voltage	100...240 V AC		100...120 V AC/200...240 V AC			
Input current	2.4 A (115 V AC); 1.0 A (230 V AC)		3.4 A (115 V AC); 1.9 A (230 V AC)		4.6 A (115 V AC); 2.8 A (230 V AC)	
Inrush current after 1 ms	max. 20 A					
External fuse	max. 16 A					
Frequency	50/60 Hz					
Output						
Output voltage	24 V DC ±1 %					
Output current	5 A (+40 °C); 4 A (+50 °C)		7.5 A (+40 °C); 6.0 A (+50 °C)		10 A (+40 °C); 8 A (+50 °C)	
Mains failure bridging time	min. 15 ms (115 V AC); min. 80 ms (230 V AC)		min. 20 ms (115 V AC); min. 20 ms (230 V AC)		min. 15 ms (115 V AC); min. 15 ms (230 V AC)	
Ripple	max. 30 mV rms		max. 50 mV rms		max. 30 mV rms	
Spikes	max. 100 mV p-p				max. 200 mV p-p	
Short-circuit and overload protection	yes					
LED display	LED (green) for output voltage					
Parallel usage/serial usage	no/yes (max. 2 units)					
General data						
Standards	(EN 60950-1), (EN 61204-3), (EN 55011 B)					
Mounting method	screw fixing, M3				screw fixing, M4	
Efficiency	86 % (115 V AC); 87 % (230 V AC)		85 % (115 V AC); 86 % (230 V AC)		84 % (115 V AC); 85 % (230 V AC)	
Relative humidity	20...90 %, no condensation					
Temperature range	0...+40 °C, to +50 °C derating (storage temperature -20...+85 °C)					

Dimension drawing

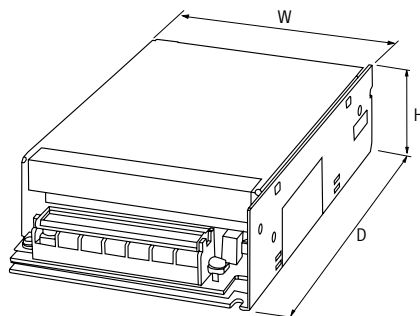

Murrelektronik Online Shop
onlineshop.murrelektronik.com/en

Notes

POWER SUPPLY UNITS

Single-phase

– short-circuit and overload protected

Approvals: cUL US Listed

Picco

OUTPUT: 24 V DC \pm 1%
Current: 0.42 A



Picco

OUTPUT: 24 V DC \pm 1%
Current: 1.25 A



Picco

OUTPUT: 24 V DC \pm 1%
Current: 2.5 A



Picco

OUTPUT: 24 V DC \pm 1%
Current: 4.2 A



Circuit diagram

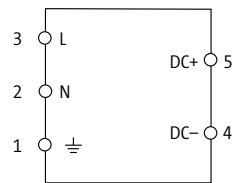

Order Data	Art-No.	Art-No.	Art-No.	Art-No.
Screw terminals	24 V DC/0.42 A 87011	24 V DC/1.25 A 87013	24 V DC/2.5 A 87015	24 V DC/4.2 A 87017
Spring clamp plug-in terminals	24 V DC/0.42 A 87111	24 V DC/1.25 A 87113	24 V DC/2.5 A 87115	24 V DC/4.2 A 87117
Input				
Input voltage	100...240 V AC; 120...370 V DC			
Input current	0.2 A (115 V AC); 0.12 A (230 V AC)	0.6 A (115 V AC); 0.4 A (230 V AC)	1.1 A (115 V AC); 0.6 A (230 V AC)	1.7 A (115 V AC); 1 A (230 V AC)
Inrush current after 1 ms	max. 30 A	max. 40 A	max. 60 A	
External fuse	max. 10 A		max. 16 A	max. 10 A
Frequency	50/60 Hz			
Output				
Output voltage	24 V DC (SELV), \pm 1%; 24...28 V adjustable			
Output current	0.42 A (+50 °C); 0.042 A (+70 °C)	1.25 A (+50 °C); 0.125 A (+70 °C)	2.5 A (+50 °C); 0.25 A (+70 °C)	4.2 A (+50 °C); 0.42 A (+70 °C)
Mains failure bridging time	10...25 ms (115 V AC)			
Ripple	max. 20 mV rms			
Short-circuit and overload protection	yes			
Spikes	max. 100 mV p-p			
LED display	LED (green) for output voltage			
Parallel usage/serial usage	max. 5 units/max. 2 units			
General data				
Standards	(EN 60950-1), (EN 61204-3), (EN 55022 B), (EN 61000-3-2)			
Relative humidity	20...90 %, no condensation			
Efficiency	79 % (110 V AC); 80 % (230 V AC)	86 % (110 V AC); 88 % (230 V AC)		
Temperature range	0...+50 °C, to +70 °C derating (storage temperature -25...+70 °C)			
Mounting method	DIN-rail mountable TH35 (EN 60715)			

Dimension drawing

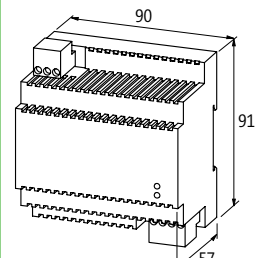
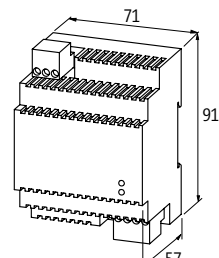
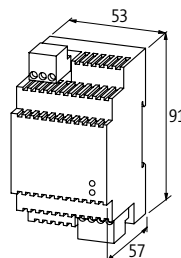
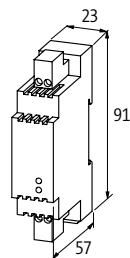

Murrelektronik Online Shop
onlineshop.murrelektronik.com/en

Notes

POWER SUPPLY UNITS

Single-phase

– short-circuit and overload protected

Picco

OUTPUT: 12 V DC \pm 1%
Current: 0.85 A



Picco

OUTPUT: 12 V DC \pm 1%
Current: 2.5 A



Picco

OUTPUT: 12 V DC \pm 1%
Current: 4.5 A



Picco

OUTPUT: 12 V DC \pm 1%
Current: 6 A



Approvals:

Circuit diagram

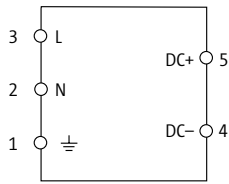

Order Data	Art-No.	Art-No.	Art-No.	Art-No.
Screw terminals	12 V DC/0.85 A 87012	12 V DC/2.5 A 87014	12 V DC/4.5 A 87016	12 V DC/6 A 87018
Spring clamp plug-in terminals	12 V DC/0.85 A 87112	12 V DC/2.5 A 87114	12 V DC/4.5 A 87116	12 V DC/6 A 87118

Input				
Input voltage	100...240 V AC; 120...370 V DC			
Input current	0.2 A (115 V AC); 0.12 A (230 V AC)	0.6 A (115 V AC); 0.4 A (230 V AC)	1 A (115 V AC); 0.58 A (230 V AC)	1.3 A (115 V AC); 0.75 A (230 V AC)
Inrush current after 1 ms	max. 30 A	max. 40 A	max. 60 A	
External fuse	max. 10 A		max. 16 A	max. 10 A
Frequency	50/60 Hz			
Output				
Output voltage	12 V DC (SELV), \pm 1 %; 12...15 V adjustable			
Output current	0.85 A (+50 °C); 0.085 A (+70 °C)	2.5 A (+50 °C); 0.25 A (+70 °C)	4.5 A (+50 °C); 0.45 A (+70 °C)	6 A (+50 °C); 0.6 A (+70 °C)
Mains failure bridging time	10...25 ms (115 V AC)			
Ripple	max. 20 mV rms			
Short-circuit and overload protection	yes			
Spikes	max. 100 mV p-p			
LED display	LED (green) for output voltage			
Parallel usage/serial usage	max. 5 units/max. 2 units			
General data				
Standards	(EN 60950-1), (EN 61204-3), (EN 55022 B), (EN 61000-3-2)			
Relative humidity	20...90 %, no condensation			
Efficiency	86 % (110 V AC); 88 % (230 V AC)			
Temperature range	0...+50 °C, to +70 °C derating (storage temperature -25...+70 °C)			
Mounting method	DIN-rail mountable TH35 (EN 60715)			

Dimension drawing

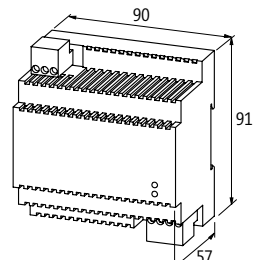
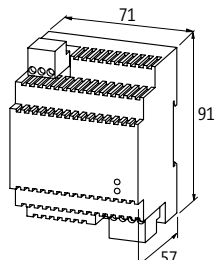
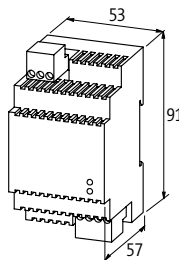
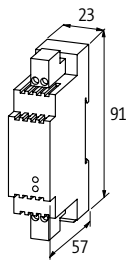

Murrelektronik Online Shop
onlineshop.murrelektronik.com/en

Notes

POWER SUPPLY UNITS

Single-phase, primary switched

– stable output voltage,
(short-circuit and overload
protected)

Approvals:  

MCS-B

OUTPUT: 24 V DC \pm 1%
Current: 0.6 A



MCS-B

OUTPUT: 24 V DC \pm 1%
Current: 1.3 A

MCS-B

OUTPUT: 24 V DC \pm 1%
Current: 2.5 A



Circuit diagram

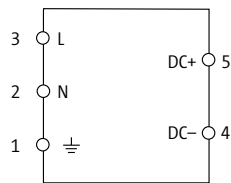

Order Data	H×W×D/kg	Art-No.	H×W×D/kg	Art-No.	H×W×D/kg	Art-No.
24 V DC/0.6 A	76×38×80/0.1	85160				
24 V DC/1.3 A			76×38×80/0.1	85161		
24 V DC/2.5 A					76×38×101/0.2	85162
Input						
Input voltage	90...265 V AC; 110...300 V DC			95...265 V AC; 110...300 V DC		
Input current	0.3 A (+50 °C); 0.2 A (+60 °C)		0.65 A (100 V AC); 0.37 A (230 V AC)		1.04 A (110 V AC); 0.63 A (230 V AC)	
Inrush current after 1 ms	max. 20 A					
External fuse	max. 10 A					
Frequency	50/60 Hz					
Output						
Output voltage	24 V DC (SELV), \pm 1 %; 22...28 V adjustable					
Output current	0.6 A (+50 °C); 0.5 A (+60 °C)		1.3 A (+60 °C, U _{in} min.170 V AC)		2.5 A (+40 °C); 2.0 A (+55 °C)	
Mains failure bridging time	min. 25 ms (100 V AC); min. 150 ms (230 V AC)		min. 15 ms (100 V AC); min. 100 ms (230 V AC)		min. 15 ms (110 V AC); min. 80 ms (230 V AC)	
Ripple	max. 50 mV rms					
Spikes	max. 350 mV p-p		max. 120 mV p-p			
Short-circuit and overload protection	yes					
LED display	LED (green) for output voltage					
Parallel usage/serial usage	max. 5 units/max. 2 units					
General data						
Standards	(EN 60950-1), (EN 61204-3), (EN 55022 B), (EN 61000-3-2)					
Relative humidity	5...95 %, no condensation					
Efficiency	81 % (100 V AC); 83 % (230 V AC)		82 %		85 % (110 V AC); 87 % (230 V AC)	
Temperature range	0...+50 °C, to +70 °C derating (storage temperature -25...+85 °C)		0...+40 °C, to +70 °C derating (storage temperature -25...+85 °C)			
Mounting method	DIN-rail mountable TH35 (EN 60715)					

Dimension drawing

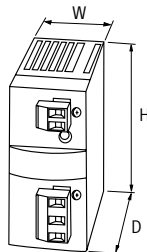

Murrelektronik Online Shop
onlineshop.murrelektronik.com/en

Notes

POWER SUPPLY UNITS

Single-phase, primary switched

– stable output voltage,
(short-circuit and overload
protected)

MCS-B

OUTPUT: 5 V DC \pm 1%
Current: 3 A



MCS-B

OUTPUT: 12 V DC \pm 1%
Current: 1 A

Circuit diagram

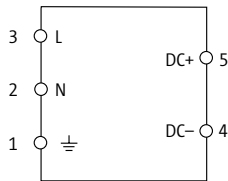

Order Data	HxWxD/kg	Art-No.	HxWxD/kg	Art-No.
5 V DC/3 A	76x38x80/0.1	85371		
12 V DC/1 A			76x38x80/0.1	85372
Input				
Input voltage	95...265 V AC; 110...300 V DC		90...265 V AC; 110...300 V DC	
Input current	0.3 A (115 V AC); 0.2 A (230 V AC)		0.29 A (115 V AC); 0.16 A (230 V AC)	
Inrush current after 1 ms	max. 15 A		max. 20 A	
External fuse	max. 10 A			
Frequency	50/60 Hz			
Output				
Output voltage	5 V DC (SELV), \pm 1 %; 4.2...6 V adjustable		12 V DC (SELV), \pm 1 %; 12...15 V adjustable	
Output current	3 A (+40 °C); 2.5 A (+55 °C)		1 A (+50 °C); 0.8 A (+60 °C)	
Mains failure bridging time	min. 30 ms (115 V AC); min. 180 ms (230 V AC)		min. 20 ms (115 V AC); min. 150 ms (230 V AC)	
Ripple	max. 20 mV rms		max. 50 mV rms	
Spikes	max. 120 mV p-p		max. 300 mV p-p	
Short-circuit and overload protection	yes			
LED display	LED (green) for output voltage			
Parallel usage/serial usage	no/yes (max. 2 units)			
General data				
Standards	(EN 60950-1), (EN 61204-3), (EN 55022 B), (EN 61000-3-2)			
Relative humidity	5...95 %, no condensation			
Efficiency	80 %		77 %	
Temperature range	0...+40 °C, to +55 °C derating (storage temperature -25...+85 °C)		0...+50 °C, to +60 °C derating (storage temperature -25...+85 °C)	
Mounting method	DIN-rail mountable TH35 (EN 60715)			
Dimension drawing				

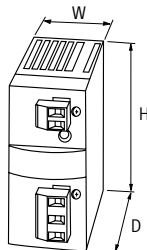

Murrelektronik Online Shop
onlineshop.murrelektronik.com/en

Notes

POWER SUPPLY UNITS

Single-phase, primary switched

– stable output voltage,
(short-circuit and overload
protected)

MCS-B

OUTPUT: 12 V DC \pm 1%
Current: 2.5 A



MCS-B

OUTPUT: 24 V DC \pm 1%
Current: 5 A



Circuit diagram

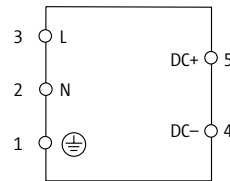
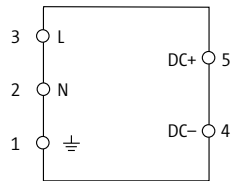

Order Data	H×W×D/kg	Art-No.	H×W×D/kg	Art-No.
12 V DC/2.5 A	76×38×80/0.2	85373		
24 V DC/5 A			115×54×125/0.5 – cULus, cURus, GL	85163
Accessories			Accessories	
Mounting plate 40 mm				89851
Input			Input	
Input voltage	95...265 V AC; 110...300 V DC		100...265 V AC	
Input current	0.56 A (115 V AC); 0.31 A (230 V AC)		2 A (110 V AC); 1.16 A (230 V AC)	
Inrush current after 1 ms	max. 20 A		max. 30 A	
External fuse	max. 10 A			
Frequency	50/60 Hz			
Output			Output	
Output voltage	12 V DC (SELV), \pm 1%; 12...15 V adjustable		24 V DC (SELV), \pm 1%; 22...28 V adjustable	
Output current	2.5 A (+40 °C); 2.1 A (+55 °C)		5 A (+40 °C); 4 A (+55 °C)	
Mains failure bridging time	min. 20 ms (115 V AC); min. 110 ms (230 V AC)		min. 10 ms (110 V AC); min. 80 ms (230 V AC)	
Ripple	max. 50 mV rms		max. 20 mV rms	
Spikes	max. 120 mV p-p		max. 100 mV p-p	
Short-circuit and overload protection	yes			
LED display	LED (green) for output voltage			
Parallel usage/serial usage	no/yes (max. 2 units)		max. 5 units/max. 2 units	
General data			General data	
Standards	(EN 60950-1), (EN 61204-3), (EN 55022 B), (EN 61000-3-2)		(EN 60950-1), (EN 61204-3), (EN 55011 A)	
Relative humidity	5...95 %, no condensation			
Efficiency	82 %		86 % (115 V AC); 87 % (230 V AC)	
Temperature range	0...+40 °C, to +55 °C derating (storage temperature -25...+85 °C)		0...+40 °C, to +70 °C derating (storage temperature -25...+85 °C)	
Mounting method	DIN-rail mountable TH35 (EN 60715)			

Dimension drawing

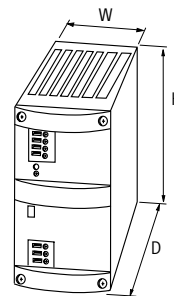
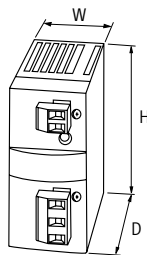

Murrelektronik Online Shop
onlineshop.murrelektronik.com/en

Notes

POWER SUPPLY UNITS

Single-phase, primary switched

– stable output voltage,
(short-circuit and overload
protected)

Approvals:  Listed

MCS-B

OUTPUT: 24 V DC \pm 1%
Current: 7.5 A



MCS-B

OUTPUT: 24 V DC \pm 1%
Current: 10 A



Circuit diagram

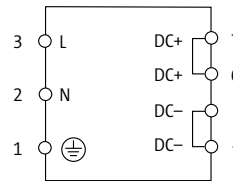
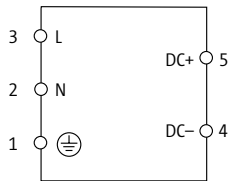

Order Data	HxWxD/kg	Art-No.	HxWxD/kg	Art-No.
24 V DC/7.5 A	115x54x145/0.7	85164		
24 V DC/10 A			128x68x165/0.8 – cURus, GL	85165
Accessories				Art-No.
Screw mounting set				89514
Input				
Input voltage	100...265 V AC			
Input current	2.9 A (115 V AC); 1.6 A (230 V AC)		3.4 A (115 V AC); 2.2 A (230 V AC)	
Inrush current after 1 ms	max. 37 A		max. 40 A	
External fuse	max. 10 A		max. 16 A	
Frequency	50/60 Hz			
Output				
Output voltage	24 V DC (SELV), \pm 1%; 22...28 V adjustable			
Output current	7.5 A (+40 °C), 6 A (+55 °C)		10 A (+40 °C); 8 A (+55 °C)	
Mains failure bridging time	min. 14 ms (115 V AC); min. 80 ms (230 V AC)		min. 15 ms (115 V AC); min. 115 ms (230 V AC)	
Ripple	max. 20 mV rms			
Spikes	max. 100 mV p-p			
Short-circuit and overload protection	yes			
LED display	LED (green) for output voltage			
Parallel usage/serial usage	max. 5 units/max. 2 units			
General data				
Standards	(EN 60950-1), (EN 61204-3), (EN 55011 A)			
Relative humidity	5...95 %, no condensation			
Efficiency	87 %		83 % (115 V AC); 85 % (230 V AC)	
Temperature range	0...+40 °C, to +70 °C derating (storage temperature -25...+85 °C)			
Mounting method	DIN-rail mountable TH35 (EN 60715)			
Dimension drawing				

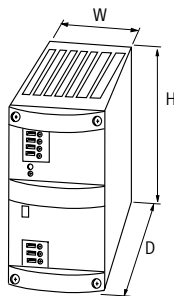

Murrelektronik Online Shop
onlineshop.murrelektronik.com/en

Notes

POWER SUPPLY UNITS

Single-phase, primary switched

– stable output voltage,
(short-circuit and overload
protected)

Approvals:  

MCS

OUTPUT: 12 V DC \pm 1%
Current: 5 A



MCS

OUTPUT: 5 V DC \pm 1%
Current: 6 A

Circuit diagram

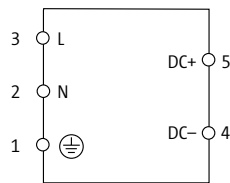

Order Data	H×W×D/kg	Art-No.	H×W×D/kg	Art-No.
12 V DC/5 A	108×42×98/0.4	85040		
5 V DC/6 A			108×42×98/0.4	85041
Input				
Input voltage	90...265 V AC; 110...300 V DC		100...240 V AC	
Input current	1.1 A (115 V AC); 0.6 A (230 V AC)		0.5 A (115 V AC); 0.3 A (230 V AC)	
Inrush current after 1 ms	max. 28 A		max. 22 A	
External fuse	max. 10 A			
Frequency	50/60 Hz			
Output				
Output voltage	12 V DC (SELV), \pm 1 %; 10...15 V adjustable		5 V DC (SELV), \pm 1 %, 4...6 V adjustable	
Output current	5 A (+55 °C); 6 A (+45 °C)		6 A (+60 °C); 7.5 A (+50 °C)	
Mains failure bridging time	min. 10 ms (115 V AC); min. 70 ms (230 V AC)		min. 12 ms (115 V AC); min. 90 ms (230 V AC)	
Ripple	max. 20 mV rms		max. 10 mV rms	
Spikes	max. 200 mV p-p		max. 50 mV p-p	
Short-circuit and overload protection	yes			
LED display	LED (green) for output voltage			
Parallel usage/serial usage	no/yes (max. 2 units)			
General data				
Standards	(EN 60950-1), (EN 61204-3), (EN 55022 B), (EN 61000-3-2)			
Relative humidity	5...95 %, no condensation			
Efficiency	85 %		80 %	
Temperature range	0...+55 °C (storage temperature -25...+85 °C)		0...+60 °C (storage temperature -25...+85 °C)	
Mounting method	DIN-rail mountable TH35 (EN 60715)			

Dimension drawing

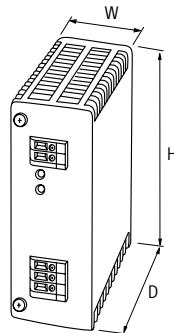

Murrelektronik Online Shop
onlineshop.murrelektronik.com/en

Notes

POWER SUPPLY UNITS

Single-phase, primary switched

– stable output voltage,
(short-circuit and overload
protected)

Evolution67

OUTPUT: 24 V DC \pm 2%
Current: 3.8 A



Evolution67

OUTPUT: 24 V DC \pm 2%
Current: 8 A



Evolution67

OUTPUT: 24 V DC
Current 2 \times 3.8 A galvanically separated



Power Supply Units

Order Data	Art-No.		Art-No.
24 V DC/3.8 A	85673		
24 V DC/8 A			85674
24 V DC/2 \times 3.8 A			85675
Input			
Input voltage	100...240 V AC	90...264 V DC	100...240 V AC
Input current	2 A (115 V AC); 1 A (240 V AC)	2.4 A (115 V AC); 1.2 A (230 V AC)	2 A (115 V AC); 1 A (230 V AC)
External fuse	max. 10 A (C)		
Inrush current after 1 ms	–	max. 9 A	
Frequency	50/60 Hz		
Output			
Output voltage	24 V DC (SELV), \pm 2 %		
Output current	3.8 A (+50 °C); 2.3 A (+70 °C)	8 A (+60 °C); 6.4 A (+70 °C)	2 \times 3.8 A (+50 °C); 2 \times 2.3 A (+70 °C)
Mains failure bridging time	min. 50 ms (230 V AC); 3.8 A (24 V DC)	min. 50 ms (230 V AC); 8 A (24 V DC)	min. 50 ms (230 V AC); 3.8 A (24 V DC)
Powerboost	–	+150 % (min. 4 seg.)	–
Ripple	max. 1 %		
Spikes	max. 240 mV p-p		
LED display	LED (green): OK		
General data			
Standards	(EN 60950-1), (EN 61204-3), (EN 55011 A), (EN 61000-3-2)		
Relative humidity	5...95 %, no condensation		
Protection	IP67 inserted and tightened (EN 60529)		
Efficiency	90 %	89 %	
Temperature range	-25...+70 °C (storage temperature -40...+85 °C)	-25...+60 °C (storage temperature -40...+85 °C)	-25...+70 °C (storage temperature -40...+85 °C)
Connection	IN: M12, C-coded; OUT: 7/8"		
Mounting method	screw fixing, M5		
Dimension drawing			

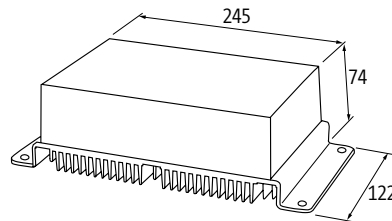
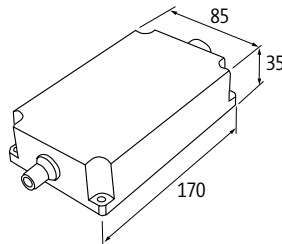

Murrelektronik Online Shop
onlineshop.murrelektronik.com/en

Notes

POWER SUPPLY UNITS

2-/3-phase

– stable output voltage,
(short-circuit and overload
protected)

Approvals:

Evolution

OUTPUT: 24 V DC \pm 1%
Current: 5 A



Evolution

OUTPUT: 24 V DC \pm 1%
Current: 10 A



Evolution

OUTPUT: 24 V DC \pm 1%
Current: 20 A



Evolution

OUTPUT: 24 V DC \pm 1%
Current: 40 A



Circuit diagram

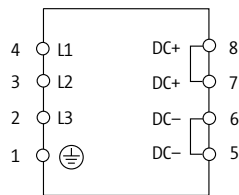

Order Data	HxWxD/kg	Art-No.	HxWxD/kg	Art-No.	HxWxD/kg	Art-No.	HxWxD/kg	Art-No.
24 V DC/5 A	132x83x98/1.0	85000						
24 V DC/10 A			132x93x114/1.3	85001				
24 V DC/20 A					132x113x136/2.0	85002		
24 V DC/40 A							132x164x142/3.0	85004

Input	
Input voltage	3 x 324...572 V AC/480...745 V DC
Input current	3 x 0.3 A 3 x 0.8 A 3 x 1.3 A 3 x 2.4 A
Inrush current after 1 ms	max. 10 A max. 15 A max. 19 A –
External fuse	max. 3 x 10 A max. 3 x 20 A
Frequency	50/60 Hz
Output	
Output voltage	24 V DC (SELV), \pm 1%; 22...28 V adjustable
Output current	5 A (+55 °C); 3 A (+70 °C) 10 A (+55 °C); 6.5 A (+70 °C) 20 A (+55 °C); 15.8 A (+70 °C) 40 A (+55 °C); 30 A (+70 °C)
Powerboost	+150 % (min. 4 seg.)
Mains failure bridging time	min. 30 ms (400 V AC) min. 19 ms (400 V AC)
Ripple	max. 50 mV rms
Spikes	max. 100 mV p-p
LED display	LED (green): OK; LED (red): overload
Parallel usage/serial usage	max. 5 units/max. 2 units
General data	
Standards	(EN 60950-1), (EN 61204-3), (EN 55022 B), (EN 61000-3-2) (EN 60950-1), (EN 61204-3), (EN 55011 A)
Temperature range	-25...+70 °C (storage temperature -40...+85 °C)
Relative humidity	5...95 %, no condensation
Efficiency	86 % 90 %
Mounting method	DIN-rail mountable TH35 (EN 60715)
Protection	IP20

Dimension drawing

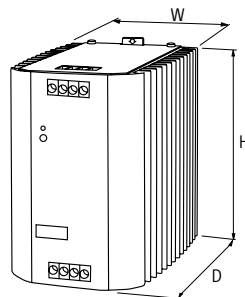

Murrelektronik Online Shop
onlineshop.murrelektronik.com/en

Notes

POWER SUPPLY UNITS

2-/3-phase

– stable output voltage,
(short-circuit and overload
protected)

Approvals:  

Evolution+

OUTPUT: 24 V DC \pm 1%
Current: 5 A



Evolution+

OUTPUT: 24 V DC \pm 1%
Current: 10 A



Evolution+

OUTPUT: 24 V DC \pm 1%
Current: 20 A



Evolution+

OUTPUT: 24 V DC \pm 1%
Current: 40 A



Circuit diagram

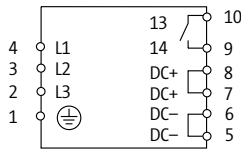

Order Data	HxWxD/kg	Art-No.	HxWxD/kg	Art-No.	HxWxD/kg	Art-No.	HxWxD/kg	Art-No.
24 V DC/5 A	132x83x98/1.0	85640						
24 V DC/10 A			132x93x114/1.2	85641				
24 V DC/20 A					132x113x136/2.0	85642		
24 V DC/40 A							132x164x142/3.0	85644

Input

Input voltage	3 x 324...572 V AC/480...745 V DC			
Input current	3 x 0.45 A	3 x 0.8 A	3 x 1.3 A	3 x 2.4 A
Inrush current after 1 ms	max. 10 A	max. 15 A	max. 19 A	–
External fuse	max. 3 x 10 A		max. 3 x 20 A	
Frequency	50/60 Hz			

Output

Output voltage	24 V DC (SELV), \pm 1 %; 22...28 V adjustable			
Output current	5 A (+55 °C); 3 A (+70 °C)	10 A (+55 °C); 6.5 A (+70 °C)	20 A (+55 °C); 15.8 A (+70 °C)	40 A (+55 °C); 30 A (+70 °C)
Powerboost	+150 % (min. 4 seg.)			
Mains failure bridging time	min. 30 ms (400 V AC)		min. 19 ms (400 V AC)	
Ripple	max. 50 mV rms			
Spikes	max. 100 mV p-p			
LED display	LED (green): OK; LED (red): overload			
Parallel usage/serial usage	max. 5 units/max. 2 units			
Alarm output	electronic relay max. 30 V DC/0.1 A, group alarm			

General data

Standards	(EN 60950-1), (EN 61204-3), (EN 55022 B), (EN 61000-3-2)		(EN 60950-1), (EN 61204-3), (EN 55011 A)	
Temperature range	-25...+70 °C (storage temperature -40...+85 °C)			
Relative humidity	5...95 %, no condensation			
Protection	Circuit board with protective varnish			
Efficiency	86 %	90 %		
Mounting method	DIN-rail mountable TH35 (EN 60715)			
Protection	IP20			

Dimension drawing

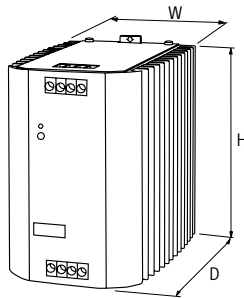

Murrelektronik Online Shop
onlineshop.murrelektronik.com/en

Notes

POWER SUPPLY UNITS

2-/3-phase

– stable output voltage,
(short-circuit and overload
protected)

Evolution

OUTPUT: 12 V DC \pm 1%
Current: 20 A



Evolution+

OUTPUT: 48 V DC
Current: 5 A



Evolution+

OUTPUT: 48 V DC
Current: 10 A



Evolution+

OUTPUT: 48 V DC
Current: 20 A



Circuit diagram

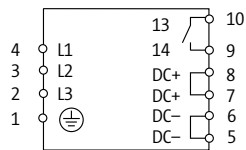

Order Data	HxWxD/kg	Art-No.	HxWxD/kg	Art-No.	HxWxD/kg	Art-No.	HxWxD/kg	Art-No.
12 V DC/20 A	132x93x114/1.3	85016						
48 V DC/5 A			132x93x114/1.4	85009				
48 V DC/10 A					132x113x136/2.0	85010		
48 V DC/20 A							132x164x142/3.0	85011

Input	
Input voltage	3 x 324...572 V AC/480...745 V DC
Input current	3 x 0.8 A
Inrush current after 1 ms	max. 15 A
External fuse	max. 3 x 10 A
Frequency	50/60 Hz
Output	
Output voltage	12 V DC (SELV), \pm 1 %; 12...13.5 V adjustable
Output current	20 A (+55 °C); 15.8 A (+70 °C)
Powerboost	+150 % (min. 4 seg.)
Mains failure bridging time	min. 19 ms (400 V AC)
Ripple	max. 50 mV rms
Spikes	max. 100 mV p-p
LED display	LED (green): OK; LED (red): overload
Parallel usage/serial usage	max. 5 units/max. 4 units
Alarm output	electronic relay max. 30 V DC/0.1 A, group alarm
General data	
Standards	(EN 60950-1), (EN 61204-3), (EN 55022 B), (EN 61000-3-2)
Temperature range	-25...+70 °C (storage temperature -40...+85 °C)
Relative humidity	5...95 %, no condensation
Efficiency	90 %
Protection	–
Mounting method	DIN-rail mountable TH35 (EN 60715)
Protection	IP20

Dimension drawing

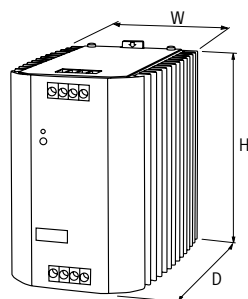

Murrelektronik Online Shop
onlineshop.murrelektronik.com/en

Notes

POWER SUPPLY UNITS

Single-phase

– AS-Interface

MCS-A 4

OUTPUT: 30.5 V DC
Current: 4 A



MCS-A 4 EFD

OUTPUT: 30.5 V DC
Current: 4 A
with EFD (earth fault detection)



Approvals: 

Circuit diagram

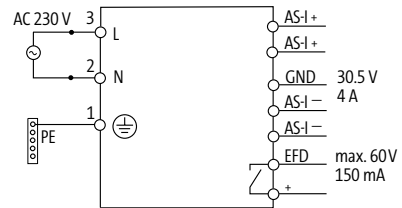
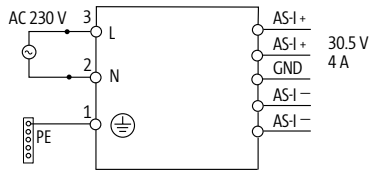

Order Data	Art-No.	Art-No.
30.5 V DC / 4 A	85381	85382

Accessories	Art-No.
Mounting plate 65 mm	89853

Input	
Input voltage	95...265 V AC
Input current	2.1 A
Inrush current after 1 ms	max. 35 A (230 V AC)
External fuse	max. 10 A (T)
Frequency	50/60 Hz

Output	
Output voltage	30.5 V DC (SELV), $\pm 2\%$
Output current	max. 4.0 A (+40 °C); 3.4 A (+55 °C)
Output rating	122 W
Mains failure bridging time	min. 14 ms (110 V AC); min. 80 ms (230 V AC)
Ripple	max. 20 mV rms
LED display	LED (green) for output voltage
Output filter	Filter acc. to AS-Interface specification

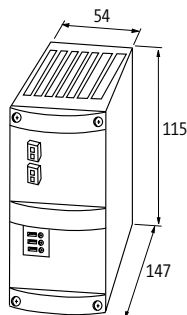

General data	
Standards	(EN 60950-1), (EN 61204-3), (EN 55022 B)
Temperature range	-10...+40 °C, to +55 °C derating (storage temperature -25...+85 °C)
Mounting method	DIN-rail mountable TH35 (EN 60715)
Efficiency	83 % (110 V AC); 85 % (240 V AC)
AS-Interface	Unit complies to AS-Interface specification for power supplies (PELV)

Dimension drawing



Murrelektronik Online Shop
onlineshop.murrelektronik.com/en

Notes

Mounting accessories			Art-No.
	Mounting plate 40 mm		
	for side mounting	for MCS and MCS-B	89851
	for side mounting	for MCS	89852
	Label plates		
	KES 20 × 8 (white)	(10 pieces/2 plates)	996067
	DIN-Rail Clip		
	DIN-rail mountable TH35 (EN 60715)		85148



BUFFER MODULES / REDUNDANCY MODULES

- Stable power supply
- Safe processes
- Increased machine availability

SAFE, INTELLIGENT, COST EFFECTIVE

Murrelektronik offers a wide range of buffer modules that bridge voltage fluctuations for **38 seconds at 10 A** or up to **several minutes at 1 A**. They are equipped with ultra capacitors instead of lead batteries like conventional uninterruptible power systems (UPS). This makes sure they are maintenance-free and cost-effective because you never have to change the batteries in Murrelektronik's buffer modules.

Overview of Buffer Modules

Load Current	Seconds								Minutes						
	0.2	0,5	1	3.6	4	7	16	21	38	1	2	4	3	5	6
1 A	●	●	●	●	●	●	●	●	●	●	●	●	●	●	●
3 A	●	●	●	●	●	●	●	●	●	●	●	●	●	●	●
5 A	●	●	●	●	●	●	●	●	●	●	●	●	●	●	●
10 A	●	●	●	●	●	●	●	●	●	●	●	●	●	●	●
20 A	●	●	●	●	●	●	●	●	●	●	●	●	●	●	●
40 A	●	●	●	●	●	●	●	●	●	●	●	●	●	●	●

- MB Cap 20 A/0.2 s
- MB Cap Ultra 3 A/7 s
- MB Cap Ultra 10 A/38 s
- Emparro Cap 20 A/1.0 s
- MB Cap Ultra 20 A/16 s
- MB Cap Ultra 40 A/3.6 s

To ensure that machines run at maximum capacity, power supply systems are often designed redundantly with two power supply units. Murrelektronik's redundancy modules decouple independent power supply units and generate a redundant 24 V DC control voltage.

Buffer Modules / Redundancy Modules



Buffer Modules

- Maintenance-free ultra capacitors

Page 1.4.1



Redundancy Modules

- Active
- Passive

Page 1.4.4

BUFFER MODULES / REDUNDANCY MODULES

Buffer modules

MB Cap Ultra 3/24 7s

7 s (3 A); 21 s (1 A)



MB Cap Ultra expansion module 3/24 12s

12 s (3 A); 36 s (1 A)



Approvals: UL^{us}
Listed

Circuit diagram

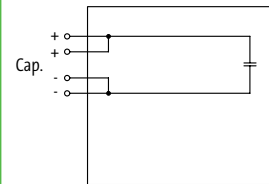
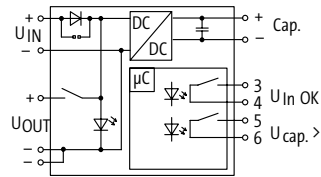

Order Data

24 V DC/3 A

Art-No.

85460

use with Art.-Nr. 85460

Art-No.

85462

Input

Input voltage

20.4...26.4 V DC

Input current

3 A

Loading time

min. 25 s

Output

Output voltage

23 V DC $\pm 2\%$

Output current

max. 3 A (+60 °C)

Buffer time

7 s (3 A); 21 s (1 A)

12 s (3 A); 36 s (1 A)

General data

Standards

(EN 60950), (EN 50178) SELV/PELV

Temperature range

-20...+60 °C (storage temperature -20...+60 °C)

Mounting method

DIN-rail mountable TH35 (EN 60715)

Efficiency

90 %

Dimension drawing

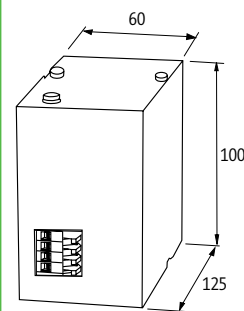
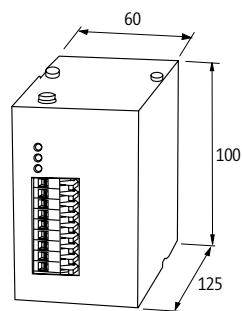

Murrelektronik Online Shop
onlineshop.murrelektronik.com/en

Notes

BUFFER MODULES / REDUNDANCY MODULES

Buffer modules

MB Cap Ultra 10/24 38s

38 s (10 A); 380 s (1 A)



MB Cap Ultra 20/24 16s

16 s (20 A); 320 s (1 A)



MB Cap Ultra 40/24 170s

3.6 s (40 A); 170 s (1 A)



Approvals: UL US Listed

Circuit diagram

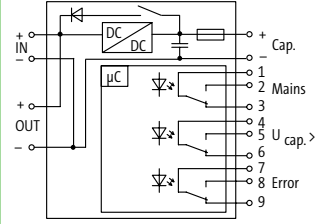
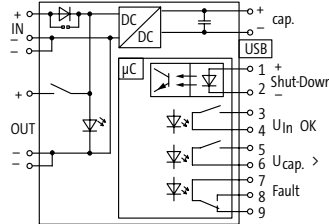
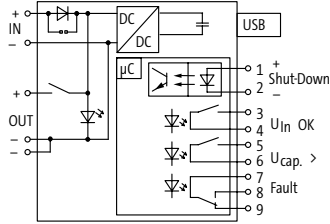

Order Data	Art-No.	Art-No.	Art-No.
24 V DC/10 A	85467		
24 V DC/20 A		85468	
24 V DC/40 A			85469
Input			
Input voltage	10.5...15 V DC; 24...27 V DC	24...26.4 V DC	21.6...26.4 V DC
Input current	10 A	20 A	40 A
Inrush current	max. 35 A/2 ms	max. 36.5 A	
Loading time	typ. 100 s; max. 210 s	typ. 40 s; max. 500 s	typ. 140 s; max. 300 s
Output			
Output voltage	11.3 V DC ±4 %; 23.3 V DC ±2 %	23.3 V DC ±2 %	25.5...19 V DC ±2 %
Output current	max. 10 A (+60 °C)	max. 20 A (+60 °C)	max. 40 A (+60 °C)
Buffer time	38 s (10 A); 380 s (1 A)	16 s (20 A); 320 s (1 A)	3.6 s (40 A); 170 s (1 A)
General data			
Standards	(EN 60950), (EN 50178) SELV/PELV	(EN 60950-1), (EN 61204-3), (EN 55011 A)	(EN 61000-6-2), (EN 61000-6-4)
Temperature range	-20...+60 °C (storage temperature -20...+60 °C)		
Mounting method	DIN-rail mountable TH35-7.5/TH35-15 (EN 60715)		
Efficiency	90 %		
Dimension drawing			

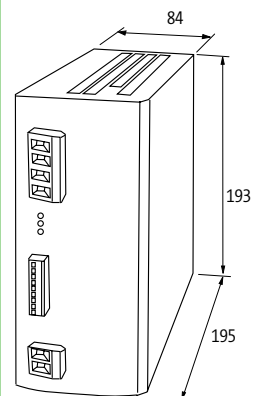
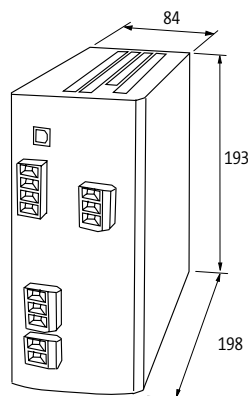
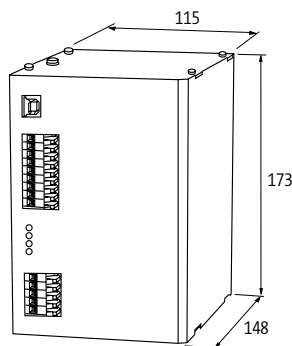

Murrelektronik Online Shop
onlineshop.murrelektronik.com/en

Notes

Buffer modules / Redundancy Modules

BUFFER MODULES / REDUNDANCY MODULES

Buffer modules

MB Cap 20/24 4s

0.2 s (20 A); 4 s (1 A)



Emparro Cap 20/24 40s

1.0 s (20 A); 40 s (1 A)



Circuit diagram

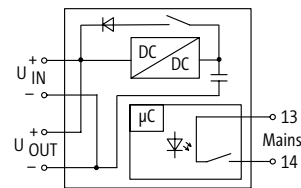
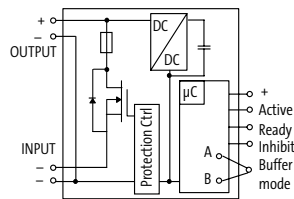

Order Data

24 V DC/20 A

cULus

Art-No.

85394

Art-No.

85458

Input

Input voltage

23...30 V DC (SELV/PELV)

Input current

85 mA

Inrush current

–

Protection of voltage spikes

max. 35 V DC

Loading time

20...45 s

Loading current

max. 500 mA

Output

Output voltage

24 V DC, 22...28 V DC

Output current

max. 20 A (+70 °C)

Current limit

26 A

Buffer time

–

Ripple

max. 200 mV rms

Parallel circuit

possible

General data

Standards

(EN 61000-6-2), (EN 61000-6-3), (EN 55022) category B, (EN 60950-1) SELV

Temperature range

0...+70 °C (storage temperature -25...+85 °C)

Mounting method

DIN-rail mountable TH35 (EN 60715)

Efficiency

95 %

Dimension drawing

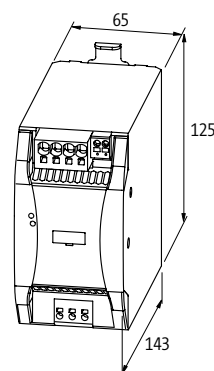
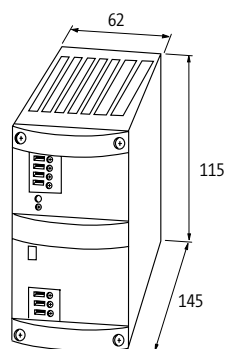

Murrelektronik Online Shop
onlineshop.murrelektronik.com/en

Notes

BUFFER MODULES / REDUNDANCY MODULES

Redundancy modules

MB Redundancy Balance 2 × 20/24

MB Redundancy Balance 2 × 20/24

Auto-Balancing (50/50)



Approvals:  

Circuit diagram

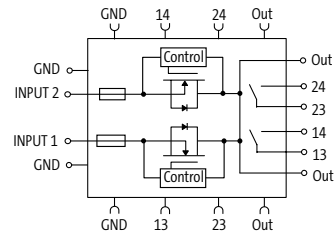
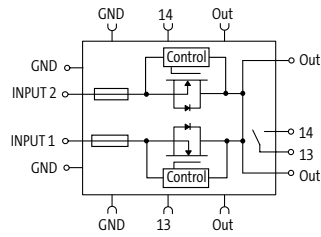

Order Data	Art-No.	Art-No.
24 V DC / 2 × 20 A / 1 × 40 A	85495	85496

Accessories	Art-No.
Bridge system 10 pcs.	9000-41034-0000001
Bridge system VE 1	9000-41034-0000002
Label plates	996067

Input	
Input voltage	24 V DC (18...30 V DC)
Input current	2 × 20 A
Total current	max. 40 A
Protection against reverse polarization	max. 30 V DC
Auto-Balancing (50/50)	no yes

Output	
Output voltage	24 V DC (18...30 V DC)
Output current (40 A)	(-25...+60 °C) continuous
Output current (52 A)	(-25...+40 °C) (-25...+40 °C) without balance
Output current (26 A)	(-25...+40 °C) for redundancy operation
LED display	LED (red/green)
Alarm output	potential free (relay contact) for input voltage potential free (relay contact) for input voltage / load distribution

General data	
Standards	(EN 61000-6-2), (EN 61000-6-3)
Bridging concept	two sides, with spring clamp terminals or bridge set (max. 40 A)
Relative humidity	5...95 %, no condensation
Efficiency	99.5 %
Temperature range	-25...+60 °C (storage temperature -40...+85 °C)
Connection	Spring clamp terminals
Mounting method	DIN-rail mountable TH35 (EN 60715)

Dimension drawing

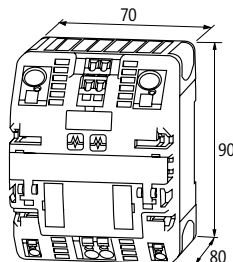

Murrelektronik Online Shop
onlineshop.murrelektronik.com/en

Notes

BUFFER MODULES / REDUNDANCY MODULES

Redundancy modules

MB Diode

Approvals:  **UL** US
Listed



Circuit diagram

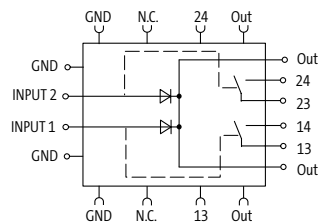

Order Data

24 V DC / 2 × 20 A / 1 × 40 A

Art-No.

85396

Accessories

Bridge system 10 pcs.

9000-41034-0000001

Bridge system VE 1

9000-41034-0000002

Label plates

996067

Input

Input voltage 24 V DC (21...30 V DC)

Input current 2 × 20 A / 1 × 40 A

Total current max. 40 A

Protection against reverse polarization Internal protection against reverse polarization up to 60 V DC

Auto-Balancing (50/50) no

Output

Output voltage 24 V DC (21...30 V DC)

Output current 20 A (-25...+55 °C); 40 A (-25...+40 °C)

Overload at 20 A +50 % for 4 s

LED display LED (green)

Alarm output potential free alarm output per channel (relay contact)

General data

Standards (EN 61000-6-2), (EN 61000-6-3)

Bridging concept two sides, with spring clamp terminals or bridge set (max. 40 A)

Relative humidity 5...95 %, no condensation

Power loss U (approx. 0.5 V) × I

Efficiency 97 %

Temperature range -25...+55 °C (20 A); -25...+40 °C (40 A); (storage temperature -25...+85 °C)

Connection Spring clamp terminals

Mounting method DIN-rail mountable TH35 (EN 60715)

Dimension drawing

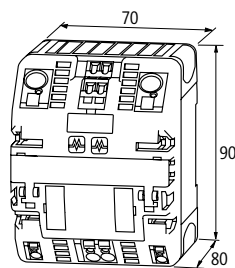

Murrelektronik Online Shop
onlineshop.murrelektronik.com/en

Notes

MICO INTELLIGENT POWER DISTRIBUTION

- Monitor
- Detect
- React

FIRST CLASS POWER DISTRIBUTION

MICO is the intelligent power distribution module from Murrelektronik for 24 VDC. It monitors currents, indicates when approaching the maximum load and make targeted circuit isolations during overload or short circuit conditions. This makes sure systems run at maximum capacity.

EXAMPLE: Why don't circuit breakers trigger reliably in a 24 VDC system?

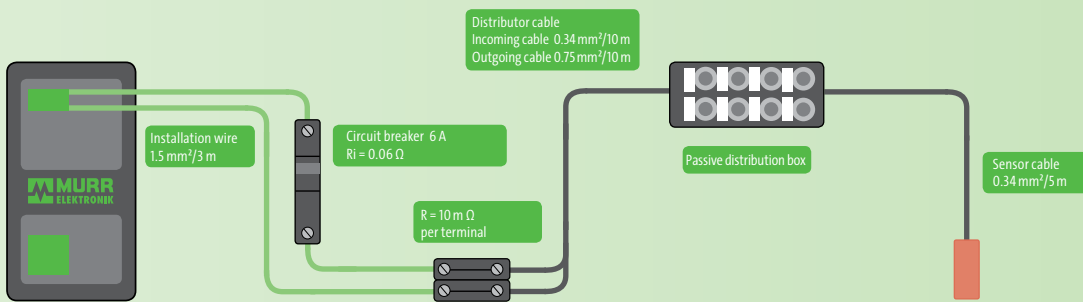

Specific resistance of copper (ρ) = 0.0178 ($\Omega \times \text{mm}^2 / \text{m}$)
 Total loop resistance = 1.32 Ω
 Calculation of maximum current flow (Limited by loop resistance)

$$I = \frac{U}{R} = \frac{24 \text{ V}}{1.32 \Omega} = 18.18 \text{ A}$$

Required tripping current for the 6 A type C circuit breaker
 $14 \times I_{\text{Nenn}} = 14 \times 6 \text{ A} = 84 \text{ A}$



Tripping current > max. Current flow
 84 A > 18.18 A

MICO



MICO CLASSIC

- Adjustable current ranges
- Channels with remote switch on function
- Group alarm output

Page 1.5.3



MICO+

- Adjustable current ranges
- Channels with remote switch on/off function
- Preventive diagnostics

Page 1.5.7



MICO BASIC

- Preset current ranges
- Small size

Page 1.5.7



MICO FUSE

- Socket for glass tube fuses

Page 1.5.10

INTELLIGENT POWER DISTRIBUTION

Over current protection device

- adjustable current ranges
- Early warning (90%)

Approvals:  



MICO+ 4.4

4 channels



MICO+ 4.6

4 channels

Circuit diagram

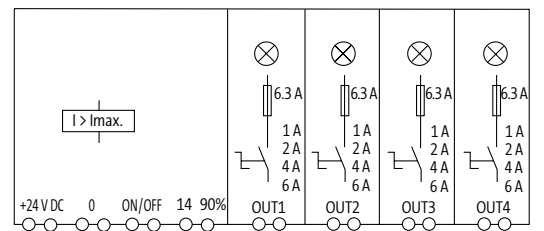
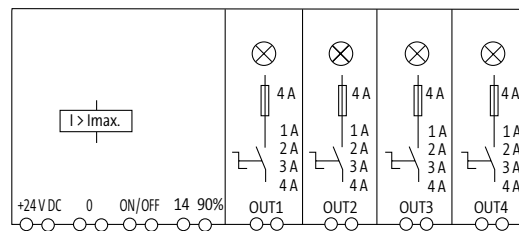

Order Data

1 A, 2 A, 3 A, 4 A

1 A, 2 A, 4 A, 6 A

Art-No.

9000-41084-0100400

Art-No.

9000-41084-0100600

Technical Data

Operating voltage	24 V DC (18...30 V DC)	
Current adjustment	1 A, 2 A, 3 A, 4 A, by countersunk rotary switch, sealed	1 A, 2 A, 4 A, 6 A, by countersunk rotary switch, sealed
Group alarm output	max. 20 mA; high: all channels ON; low: not all channels ON	
Inrush capacity	max. 20 mF (per channel)	
Remote start (ON)	10...30 V DC	
Remote start (OFF)	10...30 V DC	
Impulse length	min. 20 ms	
Early warning (90%)	max. 20 mA; high: one channel over 90%; low: all channels under 90%	

General data

Connection	Spring clamp terminals
Input terminals	2 × 16 mm ²
Output terminals	per output 2 × 1.5 mm ²
Alarm terminals	2.5 mm ²
Bridging concept	two sides, with spring clamp terminals or bridge set (max. 40 A)
Mounting method	DIN-rail mountable TH35 (EN 60715)
Temperature range	0...+55 °C (storage temperature -40...+80 °C)

Dimension drawing

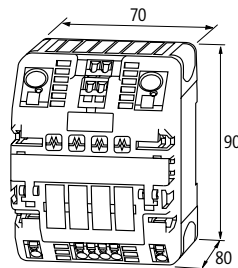

Murrelektronik Online Shop
onlineshop.murrelektronik.com/en

Notes

INTELLIGENT POWER DISTRIBUTION

Over current protection device

- adjustable current ranges
- Early warning (90%)



MICO+ 4.10

4 channels



Circuit diagram

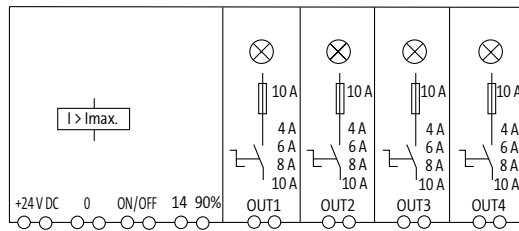

Order Data	Art-No.
4 A, 6 A, 8 A, 10 A	9000-41084-0401000

Technical Data	
Operating voltage	24 V DC (18...30 V DC)
Current adjustment	4 A, 6 A, 8 A, 10 A, by countersunk rotary switch, sealed
Group alarm output	max. 20 mA; high: all channels ON; low: not all channels ON
Inrush capacity	max. 20 mF (per channel)
Remote start (ON)	10...30 V DC
Remote start (OFF)	10...30 V DC
Impulse length	min. 20 ms
Early warning (90%)	max. 20 mA; high: one channel over 90%; low: all channels under 90%

General data	
Connection	Spring clamp terminals
Input terminals	2 × 16 mm ²
Output terminals	per output 2 × 1.5 mm ²
Alarm terminals	2.5 mm ²
Bridging concept	two sides, with spring clamp terminals or bridge set (max. 40 A)
Mounting method	DIN-rail mountable TH35 (EN 60715)
Temperature range	0...+55 °C (storage temperature -40...+80 °C)

Dimension drawing

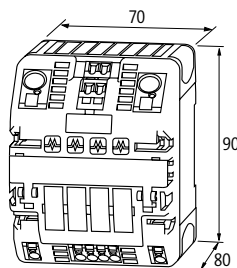

Murrelektronik Online Shop
onlineshop.murrelektronik.com/en

Notes

INTELLIGENT POWER DISTRIBUTION

Over current protection device



MICO 4.4

4 channels



MICO 2.4

2 channels



Circuit diagram

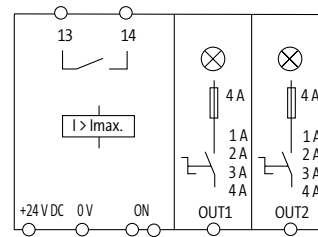
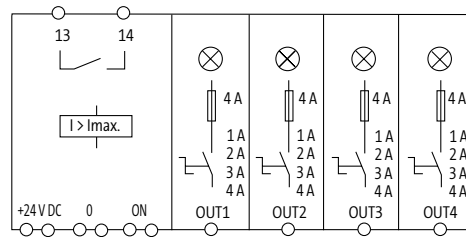

Order Data	Art-No.	Art-No.
1 A, 2 A, 3 A, 4 A	9000-41034-0100400	9000-41042-0100400

Technical Data		
Operating voltage	24 V DC (18...30 V DC)	
Current adjustment	1 A, 2 A, 3 A, 4 A, by countersunk rotary switch, sealed	
Inrush capacity	max. 20 mF (per channel)	
Group alarm output	potential free alarm output 30 V AC/DC, 100 mA	
Remote start (ON)	10...30 V DC	
Impulse length	min. 20 ms	
General data		
Connection	Spring clamp terminals	
Input terminals	2 x 16 mm ²	1 x 16 mm ²
Output terminals	per output 1 x 4 mm ²	
Alarm terminals	2.5 mm ²	
Bridging concept	two sides, with spring clamp terminals or bridge set (max. 40 A)	one side, with spring clamp terminals or bridge set (max. 40 A)
Mounting method	DIN-rail mountable TH35 (EN 60715)	
Temperature range	0...+55 °C (storage temperature -40...+80 °C)	

Dimension drawing

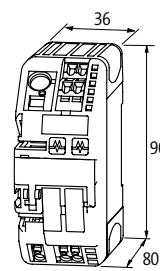
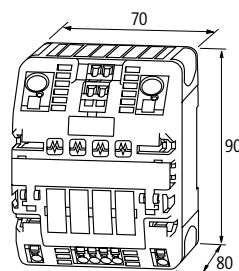

Murrelektronik Online Shop
onlineshop.murrelektronik.com/en

Notes

INTELLIGENT POWER DISTRIBUTION

Over current protection device



MICO 4.6

4 channels



MICO 2.6

2 channels



Circuit diagram

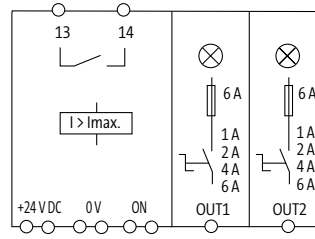
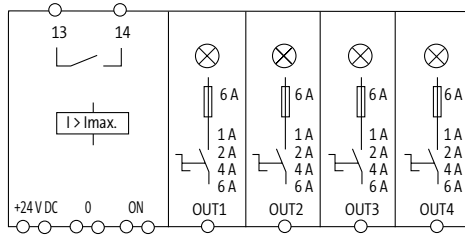

Order Data	Art-No.
1 A, 2 A, 4 A, 6 A	9000-41034-0100600

Technical Data	Art-No.
Operating voltage	24 V DC (18...30 V DC)

Current adjustment	1 A, 2 A, 4 A, 6 A, by countersunk rotary switch, sealed
--------------------	--

Inrush capacity	max. 20 mF (per channel)
-----------------	--------------------------

Group alarm output	potential free alarm output 30 V AC/DC, 100 mA
--------------------	--

Remote start (ON)	10...30 V DC
-------------------	--------------

Impulse length	min. 20 ms
----------------	------------

General data

Connection	Spring clamp terminals
------------	------------------------

Input terminals	2 × 16 mm ²	1 × 16 mm ²
-----------------	------------------------	------------------------

Output terminals	per output 1 × 4 mm ²
------------------	----------------------------------

Alarm terminals	2.5 mm ²
-----------------	---------------------

Bridging concept	two sides, with spring clamp terminals or bridge set (max. 40 A)	one side, with spring clamp terminals or bridge set (max. 40 A)
------------------	--	---

Mounting method	DIN-rail mountable TH35 (EN 60715)
-----------------	------------------------------------

Temperature range	0...+55 °C (storage temperature -40...+80 °C)
-------------------	---

Dimension drawing

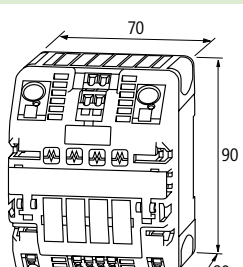
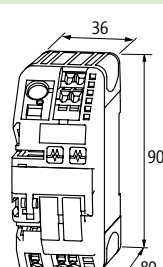
	
---	--

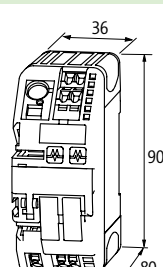
	
---	--

	
---	--

	
---	--

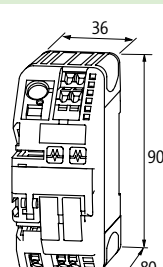
	
---	--

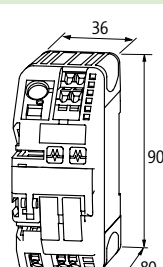
	
---	--

	
---	--

	
---	--

	
---	--

	
---	--

	
---	--

	
---	--

	
---	--

	
---	--

	
---	--

	
---	--

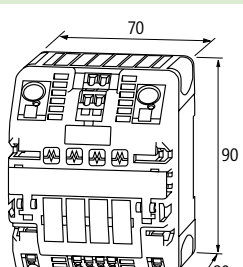
	
---	--

	
---	--

	
---	--

	
---	--

	
---	--

	
---	--

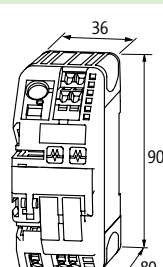
	
---	--

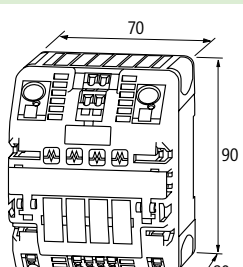
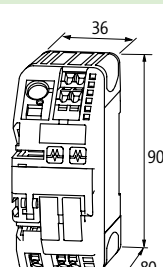
	
---	--

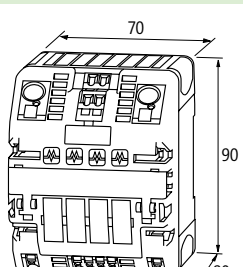
	
---	--

	
---	--

	
---	--

	
---	--

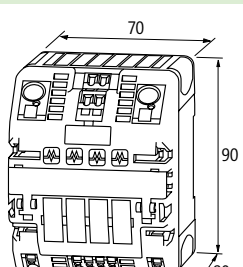
	
---	--

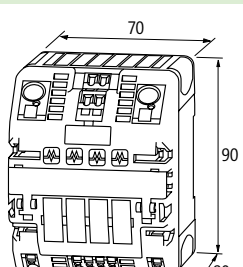
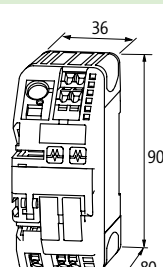
	
---	--

INTELLIGENT POWER DISTRIBUTION

Over current protection device

MICO 4.10

4 channels



MICO 2.10

2 channels



Approvals:  



Circuit diagram

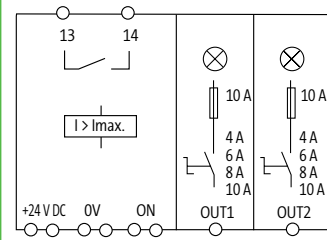
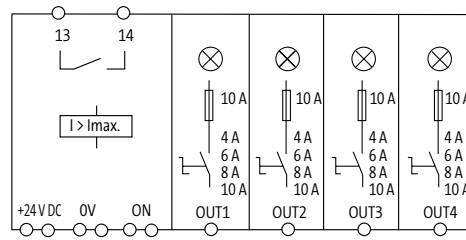

Order Data	Art-No.	Art-No.
4 A, 6 A, 8 A, 10 A	9000-41034-0401000	9000-41042-0401000
Technical Data		
Operating voltage	24 V DC (18...30 V DC)	
Current adjustment	4 A, 6 A, 8 A, 10 A, by countersunk rotary switch, sealed	
Inrush capacity	max. 20 mF (per channel)	
Group alarm output	potential free alarm output 30 V AC/DC, 100 mA	
Remote start (ON)	10...30 V DC	
Impulse length	min. 20 ms	
General data		
Connection	Spring clamp terminals	
Input terminals	2 × 16 mm ²	1 × 16 mm ²
Output terminals	per output 1 × 4 mm ²	
Alarm terminals	2.5 mm ²	
Bridging concept	two sides, with spring clamp terminals or bridge set (max. 40 A)	one side, with spring clamp terminals or bridge set (max. 40 A)
Mounting method	DIN-rail mountable TH35 (EN 60715)	
Temperature range	0...+55 °C (storage temperature -40...+80 °C)	
Dimension drawing		

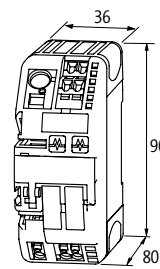
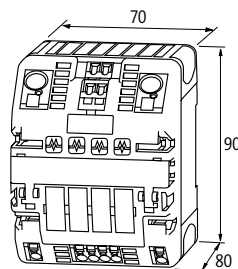

Murrelektronik Online Shop
onlineshop.murrelektronik.com/en

Notes

INTELLIGENT POWER DISTRIBUTION

Over current protection device

MICO 4.4.10 ACTUATOR-SENSOR

MICO 4.10 SPEED START

4 channels
optimized start-up behavior



Circuit diagram

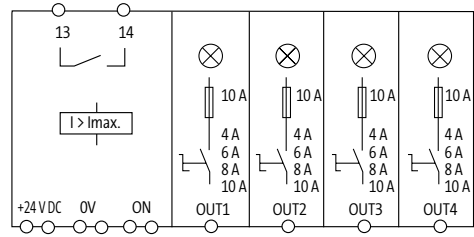
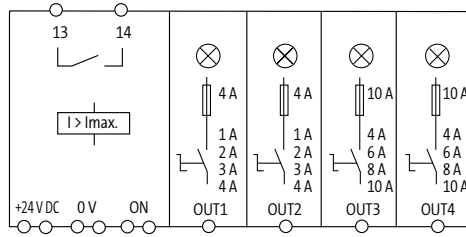

Order Data	Art-No.	Art-No.
1 A, 2 A, 3 A, 4 A; 4 A, 6 A, 8 A, 10 A	9000-41034-0101000	
4 A, 6 A, 8 A, 10 A		9000-41034-0401005

Technical Data		
Operating voltage	24 V DC (18...30 V DC)	
Current adjustment	1 A, 2 A, 3 A, 4 A; 4 A, 6 A, 8 A, 10 A, by countersunk rotary switch, sealed	4 A, 6 A, 8 A, 10 A, by countersunk rotary switch, sealed
Inrush capacity	max. 20 mF (per channel)	max. 30 mF (per channel)
Group alarm output	potential free alarm output 30 V AC/DC, 100 mA	
Remote start (ON)	10...30 V DC	
Impulse length	min. 20 ms	

General data	
Connection	Spring clamp terminals
Input terminals	2 × 16 mm ²
Output terminals	per output 1 × 4 mm ²
Alarm terminals	2.5 mm ²
Bridging concept	two sides, with spring clamp terminals or bridge set (max. 40 A)
Mounting method	DIN-rail mountable TH35 (EN 60715)
Temperature range	0...+55 °C (storage temperature -40...+80 °C)

Dimension drawing

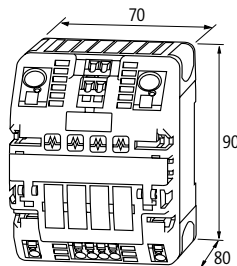

Murrelektronik Online Shop
onlineshop.murrelektronik.com/en

Notes

Over current protection device

– preset tripping current

Approvals:



MICO BASIC 8.2

8 channels



MICO BASIC 8.4

8 channels

MICO BASIC 8.6

8 channels

Circuit diagram

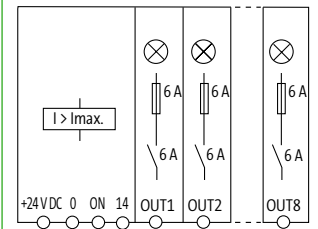
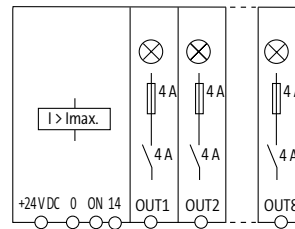
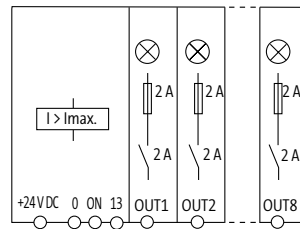

Order Data	Art-No.	Art-No.	Art-No.
2 A	9000-41068-0200000		
4 A		9000-41068-0400000	
6 A			9000-41068-0600000

Technical Data			
Operating voltage	24 V DC (18...30 V DC)		
Current adjustment	2 A	4 A	6 A
Group alarm output	max. 20 mA; high: all channels ON; low: not all channels ON		
Inrush capacity	max. 20 mF (per channel)		
Remote start (ON)	10...30 V DC		
Impulse length	min. 20 ms		

General data	
Input terminals	1 × 16 mm ²
Output terminals	per output 1 × 4 mm ²
Alarm terminals	2.5 mm ²
Bridging concept	one side, with spring clamp terminals or bridge set (max. 40 A)
Temperature range	0...+55 °C (storage temperature -40...+80 °C)
Connection	Spring clamp terminals
Mounting method	DIN-rail mountable TH35 (EN 60715)

Dimension drawing

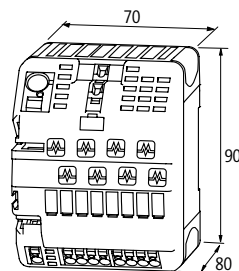

Murrelektronik Online Shop
onlineshop.murrelektronik.com/en

Notes

INTELLIGENT POWER DISTRIBUTION

Over current protection device

– preset tripping current



MICO BASIC 4.2

4 channels



MICO BASIC 4.4

4 channels

MICO BASIC 4.6

4 channels

Circuit diagram

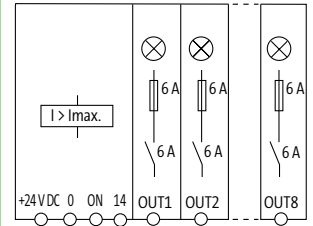
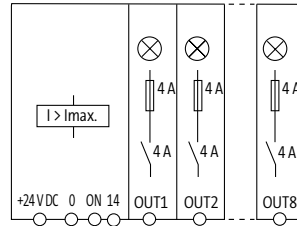
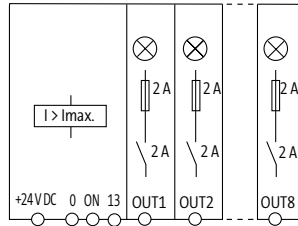

Order Data	Art-No.	Art-No.	Art-No.
2 A	9000-41064-0200000		
4 A		9000-41064-0400000	
6 A			9000-41064-0600000

Technical Data			
Operating voltage	24 V DC (18...30 V DC)		
Current adjustment	2 A	4 A	6 A
Inrush capacity	max. 20 mF (per channel)		
Group alarm output	max. 20 mA; high: all channels ON; low: not all channels ON		
Remote start (ON)	10...30 V DC		
Impulse length	min. 20 ms		

General data	
Connection	Spring clamp terminals
Input terminals	1 × 16 mm ²
Output terminals	per output 1 × 4 mm ²
Alarm terminals	2.5 mm ²
Bridging concept	one side, with spring clamp terminals or bridge set (max. 40 A)
Mounting method	DIN-rail mountable TH35 (EN 60715)
Temperature range	0...+55 °C (storage temperature -40...+80 °C)

Dimension drawing

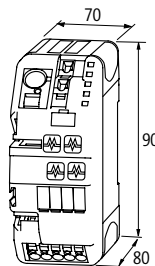

Murrelektronik Online Shop
onlineshop.murrelektronik.com/en

Notes

INTELLIGENT POWER DISTRIBUTION

Over current protection device

– preset tripping current

MICO BASIC 5.2/3.6

8 channels



Approvals:

Circuit diagram

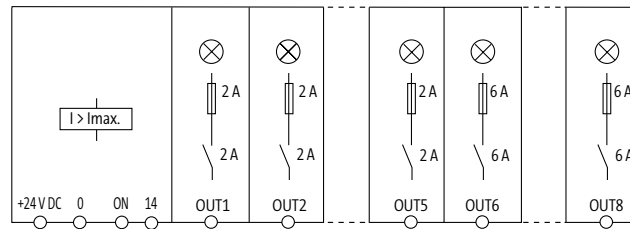

Order Data

Art-No.

9000-41068-0200600

Technical Data

Operating voltage	24 V DC (18...30 V DC)
Current adjustment	5 × 2 A; 3 × 6 A
Inrush capacity	max. 20 mF (per channel)
Group alarm output	max. 20 mA; high: all channels ON; low: not all channels ON
Remote start (ON)	10...30 V DC
Impulse length	min. 20 ms

General data

Connection	Spring clamp terminals
Input terminals	1 × 16 mm ²
Output terminals	per output 1 × 4 mm ²
Alarm terminals	2.5 mm ²
Bridging concept	one side, with spring clamp terminals or bridge set (max. 40 A)
Mounting method	DIN-rail mountable TH35 (EN 60715)
Temperature range	0...+55 °C (storage temperature -40...+80 °C)

Dimension drawing

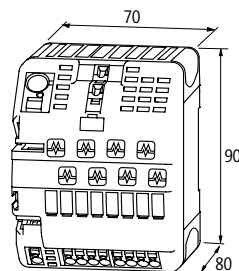

Murrelektronik Online Shop
onlineshop.murrelektronik.com/en

Notes

INTELLIGENT POWER DISTRIBUTION

Socket for glass tube fuses

MICO FUSE 24 LED

8 channels



MICO FUSE 250

8 channels



Approvals:

Circuit diagram

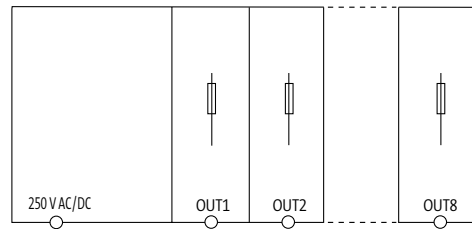
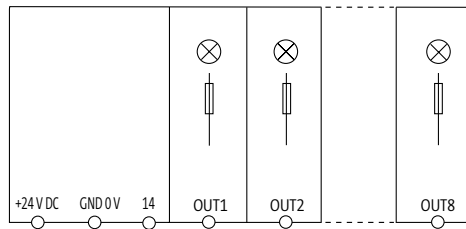

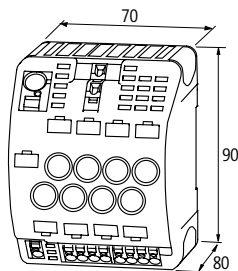

Order Data	Art-No.	Art-No.
24 V DC	9000-41078-0600001	
max. 250 V AC/DC		9000-41078-0600002
Technical Data		
Operating voltage	24 V DC (18...30 V DC)	max. 250 V AC/DC
Operating current	max. 6 A (40 °C)	
Total current	max. 40 A	
Group alarm output	max. 20 mA; high: all channels ON; low: not all channels ON	-
General data		
Connection	Spring clamp terminals	
Input terminals	1 × 16 mm ²	
Output terminals	1 × 0.5...4 mm ²	
Alarm terminals	2.5 mm ²	-
Mounting method	DIN-rail mountable TH35 (EN 60715)	
Temperature range	-25...+55 °C	
Dimension drawing		



Murrelektronik Online Shop
onlineshop.murrelektronik.com/en

Notes

Accessories			Art-No.
	Bridge system		
		Quantity: 1 piece	9000-41034-0000002
		Quantity: 10 pcs.	9000-41034-0000001
	Shortened buttons 1 set (4 pcs.)		9000-41034-0000003
	Label plates		
	KES 20 × 8 (white)	10 pieces/2 plates	996067
	KMR 5 × 10 (white)	(64 pieces/4 plates)	996078
	Glass automotive fuse		
	2 A (T)		9000-41078-0000002
	4 A (T)		9000-41078-0000004
	6 A (T)		9000-41078-0000006
	Fuse cap		
			9000-41078-0000010



CONVERTERS / RECTIFIERS

- Compact design
- Galvanic separation
- Switch mode models

SMALL VOLTAGE CONVERTERS

Voltages in control systems often have to be converted. The DC/DC converters in the MDD series do this perfectly! It doesn't matter if you need 5, 10, 12 or 24 volts – Murrelektronik has the right product.

If there is only AC voltage available, the NG rectifier series can convert into DC voltage. All models can be conveniently mounted in the control cabinet on DIN rail.

AC/DC and DC/DC Converters



MDD, GLS, GSS, NG, NT

- Output current range: 0.5...4A

Page 1.6.1

Rectifiers



NG

- Output current range: 2.6...10A

Page 1.6.3

CONVERTERS / RECTIFIERS

DC/DC converters

– AC/DC converters

GLS

OUTPUT regulated: 5 V DC
Current: 1.2 A



GSS

OUTPUT switched mode: 5 V DC
Current: 4 A



NT

OUTPUT: 5...35 V DC
Current: 3.5 A



Circuit diagram

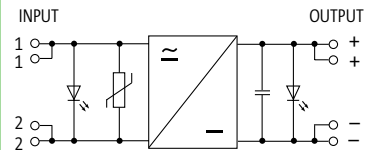
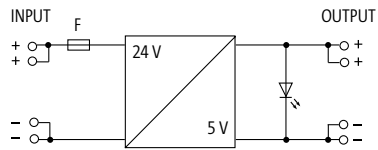

Order Data	Art-No.	Art-No.	Art-No.
5 V DC/1.2 A	85600		
5 V DC/4 A		85650	
5...35 V DC/3.5 A			85660

Input			
Input voltage	24 V DC (+10/-15 %)	15...40 V DC	10...32 V AC; 12...42 V DC
Input current	1.2 A	1 A, 4 A (24 V DC)	max. 3 A
Input fuse (internal)	2 A (T)		6.3 A (T)
Frequency	–		50/60 Hz
Output			
Output voltage	5 V DC (SELV), ±5 %		5...35 V DC (SELV), U _{out-max.} = U _{in} - 5 V
Output current	max. 1.2 A	max. 4 A	max. 3.5 A
Ripple	max. 0.2 % eff		max. 300 mV rms
Output fuse	short-circuit protected		

General data			
Temperature range	-20...+60 °C, no condensation		
Mounting method	DIN-rail mountable TH35 (EN 60715)		

Dimension drawing

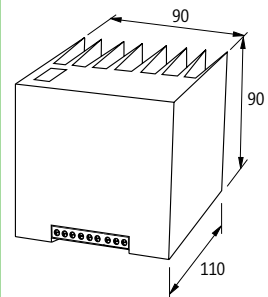
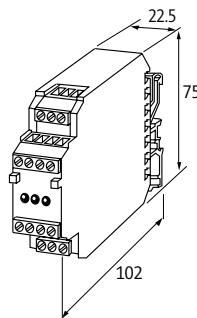
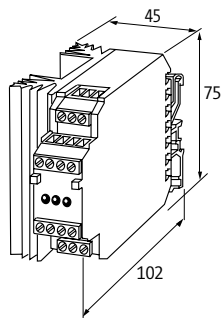

Rectifier modules

– Single-phase

– IP00

NG 2

INPUT: max. 41 V AC



NG 5

INPUT: max. 41 V AC

NG 10

INPUT: max. 29 V AC



Circuit diagram

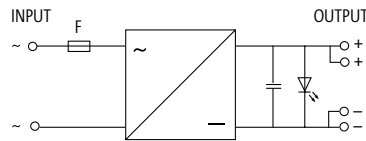

Order Data	H×W×D	Art-No.	H×W×D	Art-No.	H×W×D	Art-No.
24 V DC/2.6 A	86×45×92 mm	85700				
24 V DC/5 A			90×68×87 mm	85710		
24 V DC/10 A						85730
Input						
Input voltage	max. 5...44 V AC			max. 29 V AC		
Input current	max. 2.6 A; 1.8 A (+60 °C)			max. 5 A; 4 A (+60 °C)		
Frequency	45...65 Hz			50/60 Hz (or as additional smoothing for DC)		
Input fuse (external)	–			8 A (T), 5 × 20 mm		
Input fuse (internal)	3.15 A (T), 5 × 20 mm			–		
Output						
Output voltage	U-IN × 1.16/max. 60 V DC			U-IN × 1.16/max. 39 V DC		
Output current	max. 2.6 A; 1.8 A (+60 °C)			max. 5 A; 4 A (+60 °C)		
Ripple	max. 5 % rms					
Output filter	smoothed with smoothing capacitor and LED					
General data						
Temperature range	-20...+60 °C					
Mounting method	DIN-rail mountable TH35 (EN 60715)					
Dimension drawing						

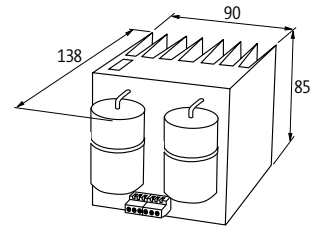
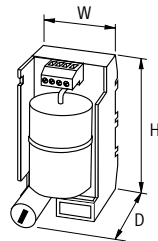

Murrelektronik Online Shop
onlineshop.murrelektronik.com/en

Notes



MODLINK MSVD – CONTROL CABINET POWER OUTLETS

- Safe
- Easy to install
- Meet international standards

KEEP IT SAFE – EVEN IN THE CONTROL CABINETS

Using components temporarily in the control cabinet require right power outlets.
Murrelektronik has the right tools: a wide range of power outlets for different countries.

Components that still carry voltage after they are shut down need to be specially marked (according to DIN VDE 0105-1 and IEC 204-1 / EN 60504-1 / DIN VDE 0113 Part 1). These power outlets are orange.

Control Cabinet Power Outlets



German standard (VDE)

- for DIN-rail mounting acc. to EN 60715
- with screw terminals or spring clamp terminals

Page 1.7.1



French Standard (UTE)

- for DIN-rail mounting acc. to EN 60715
- with screw terminals or spring clamp terminals

Page 1.7.1



American Standard (NEMA 5-15)

- for DIN-rail mounting acc. to EN 60715
- with screw terminals
- LED display

Page 1.7.2



Different international standards







- for DIN-rail mounting acc. to EN 60715

Page 1.7.3





CONTROL CABINET POWER OUTLETS

German standard (VDE)			Art-No.
	Germany (VDE) white Screw terminals: max. 2 × 6 mm ² Operating voltage: max. 250 V AC	VDE	67900
	Germany (VDE) white Screw terminals: max. 2 × 6 mm ² Operating voltage: max. 250 V AC LED (yellow)	VDE	67901
	Germany (VDE) yellow Screw terminals: max. 2 × 6 mm ² Operating voltage: max. 250 V AC	VDE	67950
	Germany (VDE) orange Screw terminals: max. 2 × 2.5 mm ² (AWG 14) Operating voltage: max. 250 V AC	VDE	4000-72000-0140000
	Germany (VDE) white Spring clamp terminals: max. 2 × 2.5 mm ² (AWG 14) Operating voltage: max. 250 V AC	VDE	4000-72000-0160000
French standard (UTE)			Art-No.
	France (UTE-NF) white Screw terminals: max. 2 × 6 mm ² Operating voltage: max. 250 V AC	UTE	67910
	France (UTE-NF) white Screw terminals: max. 2 × 6 mm ² Operating voltage: max. 250 V AC LED (yellow)	UTE	67911





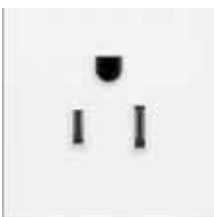

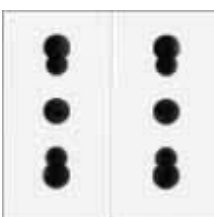
CONTROL CABINET POWER OUTLETS

French standard (UTE)			Art-No.
	France (UTE-NF) white Screw terminals: max. 2 × 4 mm ² Operating voltage: max. 250 V AC	UTE	4000-72000-3010000
	France (UTE-NF) red Screw terminals: max. 2 × 2.5 mm ² (AWG 14) Operating voltage: max. 250 V AC	UTE	4000-72000-0130000
	France (UTE-NF) orange Screw terminals: max. 2 × 2.5 mm ² (AWG 14) Operating voltage: max. 250 V AC	UTE	4000-72000-0150000
American standard			Art-No.
	USA (NEMA 5-15) Screw terminals: max. 2.5 mm ² (AWG 14) Operating voltage: max. 127 V AC LED (yellow)	cURus	676166
	USA (NEMA 5-15) Screw terminals: max. 2.5 mm ² (AWG 14) Operating voltage: max. 127 V AC LED (yellow)	Connection turned cURus	676152
	USA (2 × NEMA-GFCI 5-15) Screw terminals: max. 6 mm ² Operating voltage: max. 127 V AC max. 15 A LED (yellow)	(Ground Fault Circuit Interrupter) cURus	67980
	USA (2 × NEMA-GFCI 5-20) Screw terminals: max. 6 mm ² Operating voltage: max. 125 V AC max. 20 A LED (yellow)	(Ground Fault Circuit Interrupter) cURus	67981

CONTROL CABINET POWER OUTLETS

American standard			Art-No.
	<p>USA (2 × NEMA 5-15) Screw terminals: max. 6 mm² max. 15 A Operating voltage: max. 125 V AC</p>	cURus	67982
	<p>USA (2 × NEMA 5-20) Screw terminals: max. 6 mm² max. 20 A Operating voltage: max. 125 V AC</p>	cURus	67983
International standards			Art-No.
	<p>EURO/ USA (white) Screw terminals: max. 2 × 2.5 mm² (AWG 14) Operating voltage: EURO: max. 250 V AC, USA: max. 127 V AC</p>		4000-72000-0100000
	<p>USA (NEMA 5-15) white Screw terminals: max. 2 × 2.5 mm² (AWG 14) Operating voltage: max. 125 V AC</p>		4000-72000-0040000
	<p>England (white) Screw terminals: max. 2 × 4 mm² Operating voltage: max. 250 V AC</p>	BS	4000-72000-0060000
	<p>England (orange) Screw terminals: max. 2 × 4 mm² Operating voltage: max. 250 V AC</p>	BS	4000-72000-0190000
	<p>Italy (white) Screw terminals: max. 2 × 2.5 mm² (AWG 14) Operating voltage: max. 250 V AC</p>	Double CEI 23-16	4000-72000-0070000

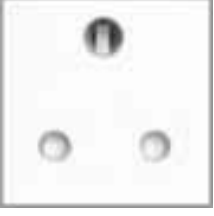
CONTROL CABINET POWER OUTLETS

International standards			Art-No.
	<p>Italy (white) Screw terminals: max. 2 × 2.5 mm² (AWG 14) Operating voltage: max. 250 V AC</p>	VDE/CEI 23-16	4000-72000-0180000
	<p>Denmark (white) Spring clamp terminals: max. 2 × 2.5 mm² (AWG 14) Operating voltage: max. 250 V AC</p>		4000-72000-0170000
	<p>Swiss (white) Spring clamp terminals: max. 2 × 1.5 mm² (AWG 16) Operating voltage: max. 250 V AC</p>		4000-72000-0120000
	<p>Australia (white) Screw terminals: max. 2 × 4 mm² Operating voltage: max. 240 V AC</p>		4000-72000-0090000
	<p>India (white) Screw terminals: max. 2 × 4 mm² Operating voltage: max. 240 V AC</p>	IS 1293	4000-72000-3210000
	<p>China (white) Screw terminals: max. 2 × 4 mm² Operating voltage: max. 250 V AC</p>	CCC	4000-72000-3250000

NOTES

A large grid of small dots for taking notes, consisting of 25 columns and 35 rows.



EMC FILTERS FOR MAXIMUM SAFETY

- Meets EMC guidelines
- Increases interference protection
- Decreases interference emissions

KEEP IT SAFE – EVEN IN THE CONTROL CABINETS

Mains filters are used to reduce interference without affecting the supply. Murrelektronik's filters decrease incoming interference, which can affect sensitive equipment, and also decrease outgoing interference from the equipment they are connected to, which could damage the mains supply. Typical sources of continuous interference are switch mode power supplies, motors and phase controllers.

These sources are made up of inductive and capacitive components and work the best when their impedance is matched to the source of the interference. In regards to grounding, it's important to have a low impedance. Ideally, the filter should be as close as possible to the point where the cable enters the cabinet. If that's not possible, then shielded cables should be used between the filter and the entry point. Ground straps should be as short as possible and connection surfaces should be free from paint, etc.

Single-phase



MEF 1/1 – one-stage

- Operating voltage: max. 250 V AC/DC, 0..60 Hz
- Nominal current: 10...20 A

Page 1.8.1



MEF 1/2 SY and MEF 1/2 AS – two-stage

- Operating voltage: max. 250 V AC/DC, 0..60 Hz
- Nominal current: 10...16 A

Page 1.8.2

Three-phase



MEF 3/1 N – one-stage

- Operating voltage: max. 3 x 440 V AC
- Nominal current: 3...20 A

Page 1.8.4



MEF 3/1 N HD – one-stage

- Operating voltage: max. 3 x 500 V AC
- Nominal current: 10...135 A

Page 1.8.5



MEF 3/1 and MEF 3/2 – one and two-stage

- Operating voltage: max. 3 x 500 V AC / 3 x 600 V AC
- Nominal current: 8...180 A

Page 1.8.6

EMC FILTERS

1-phase, 1-stage

– DIN-rail mountable

Approvals:  

MEF 1/1

for universal applications



Circuit diagram

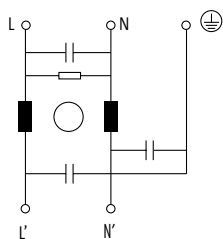

Order Data

	Art-No.
10 A	10415
20 A	10416

Technical Data

Operating voltage	max. 250 V AC/300 V DC
Operating frequency	50...60 Hz
Consumption at 250 V AC	max. 5 mA
Overload current	18 × (IN t) max. 0.5 ms; 1.5 × (IN t) max. 1 min. (1 × per hour)

General data

Climatic category	25/085/21 (EN 60068-1)
Test isolation voltage	L - N: 2.7 kV DC, 2 s; L - L: 2.1 kV DC, 2 s (EN 60939-2)
Connection	Screw connection, touch protected
Mounting method	DIN-rail mountable TH35 (EN 60715)

Dimension drawing

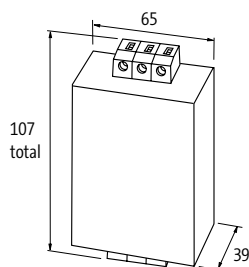

Murrelektronik Online Shop
onlineshop.murrelektronik.com/en

Notes

EMC FILTERS

1-phase, 2-stage

- DIN-rail mountable

Approvals:  

MEF 1/2 SY

against symmetrical interferences



Circuit diagram

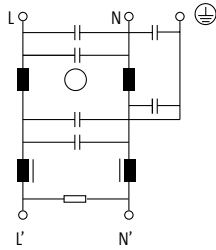

Order Data	Art-No.
1 A	10460
2 A	10461
3 A	10462
4 A	10463
6 A	10464
16 A	10466

Technical Data	
Operating voltage	max. 250 V AC/300 V DC
Operating frequency	50..60 Hz
Overload current	18 × (IN t) max. 0.5 ms; 1.5 × (IN t) max. 1 min. (1 × per hour)
Consumption at 250 V AC	max. 5 mA

General data	
Climatic category	25/085/21 (EN 60068-1)
Test isolation voltage	L - N: 2.7 kV DC, 2 s; L - L: 2.1 kV DC, 2 s (EN 60939-2)
Connection	Screw connection, touch protected
Mounting method	DIN-rail mountable TH35 (EN 60715)

Description	
Functional description	The single phase 2-stage EMC filters MEF 1/2 are used in the range 0.1...30 MHz to suppress cable carried interference on mains and control cables. The best filter performance is achieved by using short connection wires (suggestion: earth connection < 10 cm) and the largest possible diameter. The EMC filters work bi-directionally (in both directions). The filters are for demanding applications. The filters are designed for use with fixed modules. One step of the filter is always for the suppression of asymmetrical interferences (magnetically compensated suppression). The second step is, dependant on application for symmetrical or asymmetrical interferences.

Application	symmetrical interferences: units with high repetitions of the switching processes, - switch mode P.S.U.s, - phase angle controller, - supply of universal motors, - behind transformers
-------------	---

Dimension drawing

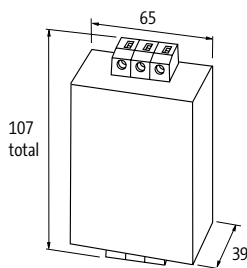

Murrelektronik Online Shop
onlineshop.murrelektronik.com/en

Notes

EMC filters

EMC FILTERS

1-phase, 2-stage

– DIN-rail mountable

Approvals:  **us**

MEF 1/2 AS

against asymmetrical interferences



Circuit diagram

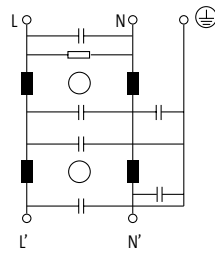

Order Data

	Art-No.
3 A	10470
6 A	10471
10 A	10472

Technical Data

Operating voltage	max. 250 V AC/300 V DC
Operating frequency	50...60 Hz
Consumption at 250 V AC	max. 5 mA
Overload current	18 × (IN t) max. 0.5 ms; 1.5 × (IN t) max. 1 min. (1 × per hour)

General data

Climatic category	25/085/21 (EN 60068-1)
Test isolation voltage	L - N: 2.7 kV DC, 2 s; L - L: 2.1 kV DC, 2 s (EN 60939-2)
Connection	Screw connection, touch protected
Mounting method	DIN-rail mountable TH35 (EN 60715)

Description

Functional description
The single phase 2-stage EMC filters MEF 1/2 are used in the range 0.1...30 MHz to suppress cable carried interference on mains and control cables. The best filter performance is achieved by using short connection wires (suggestion: earth connection < 10 cm) and the largest possible diameter. The EMC filters work bi-directionally (in both directions). The filters are for demanding applications. The filters are designed for use with fixed modules. One step of the filter is always for the suppression of asymmetrical interferences (magnetically compensated suppression). The second step is, dependant on application for symmetrical or asymmetrical interferences.

Application
asymmetrical interferences: - units with high switching frequency and repetition, - switch mode P.S.U.s, - in DC mains, - in front of transformers, - for frequency inverters

Dimension drawing

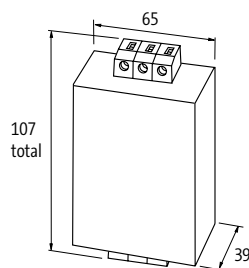

Murrelektronik Online Shop
onlineshop.murrelektronik.com/en

Notes

EMC FILTERS

3-phase, 1-stage

– DIN-rail mountable

– with neutral

Approvals:  

MEF 3/1 N

for universal applications



Circuit diagram

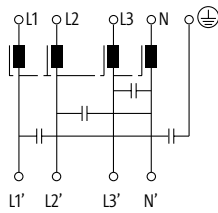

Order Data	Art-No.
3 A	10510
6 A	10511
10 A	10512
20 A	10513

Technical Data	
Operating voltage	max. 4 × 440 V AC
Operating frequency	50...60 Hz
Consumption at 250 V AC	max. 3 mA
Overload current	18 × (IN t) max. 0.5 ms; 1.5 × (IN t) max. 1 min. (1 × per hour)

General data	
Climatic category	25/085/21 (EN 60068-1)
Test isolation voltage	L - N: 2.7 kV DC, 2 s; L - L: 2.1 kV DC, 2 s (EN 60939-2)
Connection	Screw connection, touch protected
Mounting method	DIN-rail mountable TH35 (EN 60715)

Description	
Functional description	The 3-phase and one-stage EMC filters MEF 3/1 are used in the range 0.1...30 MHz and dampen interferences found in cables from the mains, supply units and control systems. They are suitable for TN-S, TN-CS, and TT networks. The best results are obtained with short connection cables (suggestion: earth connection < 10 cm) of the largest possible cross-section. The EMC filters are bi-directional. They reduce symmetrical and asymmetrical interferences that regularly appear with electronically controlled three phase units through mains influences.

Dimension drawing

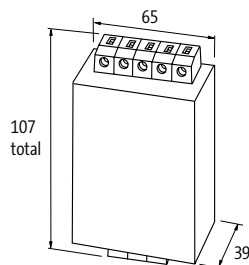

Murrelektronik Online Shop
onlineshop.murrelektronik.com/en

Notes

EMC FILTERS

3-phase, 1-stage

– with neutral

Approvals:

MEF 3/1 N HD

with increased damping



Circuit diagram

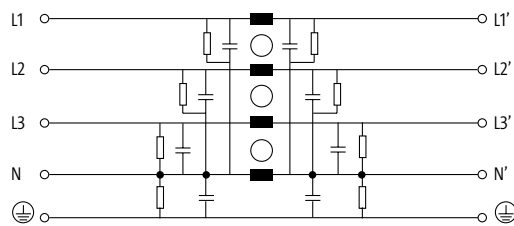

Order Data	H×W×D/kg	Art-No.
10 A	153×130×100/1.0	10571
18 A	153×130×100/1.0	10572
36 A	153×130×100/1.1	10574
72 A	153×118×125/1.6	10575
100 A	170×180×140/3.4	10577
135 A	170×180×140/4.5	10578

Accessories	Art-No.
Ground strap 16 mm ²	4000-71001-1620006
Ground strap 35 mm ²	4000-71001-3520006

Technical Data	
Operating voltage	max. 3 × 500 V AC
Operating frequency	50...60 Hz
Consumption at 250 V AC	max. 15 mA
Overload current	18 × (IN t) max. 0.5 ms; 1.5 × (IN t) max. 1 min. (1 × per hour)

General data	
Climatic category	25/085/21 (EN 60068-1)
Test isolation voltage	L - N: 3.3 kV DC, 2 s; L - L: 3.1 kV DC, 2 s
Mounting method	screw fixing, M6

Description	
Functional description	The 3-phase and one-stage EMC filters MEF 3/1 are used in the range 0.1...30 MHz and dampen interferences found in cables from the mains, supply units and control systems. They are suitable for TN-S, TN-C-S, and TT networks. The best results are obtained with short connection cables (suggestion: earth connection < 10 cm) of the largest possible cross-section. The EMC filters are bi-directional. They reduce symmetrical and asymmetrical interferences that regularly appear with electronically controlled three phase units through mains influences.

Dimension drawing

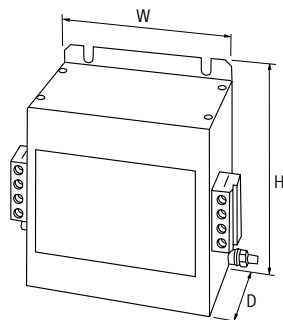

Murrelektronik Online Shop
onlineshop.murrelektronik.com/en

Notes

EMC FILTERS

3-phase, 1-stage

– Space saving book form

Approvals: 

MEF 3/1



Circuit diagram

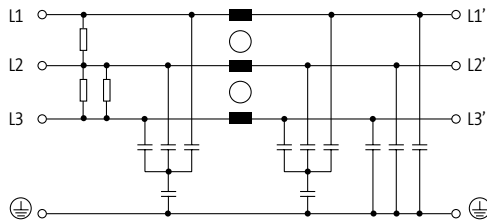

Order Data	HxWxD/kg	Art-No.
8 A	250x90x100/1.3 – GOST	10531
16 A	250x90x100/1.3 – GOST	10532
25 A	250x90x100/1.3 – GOST	10533
36 A	250x90x100/1.5	10534
50 A	250x90x100/1.7 – GOST	10535
80 A	270x85x135/2.2 – GOST	10537
110 A	270x90x150/3.2 – GOST	10538
180 A	380x120x170/5.1 – GOST	10539

Accessories	Art-No.
Ground strap 16 mm ²	4000-71001-1620006
Ground strap 35 mm ²	4000-71001-3520006

Technical Data	
Operating voltage	max. 3 × 600 V AC
Operating frequency	50...60 Hz
Overload current	18 × (I _N t) max. 0.5 ms; 1.5 × (I _N t) max. 1 min. (1 × per hour)
Consumption at 250 V AC	max. 10 mA

General data	
Climatic category	25/085/21 (EN 60068-1)
Test isolation voltage	L - N: 3.3 kV DC, 2 s; L - L: 3.1 kV DC, 2 s
Connection	Screw connection, touch protected
Mounting method	screw fixing

Description	
Functional description	The 3-phase and 1-1/2-stage EMC filters MEF 3/1-3/2 are used in the range 0.1...30 MHz and dampen interferences found in cables from the mains, supply units and control systems. They are suitable for TN-C and IT mains. The best results are obtained with short connection cables (suggestion: earth connection < 10 cm) of the largest possible cross-section. The EMC filters are bi-directional. They reduce symmetrical and asymmetrical interferences that often occur with frequency converters and switch mode power supplies.

Dimension drawing

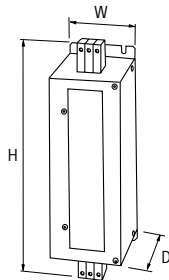

Murrelektronik Online Shop
onlineshop.murrelektronik.com/en

Notes

EMC filters

EMC FILTERS

3-phase, 2-stage

– Space saving book form

MEF 3/2



Approvals:

Circuit diagram

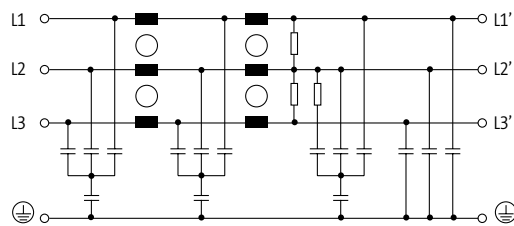

Order Data	HxWxD/kg	Art-No.
8 A	226x50x140/1.7	10550
12 A	226x50x140/1.7	10551
16 A	226x50x140/1.7	10552
25 A	226x50x140/1.7	10553
36 A	226x50x140/1.7	10554
50 A	295x70x177/3.7	10555
80 A	295x70x177/5.1	10556

Accessories	Art-No.
Ground strap 16 mm ²	4000-71001-1620006
Ground strap 35 mm ²	4000-71001-3520006

Technical Data	
Operating voltage	max. 3 × 500 V AC
Operating frequency	50...60 Hz
Overload current	18 × (IN t) max. 0.5 ms; 1.5 × (IN t) max. 1 min. (1 × per hour)
Consumption at 250 V AC	max. 15 mA

General data	
Climatic category	25/085/21 (EN 60068-1)
Test isolation voltage	L - N: 3.3 kV DC, 2 s; L - L: 3.1 kV DC, 2 s
Connection	Screw connection, touch protected
Mounting method	screw fixing

Description	
Functional description	The 3-phase and 1-/2-stage EMC filters MEF 3/1-3/2 are used in the range 0.1...30 MHz and dampen interferences found in cables from the mains, supply units and control systems. They are suitable for TN-C- and IT mains. The best results are obtained with short connection cables (suggestion: earth connection < 10 cm) of the largest possible cross-section. The EMC filters are bi-directional. They reduce symmetrical and asymmetrical interferences that often occur with frequency converters and switch mode power supplies.

Dimension drawing

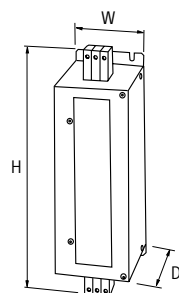

Murrelektronik Online Shop
onlineshop.murrelektronik.com/en

Notes

EMC SUPPRESSORS

SMALL DEVICE, BIG IMPACT

- Meets EMC guidelines
- Reduces voltage peaks
- Prevents coil short circuits

MURRELEKTRONIK SOLVES YOUR INTERFERENCE PROBLEMS

- Optimum interference results by adjusting your inductive load
- Prefabricated modules make it easy to install – reliably mounted every time
- Prevents operative failures and outages and increases availability
- Long service life of contacts and switching elements lower maintenance costs

THE RIGHT SUPPRESSION FOR ALL STANDARD INDUCTIVE LOADS

For Contactors

- Integrated system solutions for all standard contactors
- Universal suppressors for contactors or relays that snap in or stick to the mounting surface

For Motors

- Suppression directly next to the interference source or inside the motor terminal box
- Motor connector has 10 poles and an earth connection point with integrated suppressor module and pre-wired cable
- Integrated system solutions for direct connection to the contactor
- Universal suppressors snap in next to the motor contactor

For Valves

- Suppressors are simply mounted between valve base and valve plug instead of the flat gasket

EMC Suppressors

 <p>For Contactors ABB, General Electric, Eaton, Omron, Rockwell A. B., Schneider-Telemecanique, Siemens</p> <p>Universal Suppressors</p> <p><i>Page 1.9.1</i></p>	 <p>For Motors – Installation on the Motor RC 3 U, RC 3 R, RC 3 ST</p> <p><i>Page 1.9.14</i></p>
 <p>For Motors – Installation in the Cabinet RC 3 BUR, HRC 3 AS, RC 3 RT</p> <p><i>Page 1.9.17</i></p>	 <p>For Valves Form A, B, BI, C, CI</p> <p><i>Page 1.9.18</i></p>

EMC SUPPRESSORS

Suppressors for contactors



BC



A 16



A 110

Approvals:



Circuit diagram

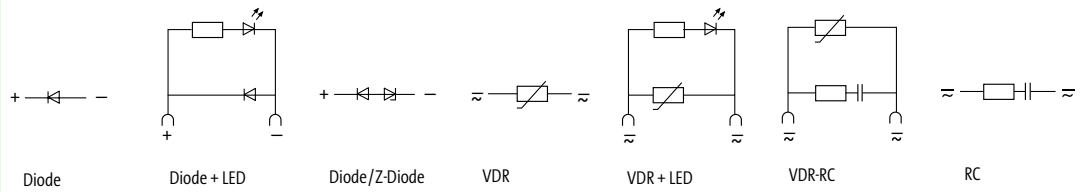

Appropriate contactors

B 6, BC 6, VB 6, KC 6

A 9...A 16

A 26...A 110

Ordering data

Voltage	Suppression	Approval	Art.-No.	Approval	Art.-No.	Approval	Art.-No.
24 ...240 V DC	Diode				26440		
24 V DC	Diode + LED						
	Diode/Z-Diode						
24 V AC/DC	VDR	CSA	26277				
	VDR + LED						
	RC						
48 V DC	Diode/Z-Diode						
48 V AC/DC	VDR	CSA	26278				
	RC						
110 V AC/DC	VDR						
	VDR + LED						
	VDR-RC						
	RC			CSA	21172	CSA	21173
230 V AC/DC	VDR	CSA	26079				
	VDR + LED						
	VDR-RC						
	VDR-RC + LED						
	RC			CSA	21172	CSA	21173
400 V AC/DC	VDR						
	RC						
415 V AC/DC	RC						

Technical data

Damping factor	~1,5 x U _N
Temperature range	-20...+70 °C
Material	plastic, flame retardant (UL 94)
Connection wires	self-securing cable forks plug contact

Dimension drawing

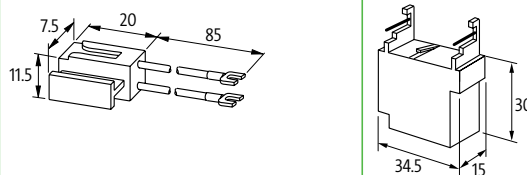

Notes

EMC SUPPRESSORS

Suppressors for contactors



Approvals:

M



CL



Circuit diagram

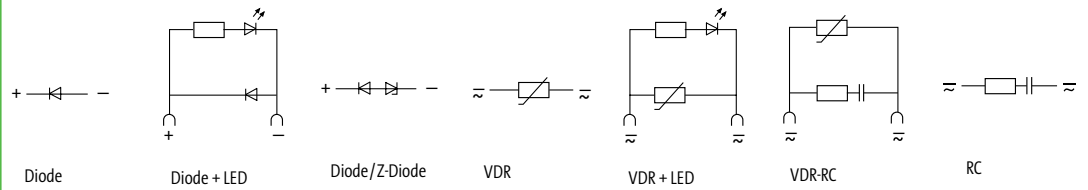

Appropriate contactors

M	CL00, 01, 02, 25	CL03, 04, 45	CL05...10
---	------------------	--------------	-----------

Ordering data

	Art.-No.	Art.-No.	Art.-No.	Art.-No.
Voltage				
Suppression				
24 ...240 V DC	2000-68300-110 0000	2000-69100-110 0000	2000-69200-110 0000	
24 V DC				
Diode				
Diode + LED				
Diode/Z-Diode				
24 V AC/DC	2000-68300-440 0000	2000-69100-440 0000	2000-69200-440 0000	2000-69100-440 0000
VDR				
VDR + LED				
RC	2000-68300-430 0000	2000-69100-430 0000	2000-69200-430 0000	2000-69101-430 0000
48 V DC				
Diode/Z-Diode				
48 V AC/DC	2000-68300-440 0000	2000-69100-440 0000	2000-69200-440 0000	2000-69100-440 0000
VDR				
RC	2000-68300-430 0000	2000-69100-430 0000	2000-69200-430 0000	2000-69101-430 0000
110 V AC/DC		2000-69100-740 0000	2000-69200-740 0000	2000-69100-740 0000
VDR				
VDR + LED				
VDR-RC				
RC		2000-69100-730 0000		
230 V AC/DC		2000-69100-242 0000	2000-69200-242 0000	
VDR				
VDR + LED				
VDR-RC				
VDR-RC + LED				
RC			2000-69200-232 0000	2000-69101-232 0000
400 V AC/DC		2000-69100-542 0000	2000-69200-542 0000	2000-69100-542 0000
VDR				
RC				
415 V AC/DC				
RC				

Technical data

Damping factor	$\sim 1,5 \times U_N$
Temperature range	-20...+70 °C
Material	plastic, flame retardant (UL 94)
Connection wires	plug contact

Dimension drawing

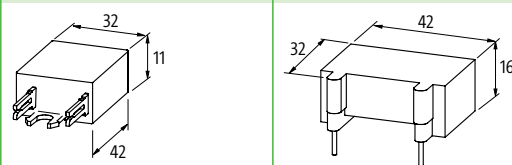

Notes

Art.-No. 2000-69200-110 0000 – also for CL05...10 DC-coils.

Suppressors for contactors

X-Start



Approvals:



Circuit diagram

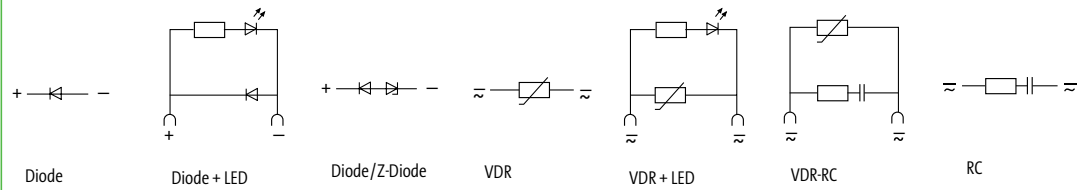

Appropriate contactors

		DIL M7...15 DIL MP20, DIL A	DIL M17...32	DIL M40...95
Ordering data		Art.-No.	Art.-No.	Art.-No.
Voltage	Suppression			
24 ...240 V DC	Diode			
24 V DC	Diode + LED			
	Diode/Z-Diode			
24 V AC/DC	VDR			
	VDR + LED	26013	26015	
	RC			
48 V DC	Diode/Z-Diode			
48 V AC	VDR + LED	26013	26015	
	RC			
110 V AC/DC	VDR			
	VDR + LED	26014		
	VDR-RC			
	RC	20007	20008	20009
230 V AC/DC	VDR			
	VDR + LED	26014		
	VDR-RC			
	VDR-RC + LED			
	RC	20007	20008	20009
400 V AC/DC	VDR			
	RC			

Technical data

Damping factor	~1,5 x U _N
Temperature range	-20...+70 °C
Material	plastic, flame retardant (UL 94)
Connection wires	plug contact

Dimension drawing

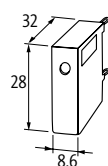

Notes

LED indicator for 24 V DC without suppression available on request.

EMC SUPPRESSORS

Suppressors for contactors



Approvals:



Circuit diagram

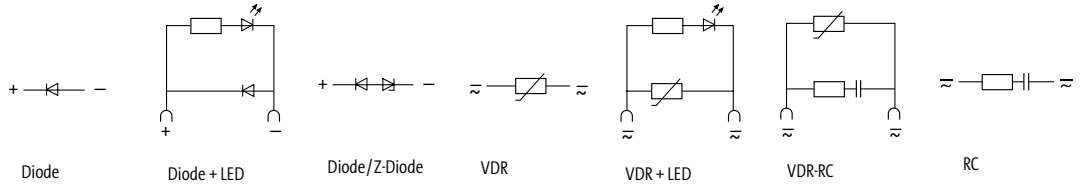

Appropriate contactors

DIL E...	DIL 3 - 4...M DIL 3 H, DIL 4 H	DIL 0 - 2...M DIL R...
----------	-----------------------------------	---------------------------

Ordering data

	Art.-No.	Art.-No.	Art.-No.
Voltage			Approval
24 ...240 V DC			26080
24 V DC			26081
24 V AC/DC			
48 V DC			
48 V AC/DC			
110V AC/DC			
230V AC/DC	21054 26086	21073	21028
400V AC/DC	21054	21073	21028

Technical data

Damping factor	$\sim 1,5 \times U_N$
Temperature range	-20...+70 °C
Material	plastic, flame retardant (UL 94)
Connection wires	self-securing cable forks / plug contact

Dimension drawing

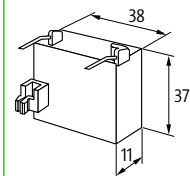
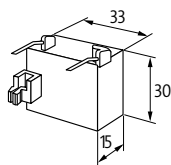
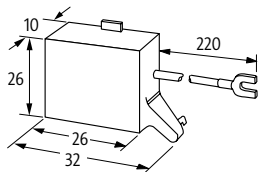

Notes

EMC SUPPRESSORS

Suppressors for contactors

OMRON



Approvals:



Circuit diagram

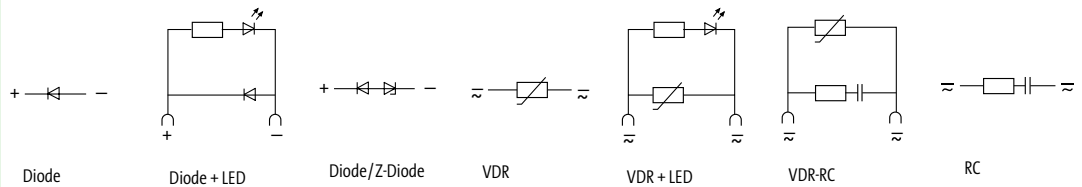

Appropriate contactors

J7KNA

J7KN

J7KN

Ordering data

		Art.-No.	Art.-No.	Art.-No.
Voltage	Suppression			Approval
24 ...240 V DC	Diode			
24 V DC	Diode + LED			
	Diode/Z-Diode			
24 V AC/DC	VDR			cURus / CSA
	VDR + LED			
	RC	2000-68800-230 0000	2000-69000-230 0000	26400
48 V DC	Diode/Z-Diode			
48 V AC	VDR			cURus / CSA
	RC			26401
110 V AC/DC	VDR			
	VDR + LED			
	VDR-RC			
	RC	2000-68800-730 0000		
230 V AC/DC	VDR			cURus / CSA
	VDR + LED			
	VDR-RC			
	VDR-RC + LED			
	RC	2000-68800-232 0000		
400 V AC/DC	VDR			cURus / CSA
	RC			26404

Technical data

Damping factor	~1,5 x U _N
Temperature range	-20...+70 °C
Material	plastic, flame retardant (UL 94)
Connection wires	self-securing cable forks

Dimension drawing

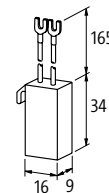
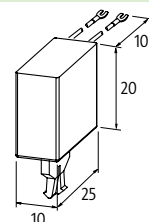
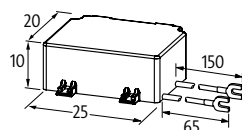

Notes

Further types on request.

EMC SUPPRESSORS

Suppressors for contactors



I00-M



I00-C



Approvals:

Circuit diagram

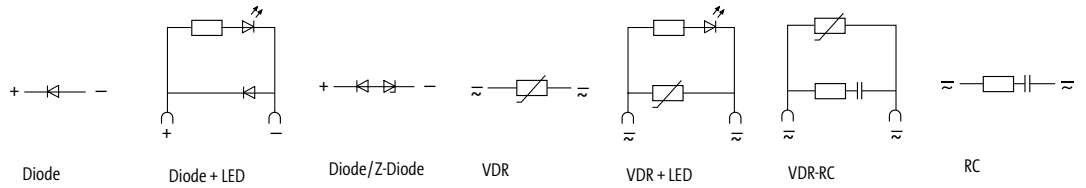

Appropriate contactors

I00 M

I00-C09...C85

Ordering data

Voltage	Suppression	Approval	Art.-No.	Art.-No.
24 ...240 V DC	Diode			cURus / CSA 2000-68200-110 0000
24 V DC	Diode + LED			
24 V AC/DC	Diode /Z-Diode			
	RC			cURus / CSA 2000-68200-430 0000
	VDR	cURus / CSA	26375	cURus / CSA 2000-68200-440 0000
48V AC/DC	RC			cURus / CSA 2000-68200-430 0000
	VDR			cURus / CSA 2000-68200-440 0000
110V AC/DC	VDR			cURus / CSA 2000-68200-740 0000
	VDR + LED			
	VDR-RC			
	RC			cURus / CSA 2000-68200-132 0000
230 V AC/DC	VDR	cURus / CSA	26378	cURus / CSA 2000-68200-242 0000
	VDR + LED			
	VDR-RC			
	VDR-RC + LED			
	RC	cURus / CSA	21143	cURus / CSA 2000-68200-132 0000
400V AC/DC	RC			cURus / CSA 2000-68200-532 0000
	VDR			cURus / CSA 2000-68200-542 0000

Technical data

Damping factor	$\sim 1,5 \times U_N$
Temperature range	-20...+70 °C
Material	plastic, flame retardant (UL 94)
Connection wires	ferrule ends plug contact

Dimension drawing

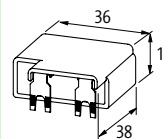
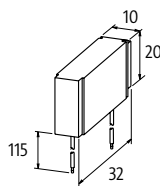

Notes

EMC SUPPRESSORS

Suppressors for contactors

S00

S0

SIEMENS



Approvals:



Circuit diagram

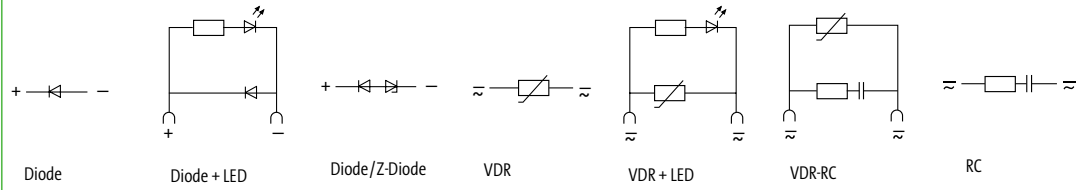

Appropriate contactors

3 RT 20.15/16/17/18

3 RT 20.25/26/27/28

Ordering data

		Art.-No.	Art.-No.
Voltage	Suppression		
24 ...240 V DC	Diode	2000-68500-110 0000	
24 V DC	Diode + LED		2000-68400-201 0000
	Diode/Z-Diode		
24 V AC/DC	VDR	2000-68500-440 0000	2000-68400-440 0000
	VDR + LED	2000-68500-441 0000	2000-68400-441 0000
	RC	2000-68500-430 0000	2000-68400-430 0000
48 V AC/DC	VDR		
	RC	2000-68500-430 0000	2000-68400-430 0000
110 V AC/DC	VDR	2000-68500-740 0000	2000-68400-740 0000
	VDR + LED	2000-68500-741 0000	2000-68400-741 0000
	VDR-RC		
	RC	2000-68500-730 0000	2000-68400-730 0000
230V AC/DC	VDR	2000-68500-242 0000	2000-68400-242 0000
	VDR + LED	2000-68500-247 0000	
	RC	2000-68500-232 0000	2000-68400-232 0000
400V AC/DC	VDR	2000-68500-542 0000	2000-68400-542 0000
	RC	2000-68500-532 0000	2000-68400-532 0000

Technical data

Damping factor	$\sim 1,5 \times U_N$
Temperature range	-20...+70 °C
Material	plastic, flame retardant (UL 94)
Connection wires	plug contact

Dimension drawing

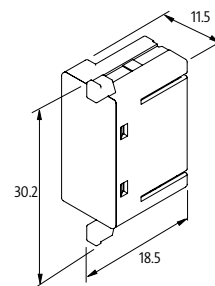
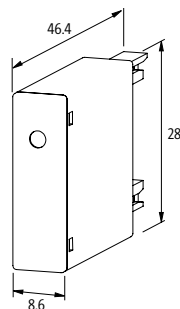

Notes

Suppressors for contactors

S2

S3

S6 - S12

SIEMENS



Approvals:



Circuit diagram

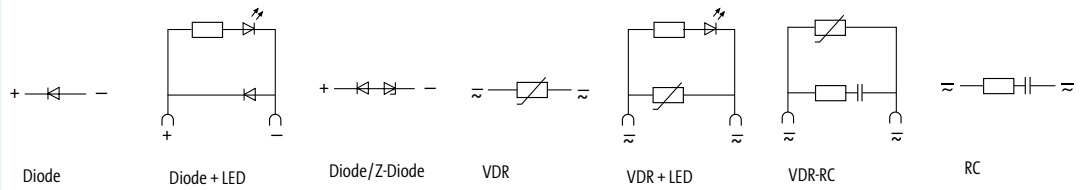

Appropriate contactors

3 RT 1.3/1.4

3 RT 1.5/6/7

Ordering data

Voltage		Suppression	Approval	Art.-No.	Approval	Art.-No.	Art.-No.
24 V DC		Diode + LED					
		Diode + Z-Diode + LED					
		Diode/Z-Diode			UR / CSA	26521	
24 V AC/DC		VDR			UR / CSA	26524	
		VDR + LED					
		VDR-RC	UR / CSA	21215			21220
48 V DC		Diode/Z-Diode					
48 V AC/DC		VDR					
		VDR-RC					21220
110 V AC/DC		VDR					
		VDR + LED					
		VDR-RC					
		RC					
230 V AC/DC		VDR			UR / CSA	26526	
		VDR + LED					
		VDR-RC					
		RC	UR / CSA	21217			21222
400 V AC/DC		VDR					

Technical data

Damping factor	~1,5 x U _N
Temperature range	-20...+70 °C
Material	plastic, flame retardant (UL 94)
Connection wires	plug contact

Dimension drawing

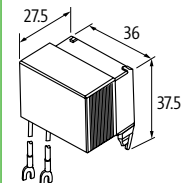
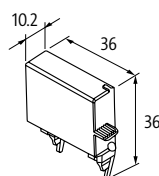

Notes

EMC SUPPRESSORS

Suppressors for contactors

SIEMENS

Approvals:



S0 4



S0 1



3 TF/L-3 TF



Circuit diagram

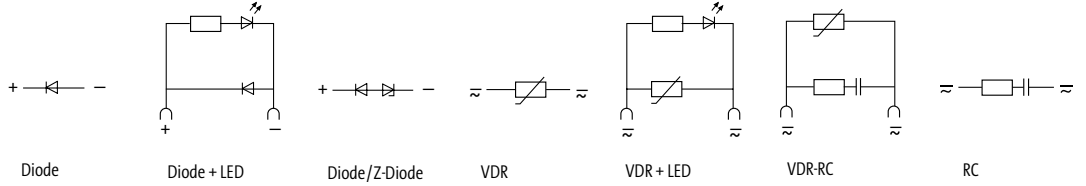

Appropriate contactors

3 TH 3/4
3 TF 30...35, 3 TF 40...45

3 TH 3/4/8, 3 TF 30...45
3 TB 40...3 TB 44

3 TH 2, 3 TF 2
3 TH 20, 3 TF 20

Ordering data

Art.-No.

Art.-No.

Art.-No.

Voltage	Suppression	Approval	Art.-No.	Approval	Art.-No.	Approval	Art.-No.
24...240 V DC	Diode		26588	UR / CSA	26283	cURus / CSA	26036
24V DC	Diode + LED			UR / CSA	26051	cURus / CSA	26530
	Diode/Z-Diode			UR / CSA	26051	cURus / CSA	26034
24V AC/DC	VDR	CSA	26576				
	VDR + LED			UR / CSA	22050		
	RC						
48V DC	Diode/Z-Diode						
48V AC/DC	VDR	CSA	26576			cURus / CSA	26038
	RC			UR / CSA	22051		
110 V AC/DC	VDR						
	VDR + LED						
	VDR-RC						
	RC			UR / CSA	22051		
230 V AC/DC	VDR	CSA	26578	UR / CSA	26317	cURus / CSA	26039
	VDR + LED						
	VDR-RC						
	RC			UR / CSA	22052		
	RC			UR / CSA	22054		
400 V AC/DC	VDR						
	RC			UR / CSA	22054		

Technical data

Damping factor	$\sim 1,5 \times U_N$
Temperature range	-20...+70 °C
Material	plastic, flame retardant (UL 94)
Connection wires	self-securing cable forks

Dimension drawing

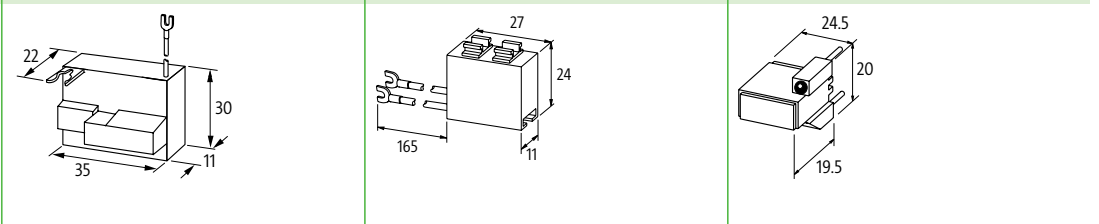

Notes

EMC SUPPRESSORS

Suppressors

– universal

AO

AD

CF



Approvals:



Circuit diagram



Diode

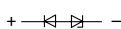

Diode/Z-Diode

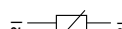

VDR

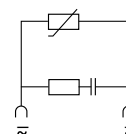

VDR-RC



RC

Appropriate contactors

universal

universal

universal

Ordering data

Ordering data		Art.-No.	Art.-No.	Art.-No.	sugg. coil valves		
Voltage	Suppression	Approval	Approval	Approval	AO	AD	CF
Max. 240 V DC	Diode	CSA 26001			15 W		
24 V DC	Z-Diode	CSA 26120	CSA 26073		25 W	75 W	
24 V AC/DC	VDR	cURus / CSA 26180	CSA 26720		50 VA/W	200 VA/W	
	RC			CSA 20680			20 VA
48 V AC/DC	VDR	cURus / CSA 26181			70 VA/W		
	RC	cURus / CSA 20001	cURus / CSA 20013		15 VA	15 VA	
110 V AC/DC	VDR	cURus / CSA 26182	CSA 26722		100 VA/W	200 VA/W	
	VDR-RC						
	RC						
230 V AC/DC	VDR	cURus / CSA 26183	CSA 26723		200 VA/W	200 VA/W	
	VDR	cURus / CSA 26184			200 VA/W		
	RC		CSA 20014	CSA 20682		25 VA	20 VA
	RC	cURus / CSA 20002	cURus / CSA 20010	CSA 20683	15 VA	75 VA	20 VA
	RC		cURus / CSA 20011	CSA 20687		100 VA	50 VA
400 V AC/DC	VDR		CSA 26724			200 VA/W	
	RC	cURus / CSA 20004	cURus / CSA 20012	CSA 20688	15 VA	100 VA	50 VA
	RC						

Technical data

Damping factor	ca. 1,5
Temperature range	-20...+70 °C
Material	plastic, flame retardant (UL 94)
Connection wires	self-securing cable forks

Dimension drawing

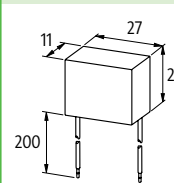
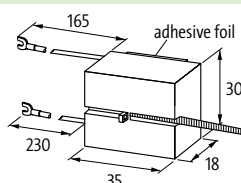
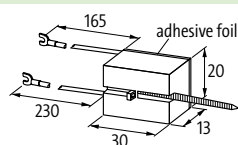

Form 1

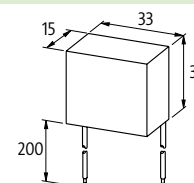

²⁾ Form 2

Notes

Art.-No. 26184 – up to 300 V AC/DC

EMC SUPPRESSORS

Suppressors

– universal

Approvals:



H



RC-BUG 2



BU + UB



Circuit diagram

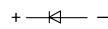

Diode

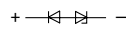

Diode/Z-Diode

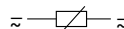

VDR

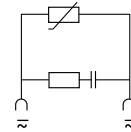

VDR-RC

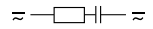

RC

Appropriate contactors

universal

universal

universal

Ordering data

Ordering data		Art.-No.	Art.-No.	Art.-No.	sugg. coil valves		
Voltage	Suppression	Approval	Approval	Approval	H	RC-BUG 2	BU + UB
24 ...240 V DC	Diode	CSA	26097	CSA	26020	25 W	50 W
24 V DC	Z-Diode	CSA	26095	CSA	26130	25 W	50 W
24 V AC/DC	VDR	cURus / CSA	26090	cURus / CSA	26150	50 VA/W	50 VA/W
	RC						
48 V AC/DC	VDR						
	RC	CSA	20100			15 VA	
110 V AC/DC	VDR						
	VDR-RC						
	RC			CSA	26613		146 VA
230 V AC/DC	VDR						
	VDR			CSA	26619	cURus / CSA	26155
	RC	CSA	20101	CSA	26614	CSA	20031
	RC	CSA	20102	CSA	20033	15 VA	146 VA
	RC	CSA	20103	CSA	20034	25 VA	25 VA
	RC	CSA		CSA		75 VA	25 VA
400 V AC/DC	VDR						
	RC			CSA	26615	CSA	20032
	RC			CSA	26616		146 VA
							146 VA

Technical data

Damping factor	ca. 1,5
Temperature range	-20...+70 °C
Material	plastic, flame retardant (UL 94)
Mounting method	DIN-rail mounting (EN 60715) with adapter ASA Art.-No. 20900, DIN-rail mounting (EN 60715)
Connection wires	self-securing cable forks

Dimension drawing

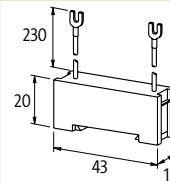
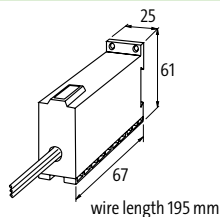
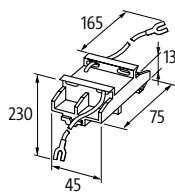

Notes

Art.-No. 20034 – without adapter, can be directly snapped onto DIN-rail, ASA adapter Art.-No. 20900 included in delivery.
Art.-No. 26616 – up to 600 V AC/DC

EMC SUPPRESSORS

Suppressors for motors

Mounting methods:

- on the motor terminal box
- inside the motor terminal box
- inside the distribution box
- on 35 mm DIN-rail acc. to EN 60715

Approvals:



RC 3 U

With M16 x 1,5



RC 3 BU



RC 3 BUG



Circuit diagram

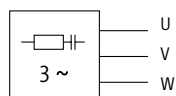

RC

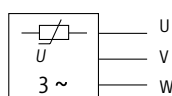

VDR

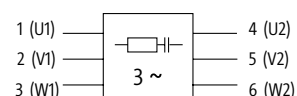

RC(1) per phase

Ordering data		Art.-No.	Art.-No.	Art.-No.
Voltage	Motor rating	Suppression/Approval	Suppression/Approval	Suppression/Approval
3 x 400 V AC	4 kW	RC	23022	RC/cURus 23050
	4 kW			VDR 23115
	4 kW			VDR/cURus 23115
	7,5 kW			VDR/cURus 23115
	10 kW	RC	23011	VDR/cURus 23118
	10 kW	RC-per phase	23043	
	20 kW			VDR/cURus 23118
3 x 575 V AC	4 kW			RC/cURus 23050
	7,5 kW	RC/cURus	23035	
	20 kW			
	45 kW			
3 x 690 V AC	4 kW			RC/v 23056
	7,5 kW			
	20 kW			

Technical data	
Frequency	for RC: 50...60 Hz for VDR: 10...400 Hz
Material	plastic, flame retardant (UL 94)
Potting compound	2-component epoxy
Temperature range	-20...+60 °C
Connection method	approx. 500 mm PVC cable 3 x 0,75 mm ² or 7 x 0,75 mm ²
	approx. 200 mm single core 0,35 mm ² ; Art.-No. 23056 0,5 mm ² with self-securing M4 cable forks M4
	approx. 500 mm single core 1 mm ²

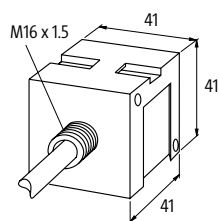

For DIN-rail mounting use
2 x **Art.-No. 20900** adapter feet

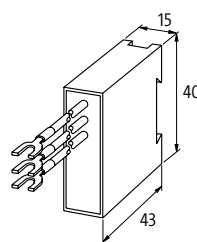

For DIN-rail mounting use
1 x **Art.-No. 20900** adapter feet

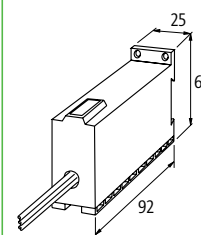

For DIN-rail mounting use
2 x **Art.-No. 20900** adapter feet

Notes
Do not use RC motor suppressors on variable frequency drives. 1 x Art.-No. 23103, 23043 required per phase.

EMC Suppressors

EMC SUPPRESSORS

Suppressors for motors

Mounting methods:

- with M16 x 1.5 and M20 x 1.5
- on the motor terminal box with plug connectors

Approvals:



RC 3 R

With M16 x 1.5 screw



RC 3 R

With M16 x 1.5 screw

RC 3 RG

With M20 x 1.5 screw



Circuit diagram

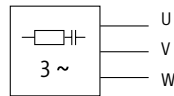

RC

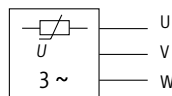

VDR

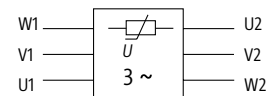

VDR-(1) per phase

Ordering data

Ordering data		Art.-No.	Art.-No.	Art.-No.
3 x 400 V AC	Motor rating	Suppression/Approval	Suppression/Approval	Suppression/Approval
	4 kW	VDR/cURus	23170	RC/cURus
	4 kW			
	4 kW			
	7,5 kW	VDR	23171	
	10 kW			VDR
3 x 575 V AC	4 kW	VDR/cURus	23172	RC/cURus
	7,5 kW	VDR/cURus	23173	
	10 kW			VDR
	20 kW			VDR
	20 kW			VDR per phase
	20 kW			VDR
3 x 690 V AC	7,5 kW	VDR	23174	
	20 kW			VDR

Technical data

Frequency	for RC: 50...60 Hz		for VDR: 10...400 Hz
Material	plastic, flame retardant (UL 94)		
Potting compound	2-component epoxy		
Temperature range	-20...+60 °C		
Connection method	approx. 100 mm single core 0,5 mm ²		approx. 150 mm single core 1 mm ²
Ring terminals	isolated M6	isolated M4	isolated M6

Dimension drawing

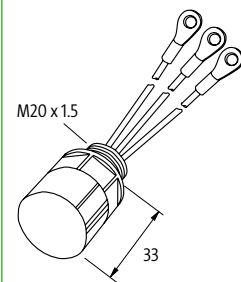
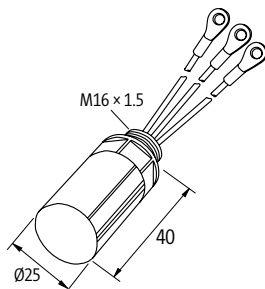

Notes

Do not use RC motor suppressors on variable frequency drives.

Art.-No. **23174** – wire diameter 1.5 mm².

EMC SUPPRESSORS

Suppressors for motors

Mounting methods:

– on the motor terminal box with plug connectors

Approvals:



RC 3 ST

Connector with cable and integrated motor suppression
Cable outlet in the back



RC 3 ST

Connector with cable and integrated motor suppression
Cable outlet (right angle)



Circuit diagram

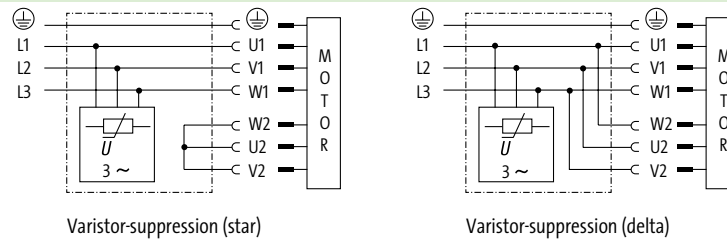

Varistor-suppression (star)

Varistor-suppression (delta)

Ordering data

Voltage	Motor rating	Cable length	Suppression	Art.-No.	Suppression	Art.-No.
max.	5,5 kW	5 m	VDR/star	236139	VDR/star	236148
3 x 575 V AC	5,5 kW	8 m	VDR/star	236141	VDR/star	236149
	5,5 kW	10 m	VDR/star	236142		

Technical data

Frequency	10...400 Hz	
Plug connector	females, 10-pole + PE	
Housing	aluminium pressure diecasting	
Temperature range	-20...+60 °C	
Connection method	PUR cable black, 4 x 1.5 mm ² ; numbered wires, halogen free	PUR cable black, 4 x 1.5 mm ² ; numbered wires, DESINA® compliant

Dimension drawing

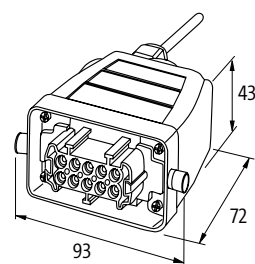

(without compression gland)

Notes

EMC SUPPRESSORS

Suppressors for motors

Mounting methods:

- on 35 mm DIN-rail acc. to EN 60715
- bolted together, stacked
- DIN-rail mounting under the control gear

Approvals:



HRC 3



HRC 3 K



RC 3 BUC

Connects onto Siemens SIRIUS 3 RT 20 contactors, with screw terminal



RC 3 BUC

Connects onto Siemens SIRIUS 3 RT 20 contactors, with spring clamp terminal



Circuit diagram

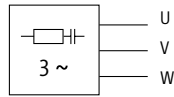

RC

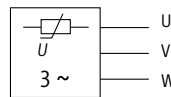

VDR

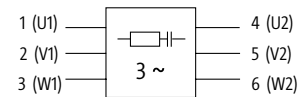

RC(1) per phase

Ordering data		Art.-No.	Art.-No.	Art.-No.	Art.-No.	
3 x 400 V AC	Motor rating	Suppression/Approval	Suppression/Approval	Suppression/Approval	Suppression/Approval	
	4 kW	RC/cURus	23004	RC	23005	
	4 kW	RC/cURus	233463			
	5,5 kW			RC/cURus	236082	
	7,5 kW				RC/cURus	23220
	10 kW	RC/cURus	23002	RC	23003	
	20 kW	RC-per phase/cURus	23009			
3 x 500 V AC +10 %	20 kW	VDR/cURus	23015			
	4 kW	RC/cURus	23000	RC	23001	
3 x 575 V AC	5,5 kW			RC/cURus	236082	
	7,5 kW	RC/cURus	23006	RC	23007	
	7,5 kW	RC/cURus	230563		RC/cURus	23220
	10 kW	VDR/cURus	23016			
	20 kW			RC	23018	
3 x 690 V AC	10 kW	RC	23017			

Technical data

Frequency	for RC: 50...60 Hz, for VDR: 10...400 Hz			
Material	plastic, flame retardant (UL 94)			
Potting compound	2-component epoxy			
Temperature range	-20...+60 °C			
Connection method	approx. 250 mm s. core (Art.-No. 23000: 300 mm) 0,5 mm ² (Art.-No. 23000: 1,5 mm ²) with self-securing M4 cable forks	3-pole terminal 2 x (0,75...2,5 mm ²) M4	wire (solid core) 2,0 mm ²	wire with ferrule ends 2,0 mm ²

Dimension drawing

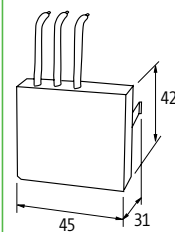
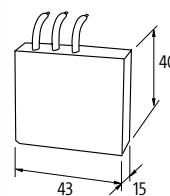
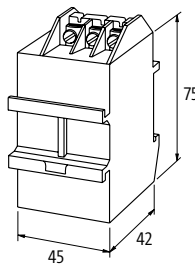
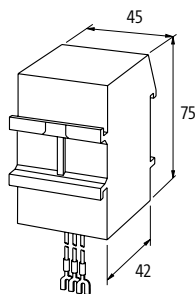

Notes

Do not use RC motor suppressors on variable frequency drives.
Art.-No. 233463 and 230563 – with ferrule ends.

EMC SUPPRESSORS

Suppressors for motors

Mounting methods:

- DIN-rail mounting under the control gear
- fixes onto contactors
- available with integrated coil suppression

Approvals:



HRC 3 AS



RC 3 RT

Connects onto Siemens SIRIUS 3 RT 10, 3 RT 20 contactors with screw terminal



Circuit diagram

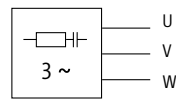

RC

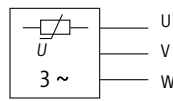

VDR

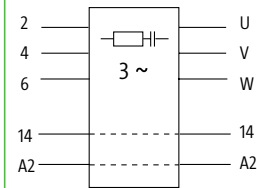

Appropriate contactors

Motor contactors up to 5.5 kW from Siemens, Moeller, Sprecher + Schuh etc.

Siemens 3 RT 10

Ordering data

		Art.-No.	Art.-No.	Art.-No.
Voltage	Motor rating	Suppression motor + coil	Suppression motor + coil	Suppression/approval
3 x 400 V AC	5,5 kW	RC 23160	VDR 23163	RC/cURus / CSA 23180
	5,5 kW	RC + Diode 23151		
3 x 575 V AC	5,5 kW	RC 23161	VDR 23164	RC/cURus / CSA 23181
	5,5 kW		VDR + Diode 23157	

Technical data

Suppression coil	for RC: 230 V AC/20 VA, for RC + Diode: 24...230 V DC/36 W
Frequency	for RC: 50...60 Hz, for VDR: 10...400 Hz
Material	plastic, flame retardant (UL 94)
Temperature range	-20...+60 °C
Connection method	ferrules, load side securely fixed

Dimension drawing

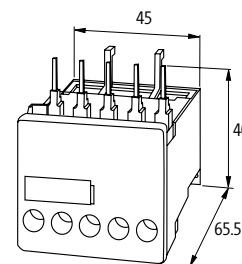
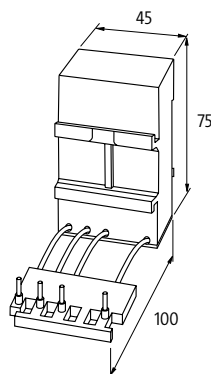

Notes

Do not use RC motor suppressors on variable frequency drives.

EMC SUPPRESSORS

Suppressors for valves

- with LED
- with suppression

VBS

Form A
Pin spacing 18 mm
EN 175301-803 (ISO 4400)



LBS

Form B1 Industrial Standard
Pin spacing 11 mm



Circuit diagram

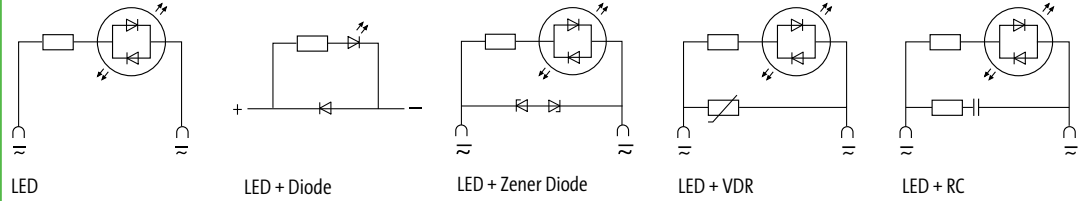

Ordering data

Voltage	Suppression	Art.-No.	Art.-No.	Switch off delay time [ms]	Switch off voltage peak [V]	Valve hold-on rating [W/ VA]
24 V DC	LED + Diode	¹⁾ 3124021	3124221	200	1	50
	LED	¹⁾ 3124015	3124215	-	-	50
	LED + Z-Diode	¹⁾ 3124033	3124233	20	55	100
	LED + VDR	¹⁾ 3124048	3124248	15	45	50
	LED + RC	3124068		20	105	10
	LED + RC		3124269	20	70	20
48 V AC/DC	LED	¹⁾ 3124017		-	-	50
	LED + VDR	¹⁾ 3124052		10	75	100
	LED + RC	²⁾ 3124071		20	90	30
110 V AC/DC	LED	3124018		-	-	50
	LED + VDR	3124046		10	235	100
	LED + RC	3124070		20	250	10
	LED + RC	²⁾ 3124072		20	250	25
230 V AC/DC	LED	3124016	3124216	-	-	50
	LED + VDR	3124049	3124249	15	360	100
	LED + RC	3124063	3124263	20	300	10
	LED + RC	²⁾ 3124064		20	300	25

Technical data

Supply indicator	LED yellow
Contact material	silvered bronze
Protection	IP65 when fully mounted
Material	polyamide black, flame retardant, temperature resistant up to 130 °C
Temperature range	-20...+60 °C

Dimension drawing

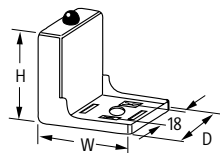

Housing H x W x D: 37 x 45 x 30 mm
¹⁾Housing H x W x D: 37 x 39 x 30 mm
²⁾Housing H x W x D: 37 x 53 x 33 mm
 0° and 180° version on request

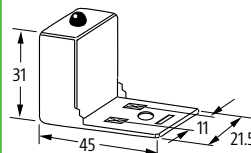

Note PIN arrangement (PE at cable outlet of connector)
 180° version on request

Notes

Do not use plug gasket when fitting adapter. Other LED colors on request.
 For double valves the VA 2 series is suitable (please inquire). At Art.-No. 3124021 and 3124221 polarity dependent

Suppressors for valves

- with LED
- with suppression

DAB/PBS

Form B/BI
Pin spacing 10/11 mm
EN 175301-803 (ISO 6952)



MVK/MVT

Form C/CI
Pin spacing 8/9.4 mm
EN 175301-803 (ISO 6952)



Circuit diagram

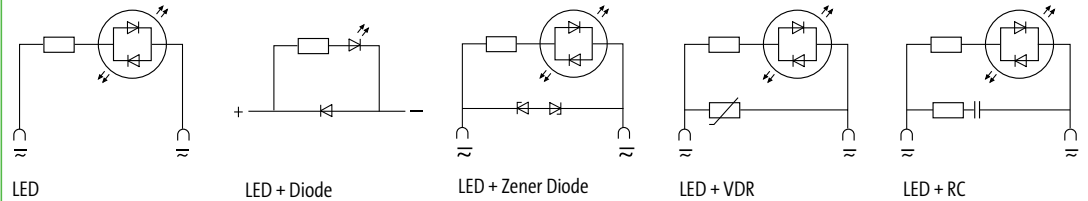

Ordering data		Art.-No.	Art.-No.	Art.-No.	Art.-No.	Switch off delay time	Switch off voltage peak	Valve hold-on rating
Voltage	Suppression	Form B	Form BI	Form C	Form CI	[ms]	[V]	[W/VA]
24 V DC	LED + Diode	3124871	3124121			200	1	50
24 V AC/DC	LED	3124875	3124115	3124811	3124815	-	-	50
	LED + Z-Diode	3124873	3124133	3124833	3124832	20	55	100
	LED + VDR		3124148			15	45	50
	LED + RC		3124169			20	70	20
110 V AC/DC	LED + RC		3124170			20	250	10
230 V AC/DC	LED		3124116			-	-	50
	LED + VDR					15	360	100
	LED + RC		3124163			20	300	10

Technical data

Supply indicator	LED yellow
Contact material	silvered bronze
Protection	IP65 when fully mounted
Material	polyamide black, flame retardant, temperature resistant up to 130 °C
Temperature range	-20...+60 °C

Dimension drawing

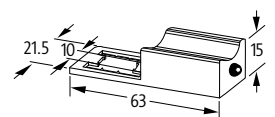

Suitable for 0° and 180° installation

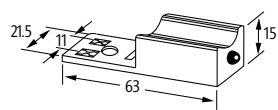

Note PIN arrangement
(PE at cable outlet of connector)
180° version on request

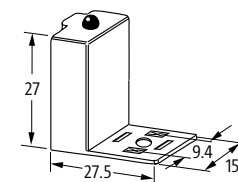
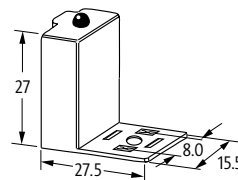

0° and 180° version on request

Notes

Do not use plug gasket when fitting adapter. Other LED colors on request. Right-angle housing version with 10 mm pin spacing (DAR/DARU), on request. At Art.-No. **3124871** and **3124121** polarity dependent.



RELAYS / SAFETY RELAYS INCREDIBLY VERSATILE

- Over 600 different modules ready for all applications
- Push-In technology, spring clamps or screw terminals available
- Worldwide approvals

TWICE AS SMALL, TWICE AS FAST!

Each system includes different kinds of active interface modules. Relay modules are used to separate two different potential levels. The control side is galvanically isolated from the load/contact side and should be protected from the wrong voltage. These interfaces adjust the different signal levels to work with the existing system.

With MIRO SAFE+, Murrelektronik offers safe switching devices for a wide range of safe industrial applications. They are the perfect solution to reach high safety standards – up to performance level e (PLe) according to EN 13849-1. **With MIRO SAFE+ you can design many different safety applications like: emergency stops, guard doors, two hand monitoring, light curtains, and safety magnet switch monitoring.**

Relays



Relay 6.2 mm
• Output relay
• Input relay

Page 1.10.1



Relay 12.4 mm
• Output relay
• Input relay

Page 1.10.8



Relay 22.5 mm
• Output relay
• Input relay

Page 1.10.17



Accessories

Page 1.10.29

Safety Relays



Safety Relay 22.5 / 45 mm
• MIRO SAFE+

Page 1.10.21

RELAYS / SAFETY RELAYS

Terminal relay

– with bridge system

MIRO 6.2

Output relay
1 NO/NC contact
Screw terminals



MIRO 6.2

Output relay
1 NO/NC contact
Spring clamp terminals



MIRO 6.2

Output relay
1 NO contact
Screw terminals



MIRO 6.2

Output relay
1 NO contact
Spring clamp terminals



Approvals:

Circuit diagram

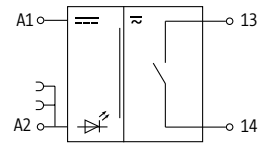
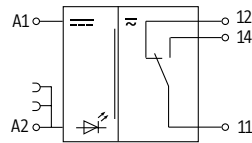

Order Data

	Art-No.	Art-No.	Art-No.	Art-No.
12 V DC (10...15 V DC - 20 mA)	52050	6652050		
24 V DC (19.2...30 V DC - 14 mA)	CCC 52000	CCC 6652000	CCC 52002	CCC 6652002
24 V DC (19.2...30 V DC - 17 mA)	CCC 52001	CCC 6652001	CCC 52015	CCC 6652015

Switching capacity (EN 60947-5-1)

AC-12	6 A (24 V AC; 110 V AC; 230 V AC)
AC-15	3 A (24 V AC; 110 V AC; 230 V AC)
DC-13	1 A (24 V DC); 0.2 A (110 V DC); 0.1 A (230 V DC)

Input

LED display LED (green)

Output

Switching voltage	max. 250 V AC/DC
Switching current per output	max. 6 A
Min. load current	10 mA (12 V DC)
Power rating (voltage dependent)	max. 1500 VA/120 W
Switching frequency	max. 10 Hz
Contact material	Ag Sn O2
Energize/release/contact bounce time	10/15/1.5 ms

General data

Mech./ elect. life	20.000.000 switching cycles/load dependent
Test isolation voltage	4 kV; safe separation (EN 60947-1)
Temperature range	-20...+55 °C
Mounting method	DIN-rail mountable (EN 60715)

Dimension drawing

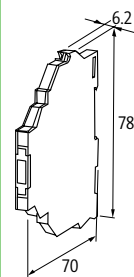
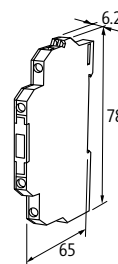
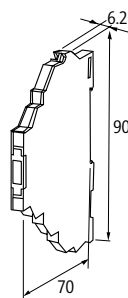
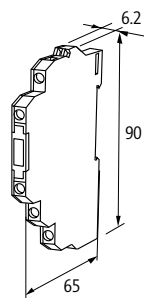

Murrelektronik Online Shop
onlineshop.murrelektronik.com/en

Notes

For inductive loads we recommend EMC suppressors connected parallel to the coil

RELAYS / SAFETY RELAYS

Terminal relay

– with bridge system

Approvals:  

MIRO 6.2

Output relay
1 NO/NC contact
Screw terminals



MIRO 6.2

Output relay
1 NO/NC contact
Spring clamp terminals



Circuit diagram

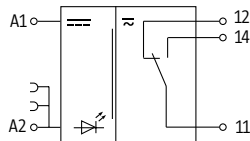

Order Data	Art-No.	Art-No.
48 V DC (40...53 V DC - 12 mA)	52020	6652020
110 V AC/DC (95...121VAC/DC - 4 mA)	52030	6652030
230 V AC/DC (195...253 V AC/DC - 3 mA)	52040	6652040

Switching capacity (EN 60947-5-1)

AC-12	6 A (24 V AC; 110 V AC; 230 V AC)
AC-15	3 A (24 V AC; 110 V AC; 230 V AC)
DC-13	1 A (24 V DC); 0.2 A (110 V DC); 0.1 A (230 V DC)

Input

LED display LED (green)

Output

Switching voltage	max. 250 V AC/DC
Switching current per output	max. 6 A
Min. load current	10 mA (12 V DC)
Power rating (voltage dependent)	max. 1500 VA/120 W
Switching frequency	max. 10 Hz
Contact material	Ag Sn O ₂
Energize/release/contact bounce time	10/15/1.5 ms

General data

Mech./ elect. life	20.000.000 switching cycles/load dependent
Test isolation voltage	4 kV; safe separation (EN 60947-1)
Temperature range	-20...+55 °C
Mounting method	DIN-rail mountable (EN 60715)

Dimension drawing

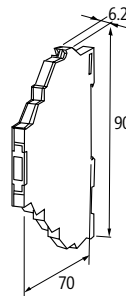
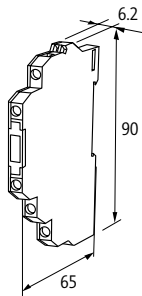

Murrelektronik Online Shop
onlineshop.murrelektronik.com/en

Notes

For inductive loads we recommend EMC suppressors connected parallel to the coil

RELAYS / SAFETY RELAYS

Terminal relay

– with bridge system

– Hand-O-Auto

MIRO 6.2

Output relay
1 NO contact
Screw terminals



MIRO 6.2

Output relay
1 NO contact
Spring clamp terminals



MIRO 6.2

Output relay
1 NO contact
Screw terminals



Circuit diagram

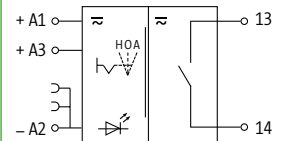
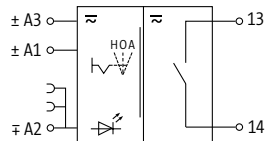

Order Data

24 V AC/DC (19.2...30 V AC/DC - 17 mA)

cURus, cCSAus, CCC

Art-No.

52007

cURus, cCSAus, CCC

Art-No.

6652007

Art-No.

526010

24 V AC/DC (19.2...28 V AC/DC - 7 mA)

Switching capacity (EN 60947-5-1)

AC-12 6 A (24 V AC; 110 V AC; 230 V AC)
AC-15 3 A (24 V AC; 110 V AC; 230 V AC)
DC-13 1 A (24 V DC); 0.2 A (110 V DC); 0.1 A (230 V DC)

Input

LED display

LED (green)

LED (green): auto mode; LED (red): manual mode

Output

Switching voltage max. 250 V AC/DC
Switching current per output max. 6 A
Min. load current 10 mA (12 V DC)
Power rating (voltage dependent) max. 1500 VA/120 W

Switching frequency

max. 10 Hz

Contact material

Ag Sn O₂

Energize/release/contact bounce time

10/15/1.5 ms

8/20/2 ms

General data

Mech./ elect. life 20.000.000 switching cycles/load dependent
Test isolation voltage 4 kV; safe separation (EN 60947-1)
Temperature range -20...+55 °C
Mounting method DIN-rail mountable (EN 60715)

Dimension drawing

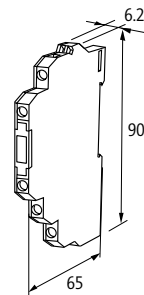
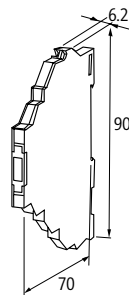
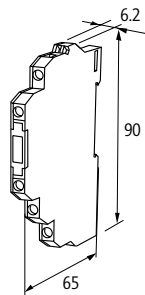

Murrelektronik Online Shop
onlineshop.murrelektronik.com/en

Notes

For inductive loads we recommend EMC suppressors connected parallel to the coil

RELAYS / SAFETY RELAYS

Terminal relay

– with bridge system

– Isolation function in output circuit



MIRO 6.2

Output relay
1 NO/NC contact
Screw terminals



MIRO 6.2

Output relay
1 NO/NC contact
Spring clamp terminals



Circuit diagram

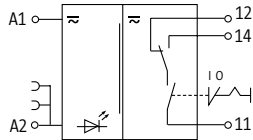

Order Data	Art-No.	Art-No.
24 V AC/DC (19.2...30 V AC/DC - 17 mA)	52010	6652010

Switching capacity (EN 60947-5-1)	
AC-12	6 A (24 V AC; 110 V AC; 230 V AC)
AC-15	3 A (24 V AC; 110 V AC; 230 V AC)
DC-13	1 A (24 V DC); 0.2 A (110 V DC); 0.1 A (230 V DC)

Input	
LED display	LED (green)
Output	
Switching voltage	max. 250 V AC/DC
Switching current per output	max. 6 A
Min. load current	10 mA (12 V DC)
Power rating (voltage dependent)	max. 1500 VA/120 W
Switching frequency	max. 10 Hz
Contact material	Ag Sn O ₂
Energize/release/contact bounce time	10/15/1.5 ms

General data	
Mech./ elect. life	20.000.000 switching cycles/load dependent
Test isolation voltage	4 kV; safe separation (EN 60947-1)
Temperature range	-20...+55 °C
Mounting method	DIN-rail mountable (EN 60715)

Dimension drawing

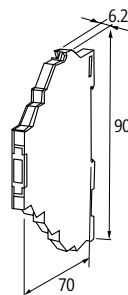
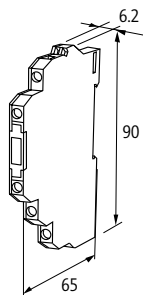

Murrelektronik Online Shop
onlineshop.murrelektronik.com/en

Notes	For inductive loads we recommend EMC suppressors connected parallel to the coil
-------	---

RELAYS / SAFETY RELAYS

Terminal relay

MIRO 6.2

Input relay
1 NO/NC contact
Screw terminals



MIRO 6.2

Input relay
1 NO/NC contact
Spring clamp terminals



Approvals:

Circuit diagram

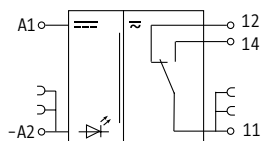

Order Data

24 V DC (19.2...30 V DC - 14 mA)

Art-No.

52005

Art-No.

6652005

24 V AC/DC (19.2...30 V AC/DC - 17 mA)

52003

6652003

Switching capacity (EN 60947-5-1)

AC-12	6 A (24 V AC; 110 V AC; 230 V AC)
AC-15	3 A (24 V AC; 110 V AC; 230 V AC)
DC-13	1 A (24 V DC); 0.2 A (110 V DC); 0.1 A (230 V DC)

Input

LED display LED (yellow)

Output

Switching voltage	max. 30 V AC/36 V DC
Switching current per output	max. 50 mA
Min. load current	1 mA (12 V DC)
Power rating (voltage dependent)	max. 1500 VA/120 W
Switching frequency	max. 10 Hz
Contact material	Ag Sn O2 hv
Energize/release/contact bounce time	10/15/1.5 ms

General data

Mech./ elect. life	20.000.000 switching cycles/load dependent
Test isolation voltage	4 kV; safe separation (EN 60947-1)
Temperature range	-20...+55 °C
Mounting method	DIN-rail mountable (EN 60715)

Dimension drawing

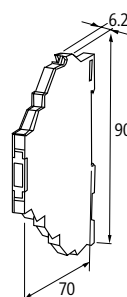
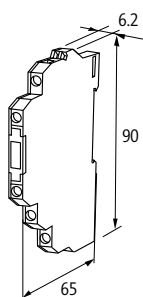

Murrelektronik Online Shop
onlineshop.murrelektronik.com/en

Notes

For inductive loads we recommend EMC suppressors connected parallel to the coil. When the max. switching voltage/current is exceeded the gold plating is destroyed. The relay will then take on the properties of an output type.

RELAYS / SAFETY RELAYS

Terminal relay

MIRO 6.2

Input relay
1 NO contact
Screw terminals



Approvals:   

MIRO 6.2

Input relay
1 NO contact
Spring clamp terminals



Circuit diagram

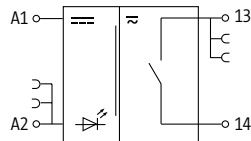

Order Data	Art-No.	Art-No.
24 V DC (19.2...30 V DC - 14 mA)	52004	6652004

Switching capacity (EN 60947-5-1)	
AC-12	6 A (24 V AC; 110 V AC; 230 V AC)
AC-15	3 A (24 V AC; 110 V AC; 230 V AC)
DC-13	1 A (24 V DC); 0.2 A (110 V DC); 0.1 A (230 V DC)

Input	
LED display	LED (yellow)
Output	
Switching voltage	max. 30 V AC/36 V DC
Switching current per output	max. 50 mA
Min. load current	1 mA (12 V DC)
Power rating (voltage dependent)	max. 1500 VA/120 W
Switching frequency	max. 10 Hz
Contact material	Ag Sn O2 hv
Energize/release/contact bounce time	10/15/1.5 ms

General data	
Mech./ elect. life	20.000.000 switching cycles/load dependent
Test isolation voltage	4 kV; safe separation (EN 60947-1)
Temperature range	-20...+55 °C
Mounting method	DIN-rail mountable (EN 60715)

Dimension drawing

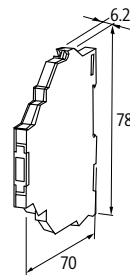
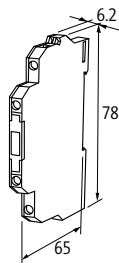

Murrelektronik Online Shop
onlineshop.murrelektronik.com/en

Notes	
	For inductive loads we recommend EMC suppressors connected parallel to the coil. When the max. switching voltage/current is exceeded the gold plating is destroyed. The relay will then take on the properties of an output type.

RELAYS / SAFETY RELAYS

Terminal relay

MIRO 6.2

Input relay
1 NO/NC contact
Screw terminals



MIRO 6.2

Input relay
1 NO/NC contact
Spring clamp terminals



Approvals:

Circuit diagram

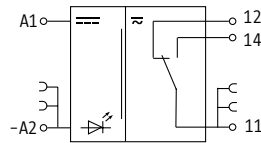

Order Data

	Art-No.	Art-No.
48 V DC (40...53 V DC - 12 mA)	52021	6652021
110 V AC/DC (95...121VAC/DC - 4 mA)	52031	6652031
230 V AC/DC (195...253 V AC/DC - 3 mA)	52041	6652041

Switching capacity (EN 60947-5-1)

AC-12	6 A (24 V AC; 110 V AC; 230 V AC)
AC-15	3 A (24 V AC; 110 V AC; 230 V AC)
DC-13	1 A (24 V DC); 0.2 A (110 V DC); 0.1 A (230 V DC)

Input

LED display LED (yellow)

Output

Switching voltage	max. 30 V AC/36 V DC
Switching current per output	max. 50 mA
Min. load current	1 mA (12 V DC)
Power rating (voltage dependent)	max. 1500 VA/120 W
Switching frequency	max. 10 Hz
Contact material	Ag Sn O2 hv
Energize/release/contact bounce time	10/15/1.5 ms

General data

Mech./ elect. life	20.000.000 switching cycles/load dependent
Test isolation voltage	4 kV; safe separation (EN 60947-1)
Temperature range	-20...+55 °C
Mounting method	DIN-rail mountable (EN 60715)

Dimension drawing

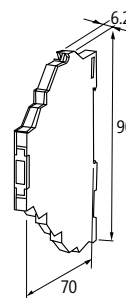
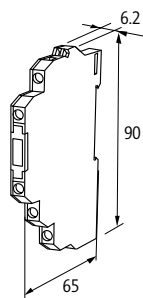

Murrelektronik Online Shop
onlineshop.murrelektronik.com/en

Notes

For inductive loads we recommend EMC suppressors connected parallel to the coil. When the max. switching voltage/current is exceeded the gold plating is destroyed. The relay will then take on the properties of an output type.

RELAYS / SAFETY RELAYS

Terminal relay
– with bridge system

MIRO 12.4
Output relay
2 NO/NC contacts
Screw terminals



MIRO 12.4
Output relay
2 NO/NC contacts
Spring clamp terminals



MIRO 12.4
Input relay
2 NO/NC contacts
Screw terminals



MIRO 12.4
Input relay
2 NO/NC contacts
Spring clamp terminals



Approvals:

Circuit diagram

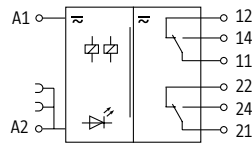

Order Data	Art-No.	Art-No.	Art-No.	Art-No.
24 V DC (19.2...30 V DC - 18 mA)	cCSAus, CCC 52102	cCSAus, CCC 6652102	CCC 52110	CCC 6652110
24 V AC/DC (19.2...30 V AC/DC - 20 mA)	CCC 52103	CCC 6652103	CCC 52111	CCC 6652111
48 V DC (40...53 V DC - 14 mA)	52120	6652120		
110 V AC/DC (95...121 V AC/DC - 7 mA)	52130	6652130	52136	6652136
230 V AC/DC (195...253 V AC/DC - 5 mA)	CCC 52140	CCC 6652140	CCC 52146	CCC 6652146

Switching capacity (EN 60947-5-1)

AC-12	6 A (24 V AC; 110 V AC; 230 V AC)
AC-15	3 A (24 V AC; 110 V AC; 230 V AC)
DC-13	1 A (24 V DC); 0.2 A (110 V DC); 0.1 A (230 V DC)

Input

LED display LED (green)

Output

Switching voltage	max. 250 V AC/DC	max. 30 V AC/36 V DC
Switching current per output	max. 6 A	max. 50 mA
Min. load current	10 mA (12 V DC)	1 mA (12 V DC)
Power rating (voltage dependent)	max. 1500 VA/120 W	
Switching frequency	max. 10 Hz	
Contact material	Ag Sn O2	Ag Sn O2 hv
Energize/release/contact bounce time	10/15/1.5 ms	

General data

Mech./ elect. life	20.000.000 switching cycles/load dependent
Test isolation voltage	4 kV; safe separation (EN 60947-1)
Temperature range	-20...+55 °C
Mounting method	DIN-rail mountable (EN 60715)

Dimension drawing

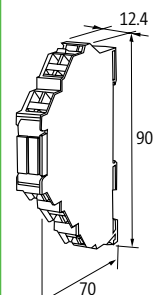
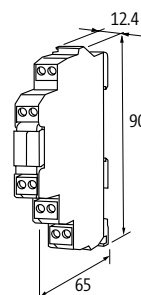
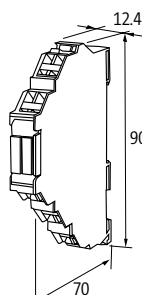
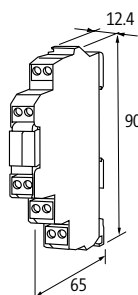

Murrelektronik Online Shop
onlineshop.murrelektronik.com/en

Notes

For inductive loads we recommend EMC suppressors connected parallel to the coil

RELAYS / SAFETY RELAYS

Terminal relay

– with bridge system

MIRO 12.4

Output relay
2 NO contact
Screw terminals



MIRO 12.4

Output relay
2 NO contact
Spring clamp terminals



MIRO 12.4

Output relay
2 NO contact
Screw terminals



MIRO 12.4

Output relay
2 NO contact
Spring clamp terminals



Approvals:

Circuit diagram

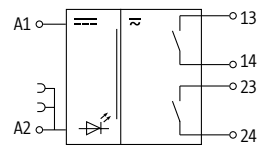
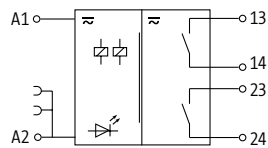

Order Data

24 V AC/DC (19.2...30 V AC/DC - 17 mA)

Art-No.
52104

Art-No.
6652104

Art-No.
52106

Art-No.
6652106

Switching capacity (EN 60947-5-1)

AC-12	6 A (24 V AC; 110 V AC; 230 V AC)
AC-15	3 A (24 V AC; 110 V AC; 230 V AC)
DC-13	1 A (24 V DC); 0.2 A (110 V DC); 0.1 A (230 V DC)

Input

LED display LED (green)

Output

Switching voltage	max. 250 V AC/DC
Switching current per output	max. 6 A
Min. load current	10 mA (12 V DC)
Power rating (voltage dependent)	max. 1500 VA/120 W
Switching frequency	max. 10 Hz
Contact material	Ag Sn O2
Energize/release/contact bounce time	10/15/1.5 ms

General data

Mech./ elect. life	20.000.000 switching cycles/load dependent
Test isolation voltage	4 kV; safe separation (EN 60947-1)
Temperature range	-20...+55 °C
Mounting method	DIN-rail mountable (EN 60715)

Dimension drawing

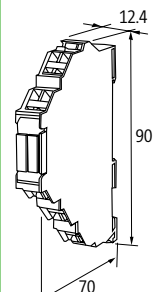
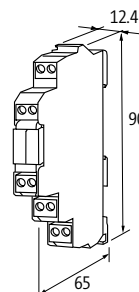
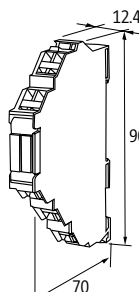
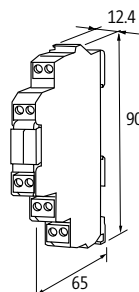

Murrelektronik Online Shop
onlineshop.murrelektronik.com/en

Notes

For inductive loads we recommend EMC suppressors connected parallel to the coil

RELAYS / SAFETY RELAYS

Terminal relay

MIRO 12.4 Multi voltage

Output relay
1 NO/NC contact
Screw terminals



Approvals: 

Circuit diagram

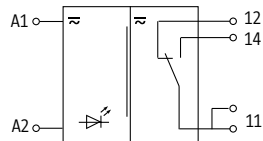

Order Data	Art-No.
24 V AC/DC/6...27 mA	52160
48 V DC/6...27 mA	52160
110 V AC/DC/6...27 mA	52160
230 V AC/DC/6...27 mA	52160

Switching capacity (EN 60947-5-1)

AC-12	6 A (24 V AC; 110 V AC; 230 V AC)
AC-15	3 A (24 V AC; 110 V AC; 230 V AC)
DC-13	1 A (24 V DC); 0.2 A (110 V DC); 0.1 A (230 V DC)

Input	
LED display	LED (green)
Output	
Switching voltage	max. 250 V AC/DC
Switching current per output	max. 6 A
Min. load current	10 mA (12 V DC)
Power rating (voltage dependent)	max. 1500 VA/120 W
Switching frequency	max. 10 Hz
Contact material	Ag Sn O ₂
Energize/release/contact bounce time	10/15/1.5 ms

General data	
Mech./ elect. life	20.000.000 switching cycles/load dependent
Test isolation voltage	4 kV; safe separation (EN 60947-1)
Temperature range	-20...+55 °C
Mounting method	DIN-rail mountable (EN 60715)

Dimension drawing

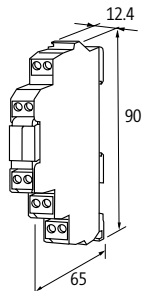

Murrelektronik Online Shop
onlineshop.murrelektronik.com/en

Notes	
	For inductive loads we recommend EMC suppressors connected parallel to the coil

RELAYS / SAFETY RELAYS

Relays

– Screw terminals

RMM

Output relay
1 relay; 1 NO contact
with minus plug link



RMM

Output relay
1 relay; 1 NC contact
with minus plug link

Circuit diagram

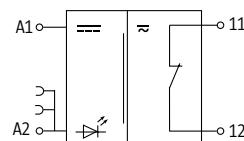
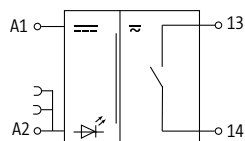

Order Data

24 V AC/DC ($\pm 10\%$ - 15 mA)

48 V AC/DC ($\pm 10\%$ - 10 mA)

Art-No.

51851

51850

Art-No.

51808

Switching capacity (EN 60947-5-1)

AC-1 5 A (24 V AC; 110 V AC; 230 V AC)

AC-15 3 A (24 V AC; 110 V AC; 230 V AC)

DC-13 1.5 A (24 V DC); 0.3 A (110 V DC); 0.15 A (230 V DC)

1.3 A (24 V DC); 0.3 A (110 V DC); 0.15 A (230 V DC)

Input

Plug link (supplied) Art-Nr. 90960

LED display LED (red)

Output

Switching voltage max. 250 V AC/300 V DC

Switching current per output max. 5 A

Min. load current 100 mA

Power rating (voltage dependent) max. 1250 VA/240 W

Switching frequency max. 10 Hz

Contact material Ag Ni 0.15 hv

Energize/release/contact bounce time 10/15/1.5 ms

General data

Mech./ elect. life 20.000.000 switching cycles/load dependent

Test isolation voltage 4 kV

Temperature range -20...+50 °C

Mounting method DIN-rail mountable TH35 or G32 (EN 60715)

Dimension drawing

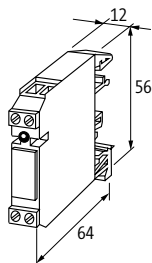

Murrelektronik Online Shop
onlineshop.murrelektronik.com/en

Notes

RELAYS / SAFETY RELAYS

Relays

– Screw terminals

RMM

Output relay
1 relay; 1 NO contact



RMM

Output relay
1 relay; 1 NC contact

Circuit diagram

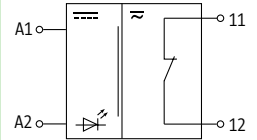
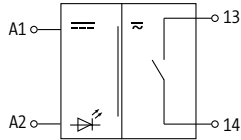

Order Data	Art-No.	Art-No.	Art-No.	Art-No.
24 V AC/DC ($\pm 10\%$ - 15 mA)	51551			51508
48 V AC/DC ($\pm 10\%$ - 10 mA)	51550			
24 V AC/DC/5 mA		512764		
110 V AC (+10 -15 % - 3.5 mA)			51552	
230 V AC (+10 -15 % - 3.5 mA)			51515	51562

Switching capacity (EN 60947-5-1)

AC-12	–	6 A (24 V AC; 110 V AC; 230 V AC)	5 A (24 V AC; 110 V AC; 230 V AC)	
AC-1	5 A (24 V AC; 110 V AC; 230 V AC)	–		
AC-15	3 A (24 V AC; 110 V AC; 230 V AC)	4 A (24 V AC; 110 V AC; 230 V AC)	3 A (24 V AC; 110 V AC; 230 V AC)	
DC-13	1.5 A (24 V DC); 0.3 A (110 V DC); 0.15 A (230 V DC)	1 A (24 V DC); 0.2 A (110 V DC); 0.1 A (230 V DC)	2 A (24 V DC); 0.25 A (110 V DC); 0.1 A (230 V DC)	1.3 A (24 V DC); 0.3 A (110 V DC); 0.15 A (230 V DC)

Input

LED display	LED (red)	LED (green)	LED (red)
-------------	-----------	-------------	-----------

Output

Switching voltage	max. 250 V AC/300 V DC		
Switching current per output	max. 5 A		
Min. load current	100 mA		
Power rating (voltage dependent)	max. 1250 VA/240 W		
Switching frequency	max. 10 Hz		
Contact material	Ag Ni 0.15 hv; Ag hv		
Energize/release/contact bounce time	10/15/1.5 ms		

General data

Mech./ elect. life	20.000.000 switching cycles/load dependent
Test isolation voltage	4 kV
Temperature range	-20...+50 °C
Mounting method	DIN-rail mountable TH35 or G32 (EN 60715)

Dimension drawing

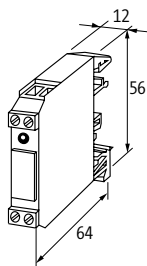

Murrelektronik Online Shop
onlineshop.murrelektronik.com/en

Notes

RELAYS / SAFETY RELAYS

Relays

– Screw terminals

RMME

Input relay
1 relay; 1 NO contact
with minus plug link



RMME

Input relay
1 relay; 1 NO contact



RMME

Input relay
1 relay; 1 NC contact

Circuit diagram

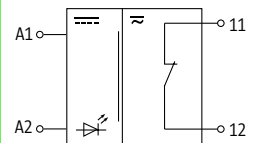
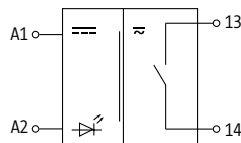
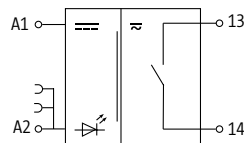

Order Data

	Art-No.	Art-No.	Art-No.	Art-No.
24 V AC/DC ($\pm 10\%$ - 6 mA)	51860	51560		
48 V AC/DC ($\pm 10\%$ - 10 mA)		51553		
110 V AC (+10 -15% - 7 mA)		51526		
230 V AC (+10 -15% - 6 mA)			51517	
24 V AC/DC ($\pm 10\%$ - 15 mA)				51571

Switching capacity (EN 60947-5-1)

AC-15	1 A (24 V AC); 0.5 A (125 V AC)	0.25 A (50 V AC)	3 A (24 V AC; 110 V AC; 230 V AC)
DC-13	1 A (24 V DC); 0.5 A (125 V DC)	–	1.5 A (24 V DC); 0.3 A (110 V DC); 0.15 A (230 V DC)
AC-1	–		5 A (24 V AC; 110 V AC; 230 V AC)
AC-12	–	0.5 A (50 V AC)	–

Input

Plug link (supplied)	Art.-Nr. 90960	–	
LED display	LED (yellow)		

Output

Switching voltage	max. 125 V AC/DC
Switching current per output	max. 1 A
Min. load current	1 mA
Power rating (voltage dependent)	max. 60 VA/30 W
Switching frequency	max. 15 Hz
Contact material	Pd Ni-Au Rh
Energize/release/contact bounce time	10/10/1 ms

General data

Mech./ elect. life	100.000.000 switching cycles/load dependent
Test isolation voltage	1.5 kV
Temperature range	-20...+60 °C
Mounting method	DIN-rail mountable TH35 or G32 (EN 60715)

Dimension drawing

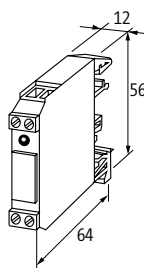
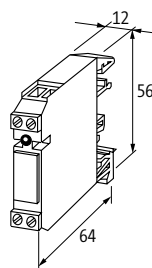

Murrelektronik Online Shop
onlineshop.murrelektronik.com/en

Notes

RELAYS / SAFETY RELAYS

Relays

– with minus plug link

– Screw terminals

RMMD

Output relay
1 relay; 1 NO contact
Safe separation (IEC 61140/
EN 61140)



RMMD

Output relay
1 relay; 1 NO contact

RMMD

Output relay
1 relay; 1 NO/NC contact
Safe separation (IEC 61140/
EN 61140)

RMMD

Output relay
1 relay; 1 NO/NC contact
with low connection current

Circuit diagram

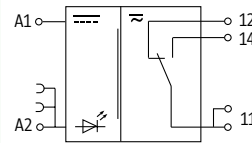
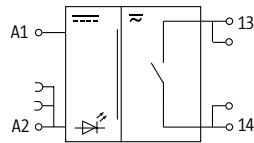

Order Data	Art-No.	Art-No.	Art-No.	Art-No.
24 V DC ($\pm 10\%$ - 17 mA)	51100		51120	
230 V AC (+10 -15 % - 5 mA)		51108		
24 V AC/DC ($\pm 10\%$ - 10 mA)				51125

Switching capacity (EN 60947-5-1)

AC-1	8 A (24 V AC; 110 V AC; 230 V AC)	6 A (24 V AC; 110 V AC; 230 V AC)	8 A (24 V AC; 110 V AC; 230 V AC)
AC-15	3 A (24 V AC; 110 V AC; 230 V AC)	4 A (24 V AC; 110 V AC; 230 V AC)	3 A (24 V AC; 110 V AC; 230 V AC)
DC-13	2.5 A (24 V DC); 0.4 A (110 V DC); 0.3 A (230 V DC)	2 A (24 V DC); 0.25 A (110 V DC); 0.1 A (230 V DC)	2.5 A (24 V DC); 0.4 A (110 V DC); 0.3 A (230 V DC)

Input

Plug link (supplied)	Art-Nr. 90960	–	Art-Nr. 90960
LED display	LED (red)		

Output

Switching voltage	max. 250 V AC/DC		
Switching current per output	max. 8 A	max. 6 A	max. 8 A
Min. load current	100 mA		
Power rating (voltage dependent)	max. 2000 VA/240 W		
Switching frequency	max. 10 Hz		
Contact material	Ag Ni		
Energize/release/contact bounce time	10/15/2 ms		

General data

Mech./ elect. life	20.000.000 switching cycles/load dependent		
Test isolation voltage	5 kV	4 kV	5 kV
Temperature range	-20...+50 °C		
Mounting method	DIN-rail mountable TH35 or G32 (EN 60715)		

Dimension drawing

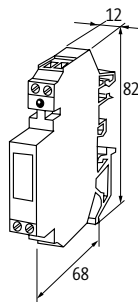

Murrelektronik Online Shop
onlineshop.murrelektronik.com/en

Notes

RELAYS / SAFETY RELAYS

Relays

- with minus plug link
- Hand-O-Auto
- Screw terminals

RMMDH
Output relay
1 relay; 1 NO/NC contact



RMMDH
Output relay
1 relay; 1 NO contact
CTL alarm output

RMMDH
Output relay
1 relay; 2 NO contacts
Toggle switch for bridging the NO contact

Circuit diagram

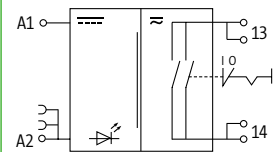
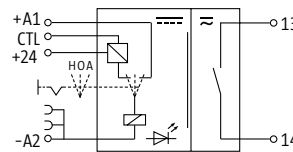
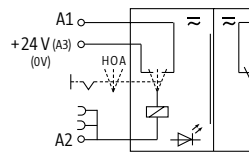

Order Data

	Art-No.	Art-No.	Art-No.
24 V AC/DC (±10 % - 16 mA)	51152		
24 V DC (±10 % - 16 mA)		51153	
24 V DC (±10 % - 10 mA)			51101

Switching capacity (EN 60947-5-1)

AC-1	8 A (24 V AC; 110 V AC; 230 V AC)	3 A (24 V AC; 110 V AC; 230 V AC)
AC-15	3 A (24 V AC; 110 V AC; 230 V AC)	
DC-13	1.5 A (24 V DC); 0.3 A (110 V DC); 0.15 A (230 V DC)	

Input

Plug link (supplied)	Art-Nr. 90960
LED display	LED (red)

Output

Switching voltage	max. 250 V AC/DC	max. 250 V AC/30 V DC
Switching current per output	max. 8 A	max. 8 A; CTL: 10 mA
Min. load current	100 mA	
Power rating (voltage dependent)	max. 2000 VA/240 W	max. 750 VA/90 W
Switching frequency	max. 15 Hz	
Contact material	Ag Ni	Ag Cd 0
Energize/release/contact bounce time	10/10/2 ms	

General data

Mech./ elect. life	30.000.000 switching cycles/load dependent	
Test isolation voltage	3 kV	4 kV
Temperature range	-20...+50 °C	
Mounting method	DIN-rail mountable TH35 or G32 (EN 60715)	

Dimension drawing

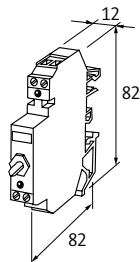

Murrelektronik Online Shop
onlineshop.murrelektronik.com/en

Notes

RELAYS / SAFETY RELAYS

Relays

- with minus plug link
- with bridge system
- Screw terminals

RMMDE

Input relay
1 relay; 1 NO contact/1 NC contact



RMMDE

Input relay
1 relay; 1 NO/NC contact

RMMDE

Input relay
1 relay; 2 NO contacts

Circuit diagram

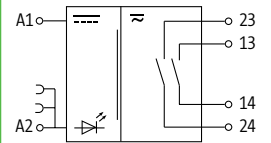
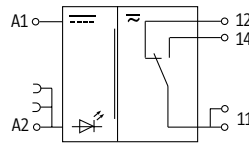
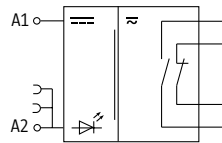

Order Data	Art-No.	Art-No.	Art-No.	Art-No.
24 V DC ($\pm 10\%$ - 20 mA)	516014			
24 V DC ($\pm 10\%$ - 15 mA)		51130		51140
230 V AC (+10 -15 % - 5 mA)			51138	
Switching capacity (EN 60947-5-1)				
AC-1	3 A (24 V AC); 2 A (230 V AC)	5 A (24 V AC; 110 V AC; 230 V AC)		2 A (24 V AC; 110 V AC; 230 V AC)
AC-15	1 A (24 V AC); 0.1 A (230 V AC)	3 A (24 V AC; 110 V AC; 230 V AC)	4 A (24 V AC; 110 V AC; 230 V AC)	1 A (24 V AC); 0.1 A (230 V AC)
DC-13	0.8 A (24 V DC); 0.01 A (230 V DC)	1.3 A (24 V DC); 0.25 A (110 V DC); 0.10 A (230 V DC)		2 A (24 V DC); 0.25 A (110 V DC); 0.1 A (230 V DC)
0.8 A (24 V DC); 0.01 A (110 V DC); 0.01 A (230 V DC)				
Input				
Plug link (supplied)	Art-Nr. 90960		-	Art-Nr. 90960
LED display	LED (red)	LED (yellow)		
Output				
Switching voltage	max. 250 V AC/DC			
Switching current per output	max. 3 A	max. 20 mA	max. 5 A	max. 2 A
Min. load current	1 mA			5 mA
Power rating (voltage dependent)	max. 500 VA/180 W	max. 1500 VA/180 W		max. 250 VA/150 W
Switching frequency	max. 10 Hz	max. 15 Hz		
Contact material	Ag Ni 0.15 hv	Ag Ni 0.15 hv; Ag hv		Ag Au
Energize/release/contact bounce time	6/3/2 ms	10/10/1 ms		
General data				
Mech./ elect. life	20.000.000 switching cycles/load dependent	100.000.000 switching cycles/load dependent		20.000.000 switching cycles/load dependent
Test isolation voltage	2.5 kV	4 kV		1.5 kV
Temperature range	-20...+60 °C	-20...+50 °C		
Mounting method	DIN-rail mountable TH35 or G32 (EN 60715)			
Dimension drawing				
Notes				

Relays

– Screw terminals

RM

Output relay
1 relay; 2 NO/NC contacts



RM

Output relay
1 relay; 4 NO/NC contacts

RM

Output relay
2 relays; each 1 NO/NC contact

RM

Output relay
2 relays; each 2 NO/NC contacts

Circuit diagram

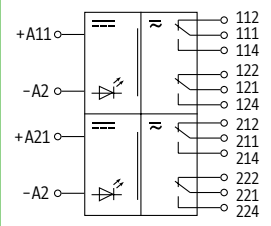
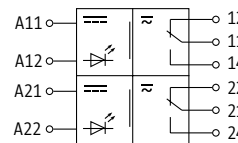
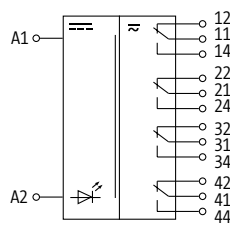
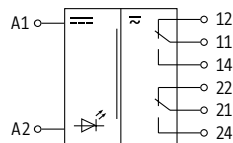

Order Data	Art-No.	Art-No.	Art-No.	Art-No.
24 V AC/DC (±10 % - 20 mA)	51540	51410		
230 V AC (+10 -15 % - 10 mA)		51413	51412	
24 V AC/DC (±10 % - 10 mA)			51485	
24 V AC/DC (±10 % - 14 mA)				51465
Switching capacity (EN 60947-5-1)				
AC-1	8 A (24 V AC; 110 V AC; 230 V AC)	–	8 A (24 V AC; 110 V AC; 230 V AC)	
AC-12	–	2 A (24 V AC); 0.5 A (230 V AC)	–	
AC-15	3 A (24 V AC; 110 V AC; 230 V AC)	1 A (24 V AC); 0.1 A (230 V AC)	3 A (24 V AC; 110 V AC; 230 V AC)	
DC-13	2 A (24 V DC); 0.3 A (110 V DC); 0.2 A (230 V DC)	0.8 A (24 V DC); 0.01 A (230 V DC)	1.5 A (24 V DC); 0.3 A (110 V DC); 0.15 A (230 V DC)	2 A (24 V DC); 0.3 A (110 V DC); 0.2 A (230 V DC)
Input				
LED display	LED (red)			
Output				
Switching voltage	max. 250 V AC/DC			
Switching current per output	max. 8 A	max. 2 A	max. 8 A	
Min. load current	100 mA	0.1 mA	100 mA	
Power rating (voltage dependent)	max. 1250 VA/240 W	max. 125 VA/60 W	max. 1250 VA/240 W	
Switching frequency	max. 0.1 Hz (with load)			
Contact material	Ag Ni 0.15 hv	Ag Au	Ag Sn O2	Ag Ni 0.15 hv
Energize/release/contact bounce time	10/10/2 ms	10/20/2 ms	10/10/2 ms	
General data				
Mech./ elect. life	50.000.000 switching cycles/load dependent		20.000.000 switching cycles/load dependent	
Test isolation voltage	4 kV	1.5 kV	4 kV	
Temperature range	-20...+50 °C			
Mounting method	DIN-rail mountable TH35 or G32 (EN 60715)			
Dimension drawing				
Notes				

Murrelektronik Online Shop
onlineshop.murrelektronik.com/en

RELAYS / SAFETY RELAYS

Relays

- Screw terminals
- with force guided contacts

RM

Output relay
1 relay; 2 NO contacts/2 NC contacts



RM

Output relay
1 relay; 3 NO contacts/1 NC contact

MKS

Output relay
1 relay; 1 NO contact/1 NC contact



Circuit diagram

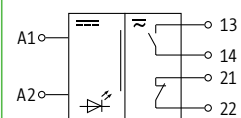
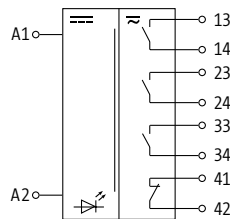
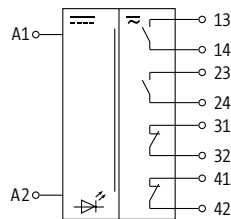

Order Data

	Art-No.	Art-No.	Art-No.
24 V DC (±10% - 17 mA)	51300	51301	
24 V DC (±10% - 38 mA)			51302

Switching capacity (EN 60947-5-1)

	RM (51300)	RM (51301)	MKS (51302)
AC-1	5 A (24 V AC; 110 V AC; 230 V AC)		6 A (24 V AC; 110 V AC; 230 V AC)
DC-13	2 A (24 V DC); 0.4 A (110 V DC); 0.2 A (230 V DC)		3 A (24 V DC); 0.22 A (110 V DC); 0.1 A (230 V DC)
AC-15	4 A (24 V AC); 3 A (110 V AC); 2 A (230 V AC)		3 A (24 V AC; 110 V AC; 230 V AC)

Input

LED display	LED (red)	LED (green)
-------------	-----------	-------------

Output

Switching voltage	max. 250 V AC/DC	
Switching current per output	max. 5 A	max. 6 A
Min. load current	300 mA	10 mA
Power rating (voltage dependent)	max. 1000 VA/50 W	
Switching frequency	max. 0.1 Hz (with load)	max. 1 Hz
Contact material	Ag Ni 10 hv	Ag hv; Ag Sn O2
Energize/release/contact bounce time	15/15/2 ms	15/15/1.5 ms

General data

Mech./ elect. life	1.000.000 switching cycles/load dependent	10.000.000 switching cycles/load dependent
Test isolation voltage	2.5 kV	4 kV
Temperature range	-20...+50 °C	
Mounting method	DIN-rail mountable TH35 or G32 (EN 60715)	

Dimension drawing

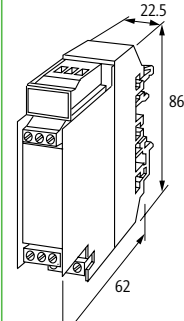
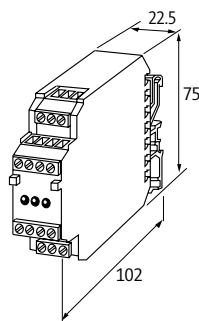

Murrelektronik Online Shop
onlineshop.murrelektronik.com/en

Notes

RELAIS / SICHERHEITSRELAIS

Relaissockel

– für Steckrelais MRS

– Schraubklemmen

MRB

1 oder 2 Wechsler
Schraubklemmen



Schaltbild

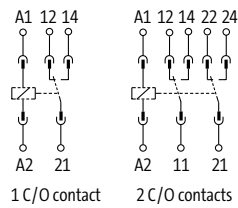

Bestelldaten

max. 250 V AC

Art-Nr.

51353

Zubehör

Entstörmodul 24 V DC

Art-Nr.

61340

Entstörmodul 110/230 V AC

61342

Steckrelais, 1 Wechsler, 24 V DC

61352

Steckrelais, 1 Wechsler, 24 V AC

61354

Steckrelais, 1 Wechsler, 110 V AC

61356

Steckrelais, 1 Wechsler, 230 V AC

61358

Steckrelais, 2 Wechsler, 24 V DC

61353

Steckrelais, 2 Wechsler, 24 V AC

61355

Steckrelais, 2 Wechsler, 110 V AC

61357

Steckrelais, 2 Wechsler, 230 V AC

61359

Technische Daten

Zusatzbeschaltung

aufsteckbares Entstörmodul MRE

Schaltspannung

max. 250 V AC

Schaltstrom

max. 16 A

Allgemeine Daten

Normen

berührungsgeschützt (VBG 4) und (VDE 0106) Teil 100 und 101

Prüf-Isolationsspannung

5 kV

Anschlussart

Schraubklemmen: max. 4 mm²

Befestigungsart

schnappbar auf Tragschiene (EN 60715)

Maßskizze

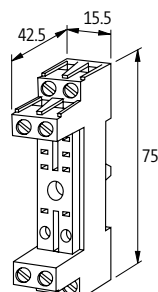

Murrelektronik Online Shop
onlineshop.murrelektronik.com

Hinweis

RELAYS / SAFETY RELAYS

Safety relay

- Protection-door and emergency-stop control

Approvals:  Listed

MIRO SAFE+ Switch H 48-230 with/without start button monitoring



Circuit diagram

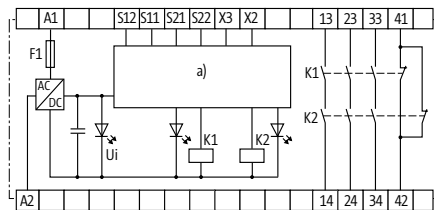

Order Data	Art-No.
3 safety contacts	3000-33113-1020012
Switching capacity (EN 60947-5-1)	
Safety contacts (STOP 0)	max. 250 V AC/6 A; min. 10 V AC/10 mA (ohm./ind.), at suitable suppression
AC-15	6 A (230 V AC) STOP0
DC-13	6 A (24 V DC) STOP0
Technical Data	
Achievable safety category to:	4/PL e (EN ISO 13849-1)
Contact material	AgSnO, self cleaning, positively driven
Input	
Input voltage	48...240 V AC
Input current	max. 2.8 VA
Output	
Switching voltage	max. 250 V AC/DC
Switching current per output	max. 6 A
Number of auxiliary contacts	1 - (41-42)
Number of alarm outputs	0
Number of safety contacts	3 - (13-14); (23-24); (33-34)
General data	
Mech./ elect. life	10.000.000 switching cycles/load dependent
Temperature range	-25...+45 °C (storage temperature -40...+85 °C)
Connection	Spring clamp plug-in terminals
Mounting method	DIN-rail mountable (EN 60715)
Dimension drawing	

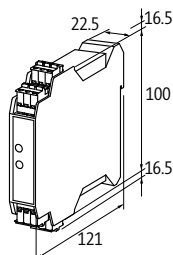

Murrelektronik Online Shop
onlineshop.murrelektronik.com/en

Notes

RELAYS / SAFETY RELAYS

Safety relay

- Protection-door and emergency-stop control
- Light curtain control
- Safety magnetic switch control

Approvals:  **UL** US Listed

MIRO SAFE+ Switch H L 24

with/without start button monitoring



Circuit diagram

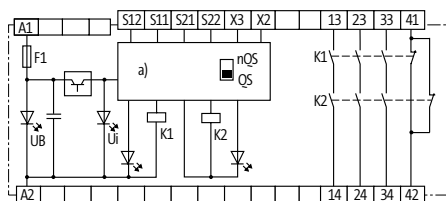

Order Data

3 safety contacts

Art-No.

3000-33113-3020012

Switching capacity (EN 60947-5-1)

Safety contacts (STOP 0)

max. 250 V AC/8 A; min. 10 V AC/10 mA (ohm./ind.), at suitable suppression

AC-15

6 A (230 V AC) STOP 0

DC-13

6 A (24 V DC) STOP 0

Technical Data

Achievable safety category to:

4/PL e (EN ISO 13849-1)

Contact material

AgSnO, self cleaning, positively driven

Input

Input voltage

24 V DC (-15/+20 %), 24 V AC (-15/+10 %)

Input current

max. 4.9 VA/2.0 W

Output

Switching voltage

max. 250 V AC/DC

Switching current per output

max. 8 A

Total current

24 A (45 °C); 18 A (55 °C); 12 A (60 °C)

Number of auxiliary contacts

1 - (41-42)

Number of alarm outputs

0

Number of safety contacts

3 - (13-14); (23-24); (33-34)

General data

Mech./ elect. life

10.000.000 switching cycles/load dependent

Temperature range

-25...+60 °C (storage temperature -40...+85 °C)

Mounting method

DIN-rail mountable (EN 60715)

Dimension drawing

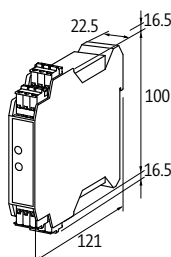

Murrelektronik Online Shop
onlineshop.murrelektronik.com/en

Notes

RELAYS / SAFETY RELAYS

Safety relay

- Protection-door and emergency-stop control
- Light curtain control
- Safety magnetic switch control

Approvals:  Listed

MIRO SAFE+ Switch ECOA 24

without start button monitoring



Circuit diagram

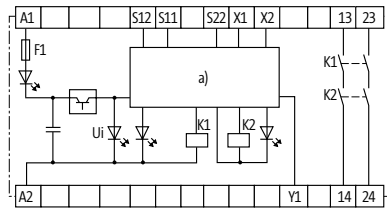

Order Data	Art-No.
2 safety contacts	3000-33113-3020005
Switching capacity (EN 60947-5-1)	
Safety contacts (STOP 0)	max. 250 V AC/6 A; min. 5 V AC/1 mA (ohm./ind.), at suitable suppression
AC-15	2 A (230 V AC) STOP 0
DC-13	1 A (24 V DC) STOP 0
Alarm outputs	100 mA (24 V DC)
Technical Data	
Achievable safety category to:	4/PL e (EN ISO 13849-1)
Contact material	AgSnO, self cleaning, positively driven
Input	
Input voltage	24 V DC (-15/+20 %), 24 V AC (-15/+10 %)
Input current	max. 5.2 VA/2.0 W
Output	
Switching voltage	max. 250 V AC/DC
Switching current per output	max. 4 A
Number of auxiliary contacts	0
Number of alarm outputs	1 - (Y1)
Number of safety contacts	2 - (13-14; 23-24)
General data	
Mech./ elect. life	10.000.000 switching cycles/load dependent
Temperature range	-25...+60 °C (storage temperature -40...+85 °C)
Connection	Screw terminals
Mounting method	DIN-rail mountable (EN 60715)
Dimension drawing	

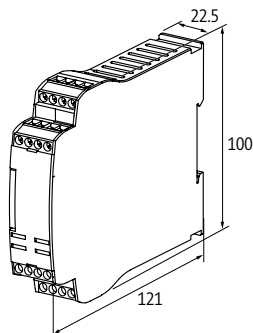

Murrelektronik Online Shop
onlineshop.murrelektronik.com/en

Notes

RELAYS / SAFETY RELAYS

Safety relay

- Protection-door and emergency-stop control
- Light curtain control
- Safety magnetic switch control

Approvals:  UL Listed

MIRO SAFE+ Switch BA L 24

without start button monitoring



MIRO SAFE+ Switch BCS L 24

with start button monitoring



Circuit diagram

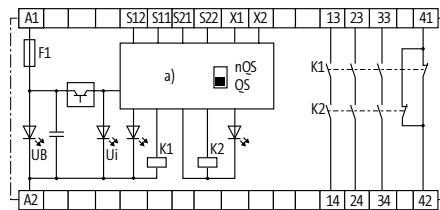

Order Data

3 safety contacts

Art-No.

3000-33113-3020025

Art-No.

3000-33113-3020020

Switching capacity (EN 60947-5-1)

Safety contacts (STOP 0)

max. 250 V AC/8 A; min. 10 V AC/10 mA (ohm./ind.), at suitable suppression

AC-15

6 A (230 V AC) STOP 0

DC-13

6 A (24 V DC) STOP 0

Technical Data

Achievable safety category to:

4/PL e (EN ISO 13849-1)

Contact material

AgSnO, self cleaning, positively driven

Input

Input voltage

24 V DC (-15/+20 %), 24 V AC (-15/+10 %)

Input current

max. 4.9 VA/2.0 W

max. 4.4 VA/1.8 W

Output

Switching voltage

max. 250 V AC/DC

Switching current per output

max. 8 A

Total current

24 A (45 °C); 18 A (55 °C); 12 A (60 °C)

Number of auxiliary contacts

1 - (41-42)

Number of alarm outputs

0

Number of safety contacts

3 - (13-14); (23-24); (33-34)

General data

Mech./ elect. life

10.000.000 switching cycles/load dependent

Temperature range

-25...+60 °C (storage temperature -40...+85 °C)

Connection

Screw terminals

Mounting method

DIN-rail mountable (EN 60715)

Dimension drawing

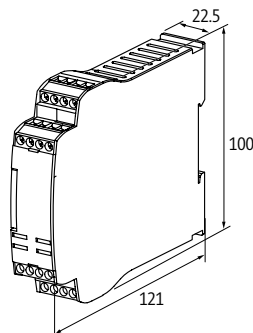

Murrelektronik Online Shop

onlineshop.murrelektronik.com/en

Notes

RELAYS / SAFETY RELAYS

Safety relay

- Protection-door and emergency-stop control
- Light curtain control
- Safety magnetic switch control

Approvals:  Listed

MIRO SAFE+ T 1 24

with/without start button monitoring



MIRO SAFE+ T 2 24

with/without start button monitoring



Circuit diagram

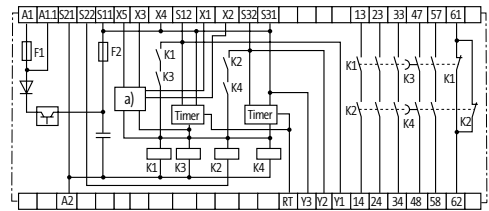
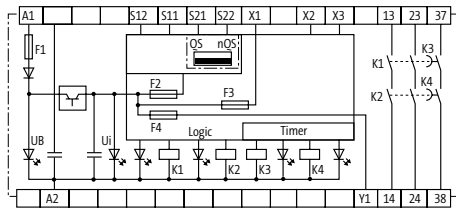

Order Data	Art-No.	Art-No.
3 safety contacts	3000-33113-3020065	
5 safety contacts		3000-33113-3020060

Switching capacity (EN 60947-5-1)

Safety contacts (STOP 0)	max. 250 V AC/8 A; min. 5 V AC/5 mA (ohm./ind.), at suitable suppression	max. 250 V AC/8 A; min. 10 V AC/10 mA (ohm./ind.), at suitable suppression
Safety contacts (STOP 1)	max. 250 V AC/6 A; min. 10 V AC/10 mA (ohm./ind.), at suitable suppression	

AC-15	6 A (230 V AC) STOP 0; 3 A (230 V AC) STOP 1	
DC-13	5 A (24 V DC) STOP 0; 2 A (24 V DC) STOP 1	6 A (24 V DC) STOP 0; 2 A (24 V DC) STOP 1

Technical Data

Achievable safety category to:	4/PL e (STOP 0); 3/PL d (STOP 1) - (EN ISO 13849-1)	
Contact material	AgSnO, self cleaning, positively driven	

Input		
Input voltage	24 V DC (-15/+20 %), 24 V AC (-15/+10 %)	
Input current	5.9 VA/2.4 W (with monitoring output)	max. 7.1 VA/3.2 W (with monitoring output)

Output		
Switching voltage	max. 250 V AC/DC	
Switching current per output	max. 8 A (STOP 0); max. 6 A (STOP 1)	max. 6 A

Total current (STOP 0)	-	18 A (45 °C); 15 A (55 °C); 12 A (60 °C)
Number of auxiliary contacts	0	1 - (31-32)

Total current (STOP 1)	-	12 A (45 °C); 10 A (55 °C); 8 A (60 °C)
Number of alarm outputs	1 - (Y1)	3 - (13-14); (23-24); (33-34)

Number of safety contacts	2 - (13-14), (23-24), STOP 0; 1 - (37-38), STOP 1	3 - (13-14), (23-24), (33-34), STOP 0; 2 - (47-48), (57-58), STOP 1
---------------------------	---	---

General data

Mech./ elect. life	10.000.000 switching cycles/load dependent	
Temperature range	-25...+60 °C (storage temperature -40...+85 °C)	

Connection	Spring clamp plug-in terminals	
Mounting method	DIN-rail mountable (EN 60715)	

Dimension drawing

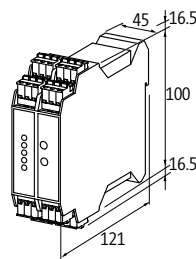
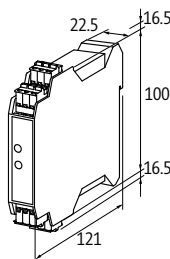

Murrelektronik Online Shop
onlineshop.murrelektronik.com/en

Notes

RELAYS / SAFETY RELAYS

Safety relay

– Two hand control

MIRO SAFE+ HAND 24

without start button monitoring



Approvals:  UL US
Listed

Circuit diagram

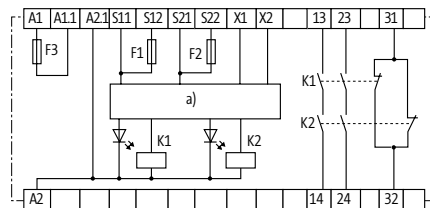

Order Data

2 safety contacts

Art-No.

3000-33113-3020030

Switching capacity (EN 60947-5-1)

Safety contacts (STOP 0)

max. 250 V AC/6 A; min. 10 V AC/10 mA (ohm./ind.), at suitable suppression

AC-15

6 A (230 V AC) STOP 0

DC-13

6 A (24 V DC) STOP 0

Technical Data

Achievable safety category to:

4/PL e (EN ISO 13849-1)

Contact material

AgSnO, self cleaning, positively driven

Input

Input voltage

24 V DC $\pm 10\%$

Input current

max. 1.2 W

Output

Switching voltage

max. 250 V AC/DC

Switching current per output

max. 6 A

Number of auxiliary contacts

1 - (31-32)

Number of alarm outputs

0

Number of safety contacts

2 - (13-14); (23-24)

General data

Mech./ elect. life

10.000.000 switching cycles/load dependent

Temperature range

-25...+60 °C (storage temperature -40...+85 °C)

Connection

Spring clamp plug-in terminals

Mounting method

DIN-rail mountable (EN 60715)

Dimension drawing

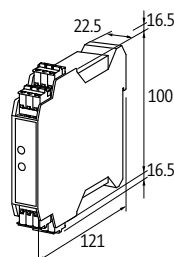

Murrelektronik Online Shop
onlineshop.murrelektronik.com/en

Notes

RELAYS / SAFETY RELAYS

Safety relay

- Protection-door control
- Pressure-sensitive mat. control

Approvals:  Listed

MIRO SAFE+ STEP 24 without start button monitoring



Circuit diagram

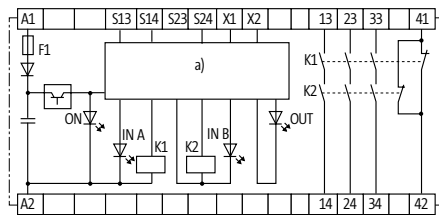

Order Data	Art-No.
3 safety contacts	3000-33113-3020050
Switching capacity (EN 60947-5-1)	
Safety contacts (STOP 0)	max. 250 V AC/8 A; min. 10 V AC/10 mA (ohm./ind.), at suitable suppression
AC-15	6 A (230 V AC) STOP 0
DC-13	6 A (24 V DC) STOP 0
Technical Data	
Achievable safety category to:	4/PL e (EN ISO 13849-1)
Contact material	AgSnO, self cleaning, positively driven
Input	
Input voltage	24 V DC (-15/+20 %), 24 V AC (-15/+10 %)
Input current	max. 3.7 VA/1.6 W (24 V DC)
Output	
Switching voltage	max. 250 V AC/DC
Switching current per output	max. 8 A
Number of auxiliary contacts	1 - (41-42)
Number of alarm outputs	0
Number of safety contacts	3 - (13-14); (23-24); (33-34)
General data	
Mech./ elect. life	10.000.000 switching cycles/load dependent
Temperature range	-25...+60 °C (storage temperature -40...+85 °C)
Connection	Spring clamp plug-in terminals
Mounting method	DIN-rail mountable (EN 60715)
Dimension drawing	

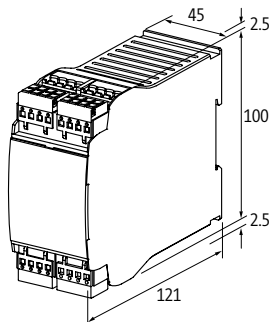

Murrelektronik Online Shop
onlineshop.murrelektronik.com/en

Notes

RELAYS / SAFETY RELAYS

Expansion modules

MIRO SAFE+ E 24

Expansion module



Approvals:  **UL** ^{US}
Listed

Circuit diagram

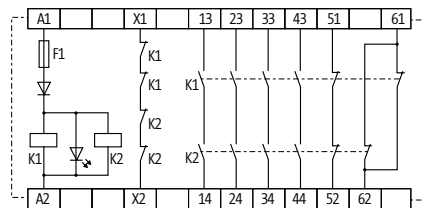

Order Data

4 NO Art-No. 3000-33113-3020075

Switching capacity (EN 60947-5-1)

Safety contacts (STOP 0) max. 250 V AC/6 A; min. 10 V AC/10 mA (ohm./ind.), at suitable suppression

AC-15 6 A (230 V AC)

DC-13 6 A (24 V DC)

Technical Data

Achievable safety category to: 4/PL e (EN ISO 13849-1) depending on basic module

Contact material AgSnO, self cleaning, positively driven

Input

Input voltage 24 V DC (-15/+20 %), 24 V AC (-15/+10 %)

Input current max. 1.0 VA

Output

Switching voltage max. 250 V AC/DC

Switching current per output max. 6 A

Number of auxiliary contacts 2 - (51-52); (61-62)

Number of alarm outputs 0

Number of contacts 4 - (13-14); (23-24); (33-34); (43-44)

General data

Mech./ elect. life 10.000.000 switching cycles/load dependant

Temperature range -25...+45 °C (storage temperature -40...+85 °C)

Connection Spring clamp plug-in terminals

Mounting method DIN-rail mountable (EN 60715)



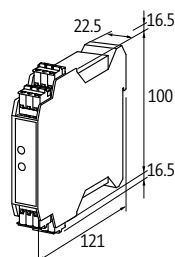





Dimension drawing



Murrelektronik Online Shop
onlineshop.murrelektronik.com/en

Notes

RELAYS / SAFETY RELAYS

Labeling accessories			Art-No.
	ACS label plate KM 5 for self marking (9 × 20 mm) 5 × 10 mm		7000-99001-000000 90931
	ACS label plate KM 6/18 for self marking with ADEMARK markers		7000-99003-000000
	Label plate KWI 5/15 (88 pieces per plate)		90901
Wiring accessories			Art-No.
	Potential plug link max. 48 V/2 A	RMM..., RMMD...	90960
	Potential plug link max. 50 V/2 A	MIRO	90961
	Potential rail blue 10-pole, spacing 6.2 mm	MIRO 6.2 (screw terminals)	90975
	40-pole, spacing 12 mm	RMM..., RMMD...	90970
	Potential rail red 10-pole, spacing 6.2 mm	MIRO 6.2 (screw terminals)	90976
	40-pole, spacing 12 mm	RMM..., RMMD...	90971
	End caps for potential rail blue	MIRO 6.2	90980
	red	RMM..., RMMD...	90982
	Wire chain 16-pole		
	Connection cable left and right approx. 50 cm; bk; 1 mm ²	MIRO (spring clamp terminals)	90977

RELAYS / SAFETY RELAYS

Wiring accessories			Art-No.
	Double spring clamp terminal		
	pluggable	MIRO SAFE	3000-33010-0000000

OPTOCOUPLERS / SEMICONDUCTORS SWITCHING WITHOUT WEAR

- Shortest possible switching times
- High switching frequencies
- Resistant to EMC interference

MILLIONS OF SWITCHING CYCLES – EVEN WITH HIGH FREQUENCIES

Optocouplers and semiconductors are used to combine different signal levels or to isolate one signal from another. They are similar to a relay interface because they provide an optoelectronic signal transfer between input and output.

Optocouplers and semiconductors have a long life span because they don't have any mechanical components that could wear out. They are suitable for applications with high switching frequencies, even over a long time.

Some benefits of optocouplers and semiconductors:

- Silent operation
- No contact bounce
- Galvanic separation between input and output
- High resistance to shock and vibration
- High switching currents
- Low input power

Optocouplers / Semiconductors



Optocouplers

- DC applications

Page 1.11.1



Semiconductors

- AC applications

Page 1.11.17

Terminal optocoupler

– with bridge system

MIRO 6.2

Transistor 1 A
Screw terminals



MIRO 6.2

Transistor 1 A
Spring clamp terminals



MIRO 6.2

Transistor 2 A
Screw terminals



MIRO 6.2

Transistor 2 A
Spring clamp terminals



Circuit diagram

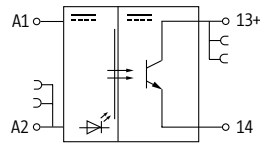

Order Data	Art-No.	Art-No.	Art-No.	Art-No.
24 V DC/6 mA	52515	cURus	6652515	
5 V DC/6 mA			cURus, cCSAus	52502
			cURus, cCSAus	6652502

Input		
Voltage range ON	11...30 V DC	4...5.5 V DC
Voltage range OFF	0...5 V DC	0...2 V DC
Control current	6 mA	
LED display	LED (yellow)	

Output		
Switching voltage	3...48 V DC	5...48 V DC
Switching current per output	500 µA...1 A	1 mA...2 A
Saturation voltage (across output)	max. 0.12 V DC	max. 0.3 V DC
Leakage current (when output is open)	max. 25 µA	max. 10 µA
Switching time ON/OFF	1.5/1 ms (100 mA load)	1/5 ms
Switching frequency	max. 40/4 Hz (resist./ind.)	max. 10/1 Hz (resist./ind.)

General data		
Test isolation voltage	500 V	2.5 kV
Temperature range	-20...+60 °C	
Mounting method	DIN-rail mountable (EN 60715)	
Housing	Black plastic, flame retardant	

Dimension drawing

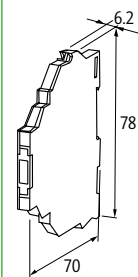
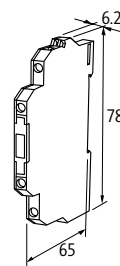
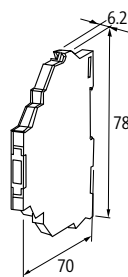
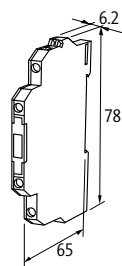

Murrelektronik Online Shop
onlineshop.murrelektronik.com/en

Notes

OPTOCOUPLEDERS / SEMICONDUCTORS

Terminal optocoupler

– with bridge system

Approvals:  

MIRO 6.2

Transistor 2 A
Screw terminals



MIRO 6.2

Transistor 2 A
Spring clamp terminals



MIRO 6.2

Transistor 2 A
Screw terminals



MIRO 6.2

Transistor 2 A
Spring clamp terminals



Circuit diagram

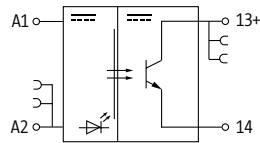

Order Data	Art-No.	Art-No.	Art-No.	Art-No.
24 V DC/6 mA	52501	6652501		
48 V DC/6 mA			52505	6652505

Input		
Voltage range ON	10...48 V DC	18...56 V DC
Voltage range OFF	0...5 V DC	0...12 V DC
Control current	6 mA	
LED display	LED (yellow)	

Output	
Switching voltage	5...48 V DC
Switching current per output	1 mA...2 A
Saturation voltage (across output)	max. 0.3 V DC
Leakage current (when output is open)	max. 10 µA
Switching time ON/OFF	1/5 ms
Switching frequency	max. 10/1 Hz (resist./ind.)

General data	
Test isolation voltage	2.5 kV
Temperature range	-20...+60 °C
Mounting method	DIN-rail mountable (EN 60715)
Housing	Black plastic, flame retardant

Dimension drawing

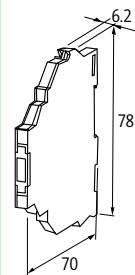
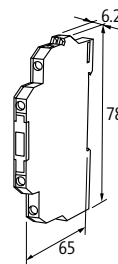
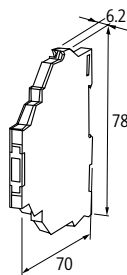
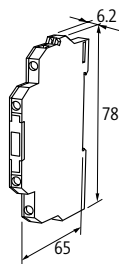

Murrelektronik Online Shop
onlineshop.murrelektronik.com/en

Notes

Terminal optocoupler

– with bridge system



MIRO 6.2

Transistor 6 A
Screw terminals



MIRO 6.2

Transistor 6 A
Spring clamp terminals



MIRO 6.2

Transistor 10 A
Screw terminals



MIRO 6.2

Transistor 10 A
Spring clamp terminals



Circuit diagram

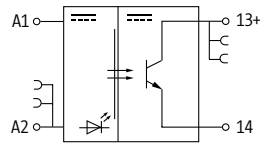

Order Data	Art-No.	Art-No.	Art-No.	Art-No.
24 V DC/6 mA	52519	6652519		
24 V DC/10 mA			52520	6652520

Input		
Voltage range ON	10...53 V DC	
Voltage range OFF	0...5 V DC	
Control current	approx. 10 mA	10 mA
LED display	LED (yellow)	
Output		
Switching voltage	5...48 V DC	
Switching current per output	1 mA...6 A (without derating)	1 mA...10 A
Saturation voltage (across output)	max. 0.1 V DC	max. 0.12 V DC
Leakage current (when output is open)	max. 25 µA	
Switching time ON/OFF	2/5 ms	2/5 ms (10 A load)
Switching frequency	max. 1/0.1 Hz (resist./ind.)	

General data		
Test isolation voltage	2.75 kV	
Temperature range	-20...+60 °C	
Mounting method	DIN-rail mountable (EN 60715)	
Housing	Black plastic, flame retardant	

Dimension drawing

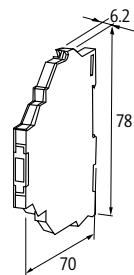
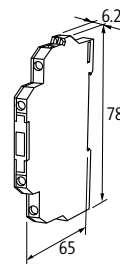
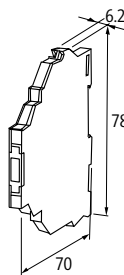
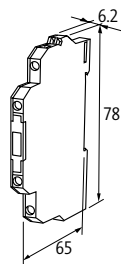

Murrelektronik Online Shop
onlineshop.murrelektronik.com/en

Notes

OPTOCOUPLEDERS / SEMICONDUCTORS

Terminal optocoupler

– with bridge system

Approvals:  

MIRO 6.2

Transistor 10 A
Screw terminals



MIRO 6.2

Transistor 10 A
Spring clamp terminals



MIRO 6.2

Transistor 0.5 A
Screw terminals



MIRO 6.2

Transistor 0.5 A
Spring clamp terminals



Circuit diagram

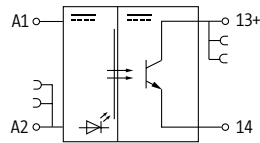

Order Data	Art-No.	Art-No.	Art-No.	Art-No.
24 V DC/10 mA (pulse control operation)	52521	6652521		
24 V DC/6 mA			52500	6652500

Input	
Voltage range ON	10...53 V DC
Voltage range OFF	0...5 V DC
Control current	10 mA
LED display	LED (yellow)

Output	
Switching voltage	5...48 V DC
Switching current per output	1 mA...10 A, overload and short circuit protection switched positive
Saturation voltage (across output)	max. 0.12 V DC
Leakage current (when output is open)	max. 25 µA
Switching time ON/OFF	2/5 ms (10 A load)
Switching frequency	max. 1 Hz

General data	
Test isolation voltage	2.75 kV
Temperature range	-20...+60 °C
Mounting method	DIN-rail mountable (EN 60715)
Housing	Black plastic, flame retardant

Dimension drawing

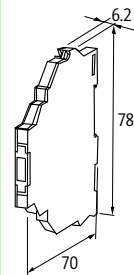
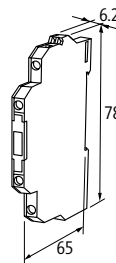
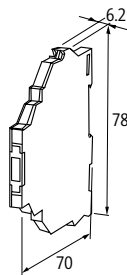
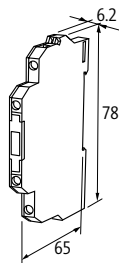

Murrelektronik Online Shop
onlineshop.murrelektronik.com/en

Notes

OPTOCOUPLEDERS / SEMICONDUCTORS

Terminal optocoupler

– with bridge system

Approvals:  

MIRO 6.2

Transistor 0.5 A
Screw terminals



MIRO 6.2

Transistor 0.5 A
Spring clamp terminals



MIRO 6.2

Transistor 0.5 A
Screw terminals



MIRO 6.2

Transistor 0.5 A
Spring clamp terminals



Circuit diagram

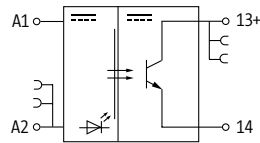

Order Data

110 V AC/DC/6 mA

Art-No.

52506

Art-No.

6652506

Art-No.

52507

Art-No.

6652507

230 V AC/6 mA

Input

Voltage range ON

70...130 V AC/DC

Voltage range OFF

0...30 V AC/DC

Control current

6 mA

LED display

LED (yellow)

Output

Switching voltage

5...48 V DC

Switching current per output

0.1 mA...0.5 A

Saturation voltage (across output)

max. 1.2 V DC

Leakage current (when output is open)

max. 0.3 mA

Switching time ON/OFF

100/700 µs

Switching frequency

max. 500/30 Hz (resist./ind.)

General data

Test isolation voltage

3.75 kV

Temperature range

-20...+60 °C

Mounting method

DIN-rail mountable (EN 60715)

Housing

Black plastic, flame retardant

Dimension drawing

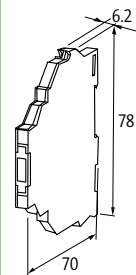
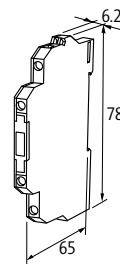
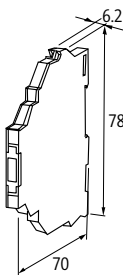
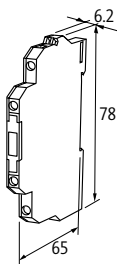

Murrelektronik Online Shop
onlineshop.murrelektronik.com/en

Notes

OPTOCOUPLEDERS / SEMICONDUCTORS

Terminal optocoupler

– with bridge system

Approvals:  

MIRO 6.2

Transistor 2 A
Screw terminals



MIRO 6.2

Transistor 2 A
Spring clamp terminals



Circuit diagram

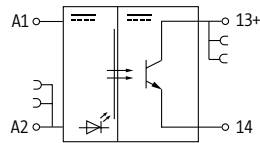

Order Data	Art-No.	Art-No.
230 V AC/6 mA	52508	6652508

Input	
Voltage range ON	90...250 V AC
Voltage range OFF	0...30 V AC
Control current	15 mA
LED display	LED (yellow)
Output	
Switching voltage	5...48 V DC
Switching current per output	1 mA...2 A (without derating)
Saturation voltage (across output)	max. 0.3 V DC
Leakage current (when output is open)	max. 0.3 mA
Switching frequency	max. 10/1 Hz (resist./ind.)
Switching time ON/OFF	3/10 ms

General data	
Test isolation voltage	2.5 kV
Temperature range	-20...+60 °C
Mounting method	DIN-rail mountable (EN 60715)
Housing	Black plastic, flame retardant

Dimension drawing

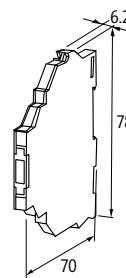
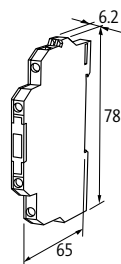

Murrelektronik Online Shop
onlineshop.murrelektronik.com/en

Notes

Terminal optocoupler

– with bridge system

Approvals:

MIRO 6.2

Transistor 2 A
Inrush current limiting
Screw terminals



MIRO 6.2

Transistor 2 A
Inrush current limiting
Spring clamp terminals



MIRO 6.2

Transistor 0.5 A
electr. NO/NC contact
Screw terminals



MIRO 6.2

Transistor 0.5 A
electr. NO/NC contact
Spring clamp terminals



Circuit diagram

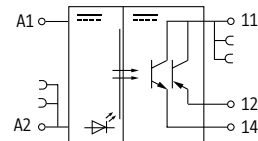
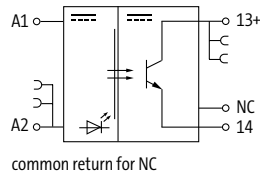

Order Data	Art-No.	Art-No.	Art-No.	Art-No.
24 V DC/6 mA	52512	6652512	52510	6652510

Input				
Voltage range ON	10...53 V DC			
Voltage range OFF	0...5 V DC			
Control current	6 mA			
LED display	LED (yellow)			
Output				
Switching voltage	5...48 V DC			
Switching current per output	1 mA...2 A overload protection		0.1 mA...0.5 A	
Saturation voltage (across output)	max. 0.35 V DC		max. 1.2 V DC	
Leakage current (when output is open)	max. 0.1 mA			
Switching time ON/OFF	5/10 ms		40/150 µs	
Switching frequency	max. 10 Hz			

General data				
Test isolation voltage	2.5 kV		3.75 kV	
Temperature range	-20...+60 °C			
Mounting method	DIN-rail mountable (EN 60715)			
Housing	Black plastic, flame retardant			

Dimension drawing

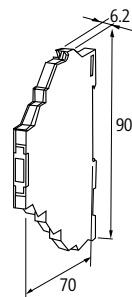
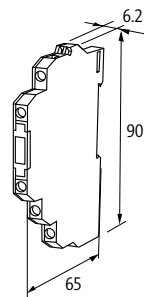
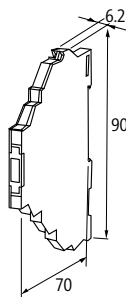
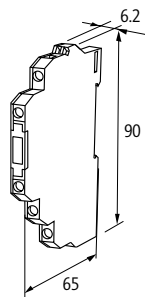

Murrelektronik Online Shop
onlineshop.murrelektronik.com/en

Notes

OPTOCOUPLEDERS / SEMICONDUCTORS

Terminal optocoupler

– with bridge system

MIRO 6.2

Transistor 0.5 A
Control current 0.1 mA (5 V DC)
Screw terminals



MIRO 6.2

Transistor 0.5 A
Control current 0.1 mA (5 V DC)
Spring clamp terminals



MIRO 6.2

Transistor 2 A
short-circuit protected
Screw terminals



MIRO 6.2

Transistor 2 A
short-circuit protected
Spring clamp terminals



Approvals:

Circuit diagram

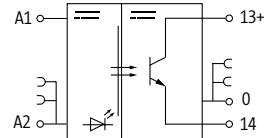
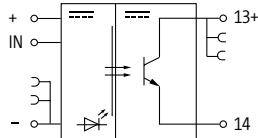

Order Data	Art-No.	Art-No.	Art-No.	Art-No.
24 V DC/0.1 mA (5 V DC)	cCSAus	52511	cCSAus	6652511
24 V DC/6 mA			52503	6652503

Input		
Voltage range ON	4.2...30 V DC	10...48 V DC
Voltage range OFF	0...2 V DC	0...5 V DC
Control current	0.1 mA (5 V)	6 mA
LED display	LED (yellow)	
Output		
Switching voltage	5...48 V DC	10...35 V DC
Switching current per output	0.1 mA...0.5 A	1 mA...2 A (short-circuit protected)
Saturation voltage (across output)	max. 1.2 V DC	
Leakage current (when output is open)	max. 0.1 mA	
Switching time ON/OFF	12/12 μs	90/120 μs
Switching frequency	max. 20 kHz	max. 1 kHz

General data	
Test isolation voltage	3.75 kV
Temperature range	-20...+60 °C
Mounting method	DIN-rail mountable (EN 60715)
Housing	Black plastic, flame retardant

Dimension drawing

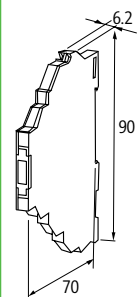
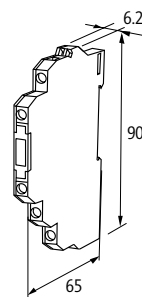
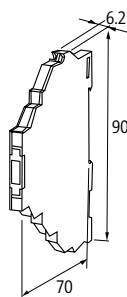
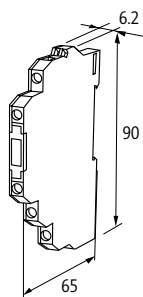

Murrelektronik Online Shop
onlineshop.murrelektronik.com/en

Notes

Terminal optocoupler

– with bridge system

MIRO 6.2

Transistor 1 A
Multi voltage output
Screw terminals



MIRO 6.2

Transistor 1 A
Multi voltage output
Spring clamp terminals



MIRO 6.2

Transistor 2 A
Spring clamp terminals

MIRO 6.2

Transistor 0.1 A
Spring clamp terminals

Circuit diagram

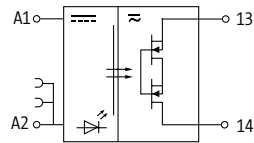

Order Data	Art-No.	Art-No.	Art-No.	Art-No.
24 V DC/10 mA	52572	6652572	526071	526100
Input				
Voltage range ON	10...53 V DC		10...35 V DC	10...30 V DC
Voltage range OFF	0...5 V DC			0...7 V DC
Control current	10 mA	6 mA		5.5 mA
LED display	LED (yellow)	LED (green)		LED (yellow)
Output				
Switching time ON/OFF	3/6 ms	7/6 µs		0.4/0.1 µs
Switching voltage	5...250 V AC/5...350 V DC	10...30 V DC		5...48 V DC
Switching current per output	1 mA...1 A	1 mA...2 A		0...0.1 A
Saturation voltage (across output)	max. 0.7 V AC/DC	max. 0.3 V AC/DC		max. 1.2 V AC/DC
Leakage current (when output is open)	max. 25 µA			max. 250 µA
Switching frequency	max. 10 Hz	max. 30 kHz/400 Hz (resist./ind.)		500 kHz (ohmic)
General data				
Test isolation voltage	2.75 kV	2.5 kV		2.75 kV
Temperature range	-20...+60 °C			
Mounting method	DIN-rail mountable (EN 60715)			
Housing	Black plastic, flame retardant			
Dimension drawing				

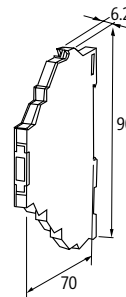
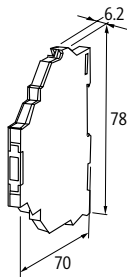
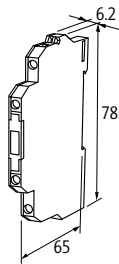

Murrelektronik Online Shop
onlineshop.murrelektronik.com/en

Notes

OPTOCOUPLEDERS / SEMICONDUCTORS

Terminal optocoupler

– Isolation function in output circuit

Approvals:  

MIRO 6.2

Transistor 2 A
Screw terminals



MIRO 6.2

Transistor 2 A
Spring clamp terminals



Circuit diagram

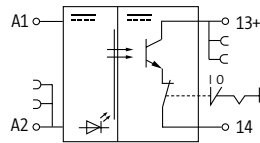

Order Data	Art-No.	Art-No.
24 V DC / 7 mA	52513	6652513

Input	
Voltage range ON	10...48 V DC
Voltage range OFF	0...5 V DC
Control current	7 mA
LED display	LED (yellow)
Output	
Switching time ON/OFF	1/5 ms
Switching current per output	1 mA...2 A
Switching voltage	5...48 V DC
Saturation voltage (across output)	max. 0.3 V DC
Leakage current (when output is open)	max. 0.3 mA
Switching frequency	max. 10/1 Hz (resist./ind.)

General data	
Temperature range	-20...+60 °C
Housing	Black plastic, flame retardant
Test isolation voltage	2.5 kV
Mounting method	DIN-rail mountable (EN 60715)

Dimension drawing

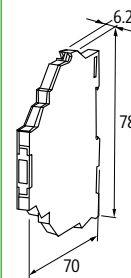
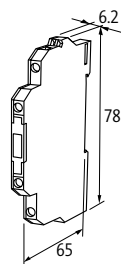

Murrelektronik Online Shop
onlineshop.murrelektronik.com/en

Notes

Optocouplers

- Inrush current limiting
- Screw terminals

AMMS

Transistor 1.2 A



EMMS

Transistor 1.2 A

Circuit diagram

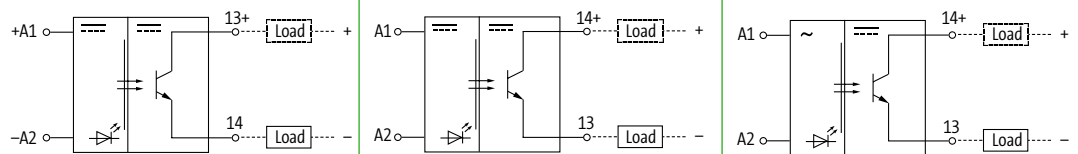

Order Data

3.5...5.5 V DC/6 mA
24 V DC/6 mA
110/230 V AC/2.7 mA

Art-No.

50041

Art-No.

50040

Art-No.

50105

Input

Voltage range ON	3.5...5.5 V DC	10...53 V DC	100...253 V AC
Voltage range OFF	0...0.8 V DC	0...3 V DC	0...40 V AC
Input current	6 mA		2.7 mA
LED display	LED (red)		

Output

Leakage current (when output is open)	max. 0.3 mA		
Switching current per output	1 mA...1.2 A		
Switching voltage	4.5...53 V DC		
Saturation voltage (across output)	max. 1.2 V DC		
Switching time ON/OFF	100/700 μ s		20/50 ms
Switching frequency	max. 500 Hz (resist.) at max. 0.2 A/max. 30 Hz (ind.)		max. 5 Hz

General data

Test isolation voltage	3.75 kV
Temperature range	-20...+60 °C
Mounting method	DIN-rail mountable TH35 or G32 (EN 60715)
Housing	Black plastic, flame retardant

Dimension drawing

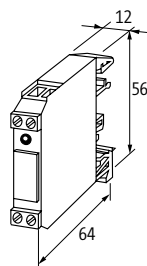

Murrelektronik Online Shop
onlineshop.murrelektronik.com/en

Notes

OPTOCOUPLEDERS / SEMICONDUCTORS

Optocouplers

- Inrush current limiting
- Screw terminals

AMMS

Transistor 1.2 A



AMMS

Transistor 2 A

Circuit diagram

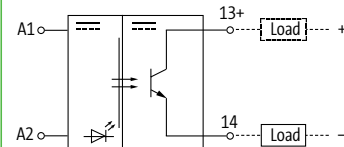
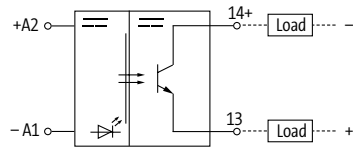

Order Data	Art-No.	Art-No.
4...30 V DC/10 mA	50010	
24 V DC/6 mA		50070
Input		
Voltage range ON	4...30 V DC	10...53 V DC
Voltage range OFF	0...2 V DC	0...3 V DC
Input current	max. 10 mA	6 mA
LED display	LED (red)	
Output		
Switching voltage	4.5...44 V DC	4.5...40 V DC
Switching current per output	1 mA...1.2 A	10 mA...2 A
Saturation voltage (across output)	max. 1.2 V DC	max. 0.1 V DC
Leakage current (when output is open)	max. 0.3 mA	max. 0.1 mA
Switching time ON/OFF	65/65 μ s	2/8 ms
Switching frequency	max. 7 kHz (resist.) at max. 0.3 A/max. 10 Hz (ind.)	max. 2.5 Hz
General data		
Test isolation voltage	3.75 kV	2.5 kV
Temperature range	-20...+60 °C	
Mounting method	DIN-rail mountable TH35 or G32 (EN 60715)	
Housing	Black plastic, flame retardant	
Dimension drawing		

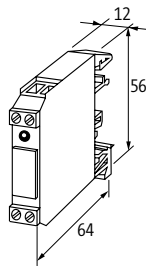

Murrelektronik Online Shop
onlineshop.murrelektronik.com/en

Notes

Optocouplers

– Double terminals on the output side

– Screw terminals

AMMDS

Transistor 0.1 A
with minus plug link



AMMDS

Transistor 2 A
with minus plug link

AMMDS

Transistor 0.1 A

Circuit diagram

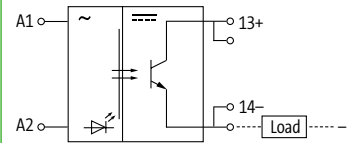
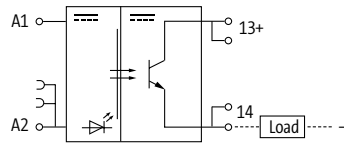

Order Data

24 V DC/6 mA

Art-No.

50081

Art-No.

50080

Art-No.

50110

230 V AC/10 mA

50110

Input

LED display	LED (red)	
Input current	6 mA	7.5 mA
Plug link (supplied)	Art.-Nr. 90960	–
Voltage range ON	10...53 V DC	195...253 V AC
Voltage range OFF	0...3 V DC	0...110 V AC

Output

Switching voltage	4...40 V DC	4...35 V DC	4...40 V DC
Switching current per output	1 mA...0.1 A	10 mA...2 A (short-circuit protected)	1 mA...0.1 A
Saturation voltage (across output)	max. 1.2 V DC	max. 0.5 V DC	max. 1.2 V DC
Leakage current (when output is open)	max. 0.3 mA		
Switching time ON/OFF	1.5/2 ms	5/15 ms	50/120 ms
Switching frequency	max. 300/40 Hz (resist./ind.)	max. 10/1 Hz (resist./ind.)	

General data

Temperature range	-20...+60 °C		
Mounting method	DIN-rail mountable TH35 or G32 (EN 60715)		
Housing	Black plastic, flame retardant		
Test isolation voltage	3.75 kV	2.5 kV	3.75 kV

Dimension drawing

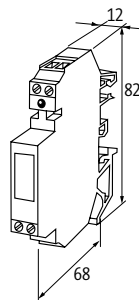

Murrelektronik Online Shop
onlineshop.murrelektronik.com/en

Notes

OPTOCOUPPLERS / SEMICONDUCTORS

Optocouplers

– with minus plug link

– Screw terminals

AMMDS

Transistor 2 A
Double terminals on the output side
for rapid switching



AMMDS

Transistor 1 A

Circuit diagram

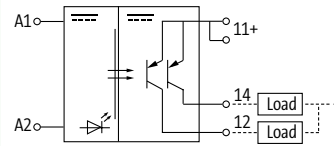
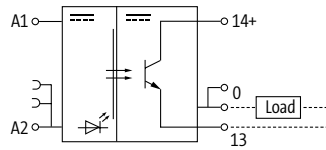

Order Data	Art-No.	Art-No.
24 V DC/15 mA	50082	
24 V AC/DC/10 mA		50085
Input		
Voltage range ON	10...35 V DC	10...53 V DC
Voltage range OFF	0...5 V DC	0...6 V DC
Input current	10 mA	
LED display	LED (red)	
Plug link (supplied)	Art.-Nr. 90960	–
Output		
Switching voltage	5...35 V DC	4.5...53 V DC
Switching current per output	1 mA...2 A	1 mA...1 A
Saturation voltage (across output)	max. 0.5 V DC	
Leakage current (when output is open)	max. 0.3 mA	
Switching time ON/OFF	7/6 µs	25/75 µs
Switching frequency	max. 30 kHz/200 Hz (resist./ind.)	max. 1 kHz/10 Hz (resist./ind.)
General data		
Test isolation voltage	2.5 kV	
Temperature range	-20...+60 °C	
Mounting method	DIN-rail mountable TH35 or G32 (EN 60715)	
Housing	Black plastic, flame retardant	
Dimension drawing		

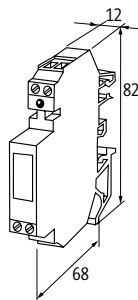

Murrelektronik Online Shop
onlineshop.murrelektronik.com/en

Notes

Power opto-coupler modules

– Screw terminals

AMS

Transistor 4 A



AMS

Transistor 2 A (3-way)
3 NO contacts



AMS

Transistor 2 A (4-way)
4 NO



Circuit diagram

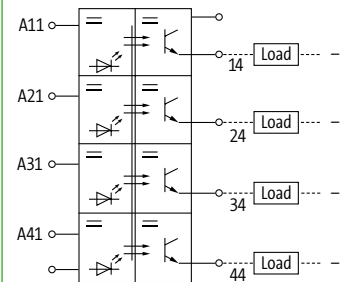
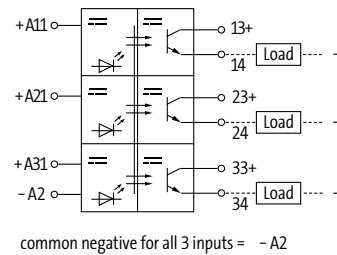
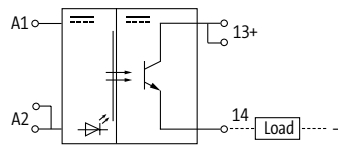

Order Data	Art-No.	Art-No.	Art-No.
24 V DC/10 mA	50044	50043	
24 V DC/3 mA			cCSAus 50015
Input			
Voltage range ON	10...53 V DC		20...30 V DC
Voltage range OFF	0...3 V DC		0...6 V DC
Input current	14.5 mA	10 mA	27 mA
LED display	LED (red)		LED (yellow)
Output			
Switching voltage	4.5...53 V DC	4.5...35 V DC	5...30 V DC
Switching current per output	100 mA...4 A	10 mA...2 A (short-circuit protected)	1 mA...2 A
Saturation voltage (across output)	max. 1.5 V AC	max. 0.5 V DC	max. 0.05 V DC
Leakage current (when output is open)	max. 10 mA	max. 0.3 mA	max. 0.01 mA
Switching time ON/OFF	4/7 µs	2/15 ms	1/5 ms
Switching frequency	max. 2 kHz/4 Hz (resist./ind.)	max. 10/1 Hz (resist./ind.)	
General data			
Test isolation voltage	3.75 kV	2.5 kV	
Temperature range	-20...+60 °C		-25...+50 °C
Mounting method	DIN-rail mountable TH35 or G32 (EN 60715)		
Housing	Black plastic, flame retardant		

Dimension drawing

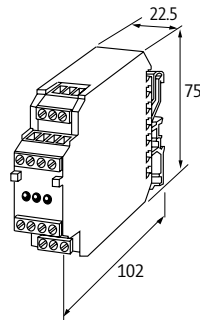

Murrelektronik Online Shop
onlineshop.murrelektronik.com/en

Notes

OPTOCOUPLEDERS / SEMICONDUCTORS

Optocouplers

- DC Motor control
- Over current / temperature monitoring

MIRO 12.4

Transistor 3 A
Screw terminals



MIRO 12.4

Transistor 3 A
Spring clamp terminals



Circuit diagram

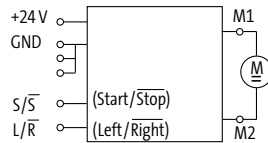

Order Data	Art-No.	Art-No.
24 V DC/10 mA	50140	6650140

Input	
Voltage range ON	15...30 V DC
Voltage range OFF	0...5 V DC
Input current	10 mA
LED display	LED (yellow): right running; LED (green): left running
Output	
Switching voltage	19.2...30 V DC
Switching current per output	max. 3 A
Highest current	approx. 6 A for 100 ms
Saturation voltage (across output)	max. 1.4 V DC
Leakage current (when output is open)	max. 10 mA
Switching time ON/OFF	1.2/10 ms
Switching frequency	max. 1 Hz (motor dependant)
Changing time	max. 50 ms
LED display	LED (red): error (over current/over heated)
General data	
Test isolation voltage	no galvanic separation
Temperature range	0...+50 °C
Mounting method	DIN-rail mountable TH35 or G32 (EN 60715)
Housing	Black plastic, flame retardant
Dimension drawing	

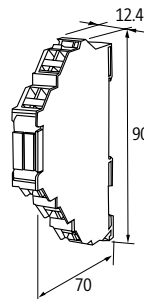
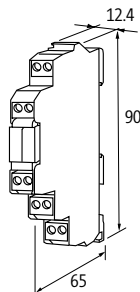

Murrelektronik Online Shop
onlineshop.murrelektronik.com/en

Notes

Terminal triac

– Zero potential switch

MIRO 6.2

Triac 0.5 A
Screw terminals



MIRO 6.2

Triac 0.5 A
Spring clamp terminals



MIRO 6.2

Triac 0.5 A
Screw terminals



MIRO 6.2

Triac 0.5 A
Spring clamp terminals



Approvals: **ULus**

Circuit diagram

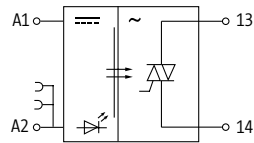

Order Data

	Art-No.	Art-No.	Art-No.	Art-No.
5 V DC/6 mA	52551	6652551		
24 V DC/6 mA			52550	6652550

Input

Voltage range ON	4...5.5 V DC	10...53 V DC
Voltage range OFF	0...2 V DC	0...5 V DC
Control current	6 mA	
LED display	LED (yellow)	

Output

Switching voltage	24...250 V AC	
Switching current per output	2 mA...0.5 A	1.5 mA...0.5 A
Saturation voltage (across output)	max. 1.5 V AC	
Leakage current (when output is open)	max. 0.3 mA	
Switching time ON/OFF	10/10 ms	
Switching frequency	max. 20 Hz, depending on suppression	

General data

Test isolation voltage	2.5 kV
Temperature range	-20...+60 °C
Mounting method	DIN-rail mountable (EN 60715)
Housing	Black plastic, flame retardant

Dimension drawing

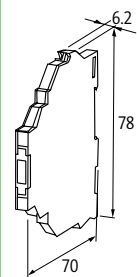
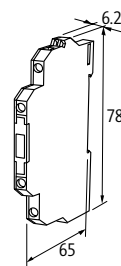
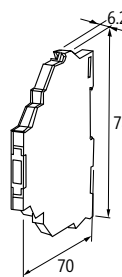
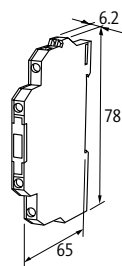

Murrelektronik Online Shop
onlineshop.murrelektronik.com/en

Notes

OPTOCOUPPLERS / SEMICONDUCTORS

Terminal triac

– Zero potential switch

MIRO 6.2

Triac 1 A
Screw terminals



MIRO 6.2

Triac 1 A
Spring clamp terminals



Circuit diagram

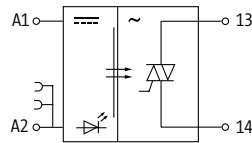

Order Data	Art-No.	Art-No.
24 V DC/9 mA	52571	6652571

Input	
Voltage range ON	12...53 V DC
Voltage range OFF	0...3 V DC
Control current	12 mA (24 V DC)
LED display	LED (yellow)
Output	
Switching voltage	12...250 V AC
Switching current per output	10 mA...1 A
Saturation voltage (across output)	max. 1.5 V AC
Leakage current (when output is open)	max. 1 mA
Switching time ON/OFF	10/10 ms
Switching frequency	max. 2 Hz, depending on suppression

General data	
Test isolation voltage	2.5 kV
Temperature range	0...+60 °C
Mounting method	DIN-rail mountable (EN 60715)
Housing	Black plastic, flame retardant

Dimension drawing

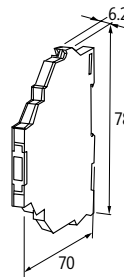
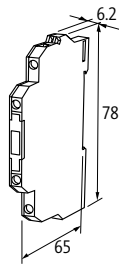

Murrelektronik Online Shop
onlineshop.murrelektronik.com/en

Notes

Terminal triac

– Zero potential switch

MIRO 6.2

Triac 0.5 A
Screw terminals



MIRO 6.2

Triac 0.5 A
Spring clamp terminals



MIRO 6.2

Triac 0.5 A
Screw terminals



MIRO 6.2

Triac 0.5 A
Spring clamp terminals



Approvals: **ULus**

Circuit diagram

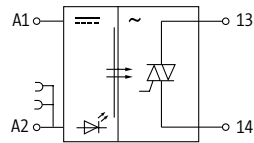

Order Data

110 V AC/DC (95...121VAC/DC - 4 mA)
230 V AC/7 mA

Art-No.
52556

Art-No.
6652556

Art-No.
52557

Art-No.
6652557

Input

Voltage range ON	70...130 V AC/DC	140...250 V AC
Voltage range OFF	0...35 V AC/DC	0...80 V AC
Control current	4 mA	7 mA

LED display: LED (yellow)

Output

Switching voltage	12...250 V AC	
Switching current per output	2 mA...0.5 A	
Saturation voltage (across output)	max. 1.5 V AC	
Leakage current (when output is open)	max. 0.3 A	max. 0.3 mA
Switching time ON/OFF	10/10 ms	
Switching frequency	max. 20 Hz, depending on suppression	

General data

Test isolation voltage	2.5 kV
Temperature range	-20...+60 °C
Mounting method	DIN-rail mountable (EN 60715)
Housing	Black plastic, flame retardant

Dimension drawing

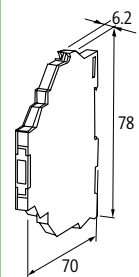
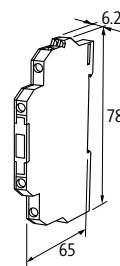
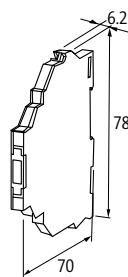
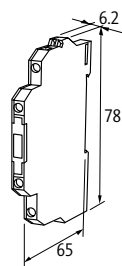

Murrelektronik Online Shop
onlineshop.murrelektronik.com/en

Notes

OPTOCOUPLEDERS / SEMICONDUCTORS

Terminal triac

– Zero potential switch

MIRO 6.2

Triac 0.5 A
Screw terminals



MIRO 6.2

Triac 0.5 A
Spring clamp terminals



Circuit diagram

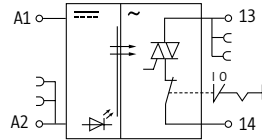

Order Data	Art-No.	Art-No.
24 V DC / 7 mA	52561	6652561

Input	
Voltage range ON	10...53 V DC
Voltage range OFF	0...5 V DC
Control current	7 mA
LED display	LED (yellow)
Output	
Switching voltage	24...250 V AC
Switching current per output	2 mA...0.5 A
Saturation voltage (across output)	max. 1.5 V AC
Leakage current (when output is open)	max. 0.3 mA
Switching time ON/OFF	10/10 ms
Switching frequency	max. 20/1 Hz (resist./ind.)
General data	
Test isolation voltage	2.5 kV
Temperature range	-20...+60 °C
Mounting method	DIN-rail mountable (EN 60715)
Housing	Black plastic, flame retardant

Dimension drawing

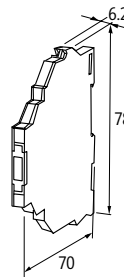
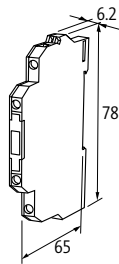

Murrelektronik Online Shop
onlineshop.murrelektronik.com/en

Notes

Triac modules MIRO

- Zero potential switch
- Screw plug-in terminals

MIRO Triac

Triac 5 A



Circuit diagram

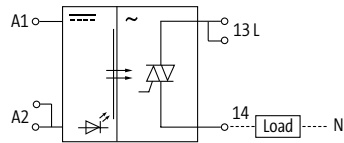

Order Data	Art-No.	Art-No.	Art-No.
24 V DC / 7.8 mA	3000-36001-2000020		
115 V AC / 9 mA		3000-36001-2000022	
230 V AC / DC - 10 mA			3000-36001-3000023
Input			
Voltage range ON	10...53 V DC	70...150 V AC	140...253 V AC
Voltage range OFF	0...3 V DC	0...25 V AC	0...50 V AC
Control current	approx. 7.8 mA	approx. 9 mA	approx. 10 mA
Control voltage	24 V DC	115 V AC	230 V AC
LED display	LED (green)		
Output			
Switching voltage	12...400 V AC		
Switching current per output	10 mA...5 A (no derating)		
Saturation voltage (across output)	max. 0.15 V AC		
Leakage current (when output is open)	max. 1 mA		
Switching time ON/OFF	10/10 ms		
Switching frequency	max. 20/1 Hz (resist./ind.)		
Surge current	70 A		
General data			
Temperature range	-20...+60 °C		
Housing	Black plastic, flame retardant		
Mounting method	DIN-rail mountable (EN 60715)		
Dimension drawing			

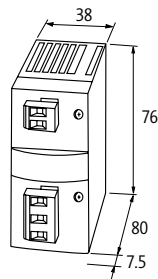

Murrelektronik Online Shop
onlineshop.murrelektronik.com/en

Notes

OPTOCOUPLEDERS / SEMICONDUCTORS

Triac modules MIRO

- Zero potential switch
- Screw plug-in terminals

MIRO Triac

Triac 10 A



Circuit diagram

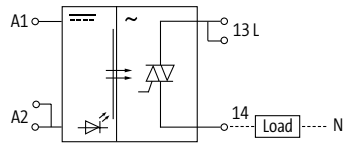

Order Data	Art-No.	Art-No.	Art-No.
24 V DC / 7.8 mA	3000-36001-2000025		
115 V AC / 9 mA		3000-36001-2000027	
230 V AC / DC - 10 mA			3000-36001-3000028

Input			
Voltage range ON	10...53 V DC	70...150 V AC	140...253 V AC
Voltage range OFF	0...3 V DC	0...25 V AC	0...50 V AC
Control current	approx. 7.8 mA	approx. 9 mA	approx. 10 mA
Control voltage	24 V DC	115 V AC	230 V AC
LED display	LED (green)		

Output	
Switching voltage	12...400 V AC
Switching current per output	100 mA / 10 A (no derating)
Saturation voltage (across output)	max. 0.15 V AC
Leakage current (when output is open)	max. 1 mA
Switching time ON/OFF	10/10 ms
Switching frequency	max. 20/1 Hz (resist./ind.)
Surge current	70 A

General data	
Temperature range	-20...+60 °C
Housing	Black plastic, flame retardant
Mounting method	DIN-rail mountable (EN 60715)

Dimension drawing

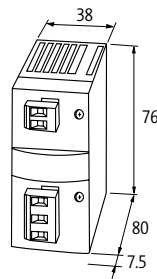

Murrelektronik Online Shop
onlineshop.murrelektronik.com/en

Notes

Triac modules

- Zero potential switch
- Screw terminals

AMS
Triac 4 A



Circuit diagram

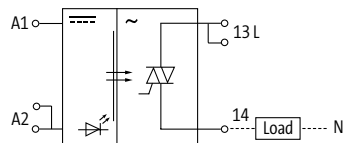

Order Data

24 V DC / 10 mA

Art-No.

50034

Input

Voltage range ON 10...53 V DC

Voltage range OFF 0...3 V DC

Input current 10 mA

LED display LED (red)

Output

Switching voltage 24...250 V AC

Switching current per output 10 mA...4 A

Saturation voltage (across output) max. 1.4 V AC

Leakage current (when output is open) max. 10 mA

Switching time ON/OFF 10/10 ms

Switching frequency max. 30/5 Hz (resist./ind.)

General data

Test isolation voltage 6 kV

Temperature range -20...+60 °C

Mounting method DIN-rail mountable TH35 or G32 (EN 60715)

Housing Black plastic, flame retardant

Dimension drawing

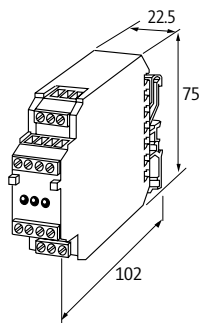

Murrelektronik Online Shop
onlineshop.murrelektronik.com/en

Notes

OPTOCOUPLEDERS / SEMICONDUCTORS

Triac modules

- Zero potential switch
- Screw terminals

AMMS

Triac 1 A



AMMDS

Triac 2 A
with minus plug link



Circuit diagram

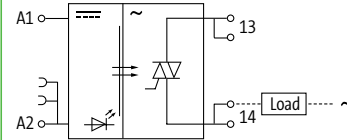
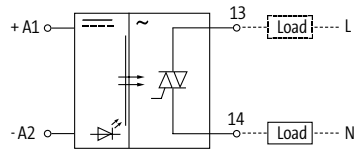

Order Data	Art-No.	Art-No.
24 V DC/6 mA	50030	50092
Input		
Voltage range ON	10...53 V DC	10...35 V DC
Voltage range OFF	0...3 V DC	
Input current	6.6 mA	6 mA
LED display	LED (red)	
Plug link (supplied)	-	Art-Nr. 90960
Output		
Switching voltage	24...253 V AC	24...280 V AC
Switching current per output	50 mA...1 A	50 mA...2 A
Saturation voltage (across output)	max. 1.3 V AC	max. 1 V AC
Leakage current (when output is open)	max. 5 mA	max. 2 mA
Switching time ON/OFF	10/10 ms	
Switching frequency	max. 20 Hz	max. 20/5 Hz (resist./ind.)
General data		
Test isolation voltage	2.5 kV	
Temperature range	-20...+60 °C	
Mounting method	DIN-rail mountable TH35 or G32 (EN 60715)	
Housing	Black plastic, flame retardant	
Dimension drawing		

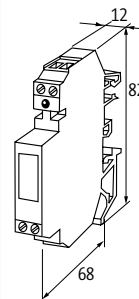
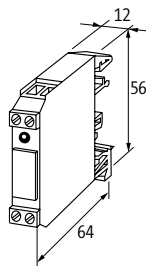

Murrelektronik Online Shop
onlineshop.murrelektronik.com/en

Notes

Labeling accessories			Art-No.
	ACS label plate KM 5 for self marking (9 × 20 mm)		7000-99001-0000000
	Label plate KM 4 5 × 10 mm		90931
	ACS label plate KM 6/18 for self marking with ADEMARK markers		7000-99003-0000000
	Label plate KWI 5/15 (88 pieces per plate)		90901
Wiring accessories			Art-No.
	Potential plug link max. 50 V/2 A	MIRO	90961
	Potential plug link max. 48 V/2 A	RMM..., RMMD...	90960
	Potential rail blue 40-pole, spacing 12 mm	RMM..., RMMD...	90970
	10-pole, spacing 6.2 mm	MIRO 6.2 (screw terminals)	90975
	Potential rail red 40-pole, spacing 12 mm	RMM..., RMMD...	90971
	10-pole, spacing 6.2 mm	MIRO 6.2 (screw terminals)	90976
	End caps for potential rail blue	MIRO 6.2	90980
	red	RMM..., RMMD...	90982

OPTOCOUPERS / SEMICONDUCTORS

Wiring accessories			Art-No.
	Wire chain 16-pole Connection cable left and right approx. 50 cm; bk; 1 mm ²	MIRO (spring clamp terminals)	90977

NOTES

A large grid of small dots for taking notes, consisting of 20 columns and 30 rows.



ACTIVE INTERFACE TECHNOLOGY

ANALOG AND DIGITAL

- Solid state or relay outputs are short circuit protected
- LED display
- DIN rail mounting

CONVERT MEASURED VALUES INTO SIGNALS

While measuring, positioning or checking systems, the status of the machine or installation should be monitored. The measured values have to be converted into digital or standard signals (0...20 mA, 4...20 mA or 0...10V) so that PLCs and computers can process them.

Murrelektronik offers a wide range of intelligent interface modules that enable signal conversion or signal acquisition with galvanic separation.

Active Interface Technology



Converters

AD/DA converters, Analog converters, Frequency converters, U/I converters

Page 1.12.1



Timer

MIRO 6.2 Timer

Page 1.12.9



Comparator modules

MAK

Page 1.12.14



Temperature converter

MTW

Page 1.12.15



Switches

Tree

Page 1.12.16



Further

Brake rectifiers, Demagnetizer, MIRO GSM

Page 1.12.18

ACTIVE INTERFACE TECHNOLOGY

AD/DA converters

- Input and output galvanically separated
- Screw terminals

MAW

A/D converter



MDW

D/A converter



Circuit diagram

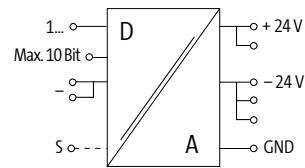
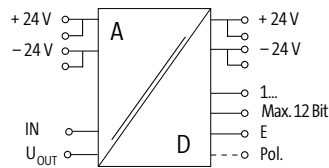

Order Data	Art-No.	Art-No.
4...20 mA/8 Bit	44091	44073
0...10 V DC/8 Bit	44062	44067
0...10 V DC/10 Bit	44063	44068

Technical Data		
Operating voltage	2 x 21...30 V DC, smoothed (with LED)	21...30 V DC, smoothed (with LED)
Operating current	60 mA (idle load) plus max. 100 mA per digital output	100 mA (idle load), max. 150 mA (full load)
Tolerance	±1 LSB	±1 %
Conversion time	80 ms, (6 Bit adjustable 2.5...150 ms)	-
Release input E	log 1 ≥ 16 V, log 0 ≤ 6 V	
Input		
Input current	type dependent	max. 10 mA/Bit
Input signal	type dependent	0...30 V DC (with LED display)
Output		
Output current	100 mA/Bit, with LED	max. 40 mA (0...10 V DC); max. 20 mA (0...20 mA), 4...20 mA
General data		
Test isolation voltage	2.5 kV	
Temperature range	0...+85 °C	0...+50 °C
Mounting method	DIN-rail mountable (EN 60715)	

Description		
Functional description	On modules with voltage inputs, it is possible to set the maximum input signal using a trimmer. The output "POL" indicates the polarity. A voltage output Uout 15 V/20 mA (minimal ripple) can be used as a power supply for the analog output device. The hold input E will sample and hold the analog value. When E is set to HIGH the outputs will show the last measured value. When E is set to LOW the converter will run again.	The maximum output signal of converters with voltage output can be adjusted to the operating voltage minus 2 V. The outputs are short-circuit protected and overload protected due to internal current limiting.

Dimension drawing

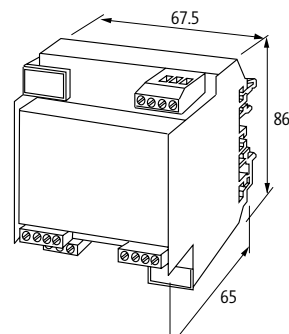
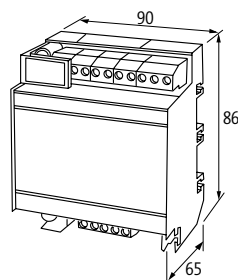

Murrelektronik Online Shop
onlineshop.murrelektronik.com/en

Notes

ACTIVE INTERFACE TECHNOLOGY

Voltage converter

– Input and output galvanically separated

MU..W 6.2 Voltage (U)

INPUT: 0...10 V DC
with bridge system
Screw terminals



MU..W 6.2 Voltage (U)

INPUT: 0...10 V DC
with bridge system
Spring clamp terminals



Circuit diagram

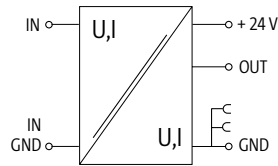

Order Data	Art-No.	Art-No.	Art-No.	Art-No.	Art-No.	Art-No.
OUTPUT: 0...10 V DC / 20 mA	44205			6644205		
OUTPUT: 0...20 mA		44232			6644232	
OUTPUT: 4...20 mA			44233			6644233

Technical Data

Operating voltage	24 V DC $\pm 20\%$, smoothed					
Operating current	50...70 mA					
Tolerance	max. 0.5 %					
Frequency	max. 500 Hz					

Voltage inputs

Input resistor	approx. 200 kOhm	approx. 250 kOhm	approx. 200 kOhm	approx. 250 kOhm	approx. 200 kOhm
----------------	------------------	------------------	------------------	------------------	------------------

Voltage output signals

Load	max. 25 mA					
------	------------	--	--	--	--	--

Current outputs

Load	max. 500 Ohm					
------	--------------	--	--	--	--	--

General data

Test isolation voltage	1.5 kV		2.5 kV	1.5 kV	
Temperature range	0...+60 °C				
Mounting method	DIN-rail mountable (EN 60715)				

Description

Functional description: The Murrelektronik analog converters convert standard signal formats (0...10 V, 0...20 mA, 4...20 mA) galvanically separated into one of these signal formats. Due to an integrated current limiter the output is short-circuit and overload protected. Module MIIW – 0/4...20 mA to 0/4...20 mA – without auxiliary supply

Dimension drawing

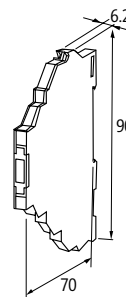
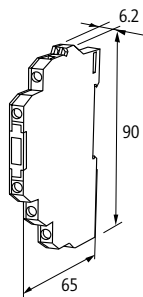

Murrelektronik Online Shop
onlineshop.murrelektronik.com/en

Notes

ACTIVE INTERFACE TECHNOLOGY

Voltage converter

– Input and output galvanically separated

MPUUW

INPUT: 0...10 V DC
Screw terminals



Circuit diagram

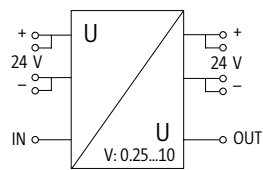

Regular voltage amplification

Order Data

OUTPUT: 0...10 V DC/300 mA

Art-No.

44201

Technical Data

Operating voltage	24 V DC $\pm 20\%$, smoothed
Operating current	max. 300 mA
Tolerance	max. 0.5 %
Frequency	max. 1 kHz

Voltage inputs

Input resistor approx. 10 kOhm

Voltage output signals

Load max. 300 mA

General data

Temperature range 0...+50 °C
Mounting method DIN-rail mountable (EN 60715)

Dimension drawing

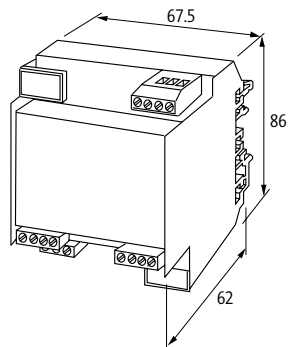

Murrelektronik Online Shop
onlineshop.murrelektronik.com/en

Notes

ACTIVE INTERFACE TECHNOLOGY

Current converter

– Input and output galvanically separated

MI..W 6.2 current (I)

INPUT: 0...20 mA
Screw terminals



MI..W 6.2 current (I)

INPUT: 0...20 mA
Spring clamp terminals



Circuit diagram

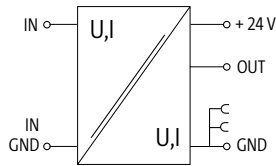

Order Data	Art-No.	Art-No.	Art-No.	Art-No.	Art-No.	Art-No.
OUTPUT: 0...10 V DC / 20 mA	44212			6644212		
OUTPUT: 0...20 mA		44226			6644226	
OUTPUT: 4...20 mA			44228			6644228

Technical Data

Operating voltage	24 V DC \pm 20 %, smoothed
Operating current	50...70 mA
Tolerance	max. 0.5 %
Frequency	max. 500 Hz

Current input signals

Load	approx. 250 Ohm
------	-----------------

Voltage output signals

Load	max. 25 mA
------	------------

Current outputs

Load	max. 500 Ohm
------	--------------

General data

Test isolation voltage	1.5 kV
Temperature range	0...+60 °C
Mounting method	DIN-rail mountable (EN 60715)

Description

Functional description	The Murrelektronik analog converters convert standard signal formats (0...10 V, 0...20 mA, 4...20 mA) galvanically separated into one of these signal formats. Due to an integrated current limiter the output is short-circuit and overload protected. Module MIIW – 0/4...20 mA to 0/4...20 mA – without auxiliary supply
------------------------	---

Dimension drawing

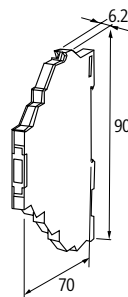
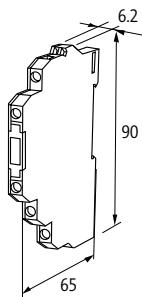

Murrelektronik Online Shop
onlineshop.murrelektronik.com/en

Notes

ACTIVE INTERFACE TECHNOLOGY

Current converter

– Input and output galvanically separated

MI..W 6.2 current (I)

INPUT: 4...20 mA
Screw terminals



MI..W 6.2 current (I)

INPUT: 4...20 mA
Spring clamp terminals



Circuit diagram

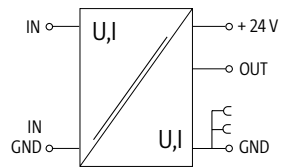

Order Data

OUTPUT: 0...10 V DC/20 mA

Art-No.

44213

Art-No.

6644213

Technical Data

Operating voltage	24 V DC \pm 20 %, smoothed
Operating current	50...70 mA
Tolerance	max. 0.5 %
Frequency	max. 500 Hz

Current input signals

Load approx. 250 Ohm

Voltage output signals

Load max. 25 mA

General data

Test isolation voltage	1.5 kV
Temperature range	0...+60 °C
Mounting method	DIN-rail mountable (EN 60715)

Description

Functional description
The Murrelektronik analog converters convert standard signal formats (0...10 V, 0...20 mA, 4...20 mA) galvanically separated into one of these signal formats. Due to an integrated current limiter the output is short-circuit and overload protected. Module MIIW – 0/4...20 mA to 0/4...20 mA – without auxiliary supply

Dimension drawing

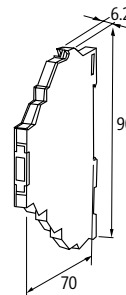
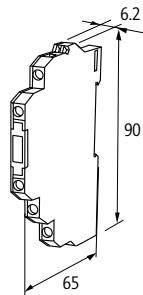

Murrelektronik Online Shop
onlineshop.murrelektronik.com/en

Notes

ACTIVE INTERFACE TECHNOLOGY

Analog converter

– Input, output, and supply voltage galvanically separated

MULTI Converter 12.4

INPUT: 0...5 V DC, 0...10 V DC, ±10 V DC
 INPUT: 0...20 mA, 4...20 mA
 Screw terminals



MULTI Converter 12.4

INPUT: 0...5 V DC, 0...10 V DC, ±10 V DC
 INPUT: 0...20 mA, 4...20 mA
 Spring clamp terminals



Circuit diagram

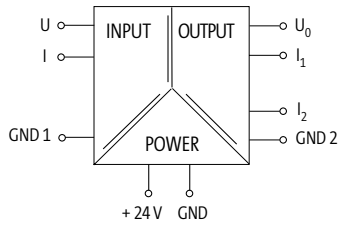

Order Data	Art-No.	Art-No.
OUTPUT: 0...10 V DC/20 mA	44207	6644207
OUTPUT: 0...20 mA	44207	6644207
OUTPUT: 4...20 mA	44207	6644207

Technical Data

Operating voltage	24 V DC ±15 %
Operating current	approx. 50 mA
Tolerance	max. 0.5 %
Frequency	max. 25 Hz

Voltage inputs

Input voltage	0...5, 0...10, ±10 V DC
Input resistor	approx. 100 kOhm

Current input signals

Input current	0...20 mA, 4...20 mA
Load	approx. 75 Ohm

Current outputs

Load	max. 400 Ohm
------	--------------

General data

Test isolation voltage	0.75 kV
Temperature range	-25...+50 °C
Mounting method	DIN-rail mountable (EN 60715)

Description

Functional description
 Due to an integrated current limiter on the output, the output is short circuit and overload protected. A special characteristic of the MULTI Converter Art-No. 6644207 includes: Analog voltage signals 0...5 V/0...10 V and -10...+10 V and current signals 0...20 mA and 4...20 mA, these compact modules can be galvanically isolated in the three standard signals, which means all combinations are covered with one model. The selection of the input is done by means of a 5-pole rotary switch, accessible under the identification tag. The voltage supply is galvanically isolated from the input and output circuits (3-way isolation).

Dimension drawing

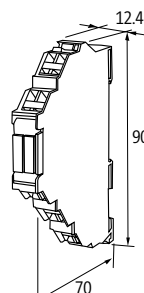
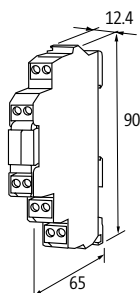

Murrelektronik Online Shop
onlineshop.murrelektronik.com/en

Notes

Analog converter

– Input, output, and supply voltage galvanically separated

MUUW

INPUT: $\pm 0 \dots 10$ V DC

OUTPUT: $\pm 0 \dots 10$ V

Screw terminals



Circuit diagram

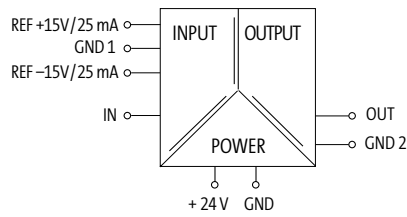

Order Data

OUTPUT: $\pm 0 \dots 10$ V DC

Art-No.

44203

Technical Data

Operating voltage 24 V DC (+15/-10 %)

Operating current max. 200 mA

Tolerance ± 1 %

Frequency 5 kHz, sine wave

Current outputs

Load max. 400 Ohm

General data

Test isolation voltage 1.5 kV

Temperature range 0...+50 °C

Mounting method DIN-rail mountable (EN 60715)

Dimension drawing

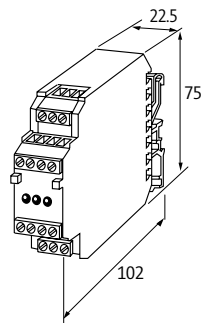

Murrelektronik Online Shop
onlineshop.murrelektronik.com/en

Notes

ACTIVE INTERFACE TECHNOLOGY

Frequency converter

– Input and output galvanically separated

M..FW 12.4

INPUT: 0...10 V DC, 0...20 mA, 4...20 mA
Screw terminals



M..FW 12.4

INPUT: 0...10 V DC, 0...20 mA, 4...20 mA
Spring clamp terminals



MF...W 12.4

INPUT: 0...1 kHz, 0...10 kHz, 0...100 kHz
Screw terminals



MF...W 12.4

INPUT: 0...1 kHz, 0...10 kHz, 0...100 kHz
Spring clamp terminals



Circuit diagram

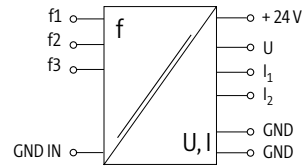
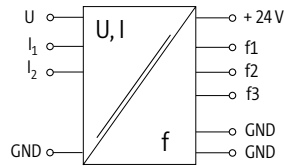

Order Data	Art-No.	Art-No.	Art-No.	Art-No.
0...1 kHz, 0...10 kHz, 0...100 kHz	44245	6644245		
0...10 V DC, 0...20 mA, 4...20 mA			44275	6644275

Technical Data

Operating voltage	24 V DC ±20 %	
Operating current	max. 60 mA	max. 80 mA
Tolerance	0.5 % from end value	
Response time	–	max. 350 ms
Voltage inputs		
Input voltage	0...10 V DC	10...30 V DC
Input resistor	approx. 100 kOhm	–
Current input signals		
Input current	0...20 mA, 4...20 mA	6...25 mA
Input resistor	approx. 75 Ohm	approx. 1.2 kOhm
Voltage output signals		
Output signal	0...1 kHz, 0...10 kHz, 0...100 kHz	0...10 V DC, 0...20 mA, 4...20 mA
Output voltage	0.5 V (short-circuit protected)	–
General data		
Test isolation voltage	1.5 kV	2.5 kV
Temperature range	-25...+50 °C	
Mounting method	DIN-rail mountable (EN 60715)	

Description

Functional description	The new frequency converter in the slim MIRO housing can be universally used. An analog voltage or current, on one of the three inputs, is galvanically isolated, transformed and is at the same time available as square wave voltage (frequency) on all three outputs. The output frequencies are through a 4-pole switch separable in relation to 1:2, 1:4 and 1:8.	The new frequency converter in the slim MIRO housing can be universally used. The frequency that is applied on the three inputs, will be galvanically isolated, transformed and is available as analog signal on all three outputs.
------------------------	--	---

Dimension drawing

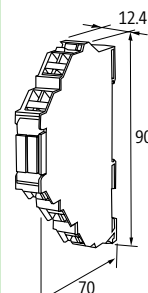
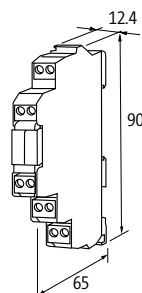
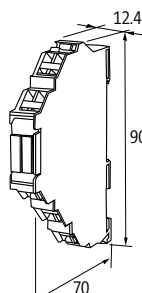
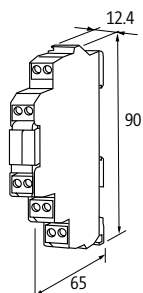

Murrelektronik Online Shop
onlineshop.murrelektronik.com/en

Notes

Timer

– Relay output

– with bridge system

Approvals:

MIRO 6.2 Timer

Switch-on delay
Screw terminals



MIRO 6.2 Timer

Switch-on delay
Spring clamp terminals



MIRO 6.2 Timer

Switch-off delay
Screw terminals



MIRO 6.2 Timer

Switch-off delay
Spring clamp terminals



Circuit diagram

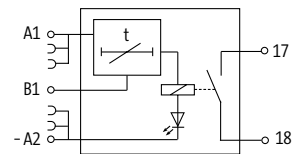
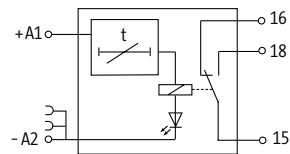

Order Data

	Art-No.	Art-No.	Art-No.	Art-No.
0.1...10 s	52300	6652300	52310	6652310
3...300 s	52301	6652301	52311	6652311

Switching capacity (EN 60947-5-1)

AC-12	6 A (24 V AC; 110 V AC; 230 V AC)
AC-15	3 A (24 V AC; 110 V AC; 230 V AC)
DC-13	1 A (24 V DC); 0.2 A (110 V DC); 0.1 A (230 V DC)

Input

Input voltage	24 V DC (+10 -15 %) input A
Input current	20 mA (input A)
Control voltage	24 V DC (+10 -15 %) input B
Control current	5 mA (input B)

Output

Output voltage	max. 250 V AC/DC
Output current	max. 6 A
Min. load current	10 mA (12 V DC)
Output rating	max. 1500 VA/120 W
Switching frequency	max. 10 Hz
Contact material	Ag Sn O ₂
Energize/release/contact bounce time	10/15/1.5 ms

General data

Mech./ elect. life	20.000.000 switching cycles/load dependant
Test isolation voltage	4 kV; safe separation (EN 60947-1)
Temperature range	0...+55 °C
Mounting method	DIN-rail mountable (EN 60715)

Functional diagram

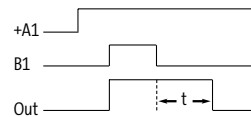
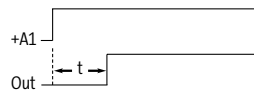

Dimension drawing

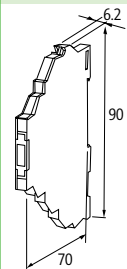
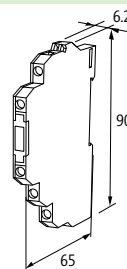
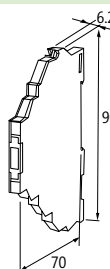
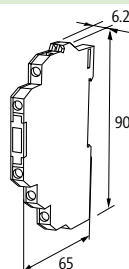

Murrelektronik Online Shop
onlineshop.murrelektronik.com/en

Notes

ACTIVE INTERFACE TECHNOLOGY

Timer

- Transistor output
- with bridge system

Approvals:  

MIRO 6.2 Timer

Impulse expansion
Screw terminals



MIRO 6.2 Timer

Impulse expansion
Spring clamp terminals



Circuit diagram

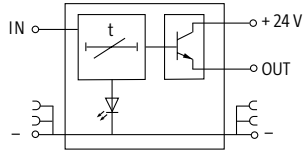

Order Data	Art-No.	Art-No.
0.1...10 s	52320	6652320

Input	
Input voltage	19...29 V DC
Control voltage	16...32 V DC
Time range	0.1...10 s
Impulse length	min. 0.5 ms

Output	
Switching voltage	Operating voltage - 1.5 V
Switching current per output	max. 100 mA

General data	
Test isolation voltage	no galvanic separation
Temperature range	0...+60 °C
Mounting method	DIN-rail mountable (EN 60715)

Functional diagram

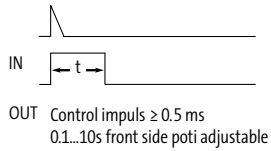

Dimension drawing

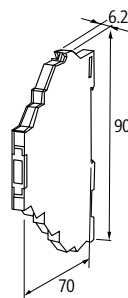
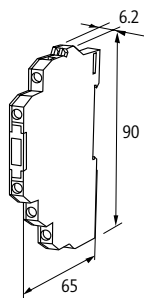

Murrelektronik Online Shop
onlineshop.murrelektronik.com/en

Notes

ACTIVE INTERFACE TECHNOLOGY

Timer

– Switch-on delay

– Switch-off delay

Approvals:   

MIRO 6.2 Timer

multifunctional
Screw terminals



MIRO 6.2 Timer

multifunctional
Spring clamp terminals



Circuit diagram

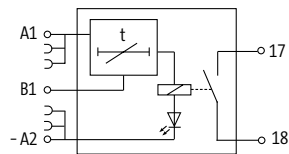

Order Data

0.1...300 s

Art-No.

52350

Art-No.

6652350

Input

Input voltage 24 V DC (+10 -15 %) input A

Input current 20 mA (input A)

Control voltage 24 V DC (+10 -15 %) input B

Control current 5 mA (input B)

Output

Output voltage max. 250 V AC/DC

Output current max. 6 A

Min. load current 10 mA (12 V DC)

Output rating max. 1500 VA/120 W

Switching frequency max. 10 Hz

Contact material Ag Sn O2

Energize/release/contact bounce time 10/15/1.5 ms

General data

Mech./ elect. life 20.000.000 switching cycles/load dependent

Test isolation voltage 4 kV; safe separation (EN 60947-1)

Temperature range 0...+55 °C

Mounting method DIN-rail mountable (EN 60715)

Functional diagram

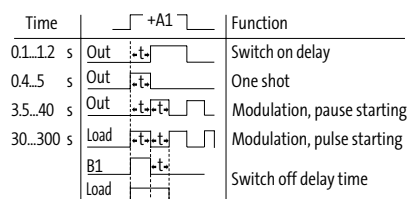

Dimension drawing

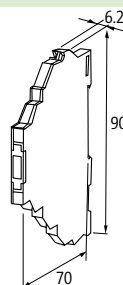
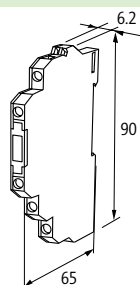

Murrelektronik Online Shop
onlineshop.murrelektronik.com/en

Notes

ACTIVE INTERFACE TECHNOLOGY

- Timer**
- Switch-on delay
 - Switch-off delay
 - Changeover contact
 - Memory function

MIRO 6.2 Timer

Transistor output
Screw terminals



MIRO 6.2 Timer

Transistor output
Spring clamp terminals



Circuit diagram

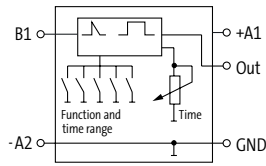

Order Data	Art-No.	Art-No.
10 ms...0.1 s	3000-18502-0200010	3000-18512-0200010
10 ms...1 s	3000-18502-0200010	3000-18512-0200010
10 ms...10 s	3000-18502-0200010	3000-18512-0200010
10 ms...100 s	3000-18502-0200010	3000-18512-0200010

Input	
Input voltage	18...30 V DC
Control voltage	18...30 V DC
Output	
Switching voltage	Operating voltage – 0.2 V
Switching current per output	max. 100 mA
Min. load current	1 mA (short-circuit protected)
Switching frequency	max. 50 Hz
General data	
Test isolation voltage	no galvanic separation
Temperature range	-20...+60 °C
Mounting method	DIN-rail mountable (EN 60715)

Dimension drawing

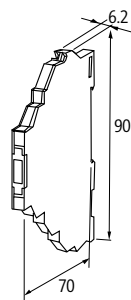
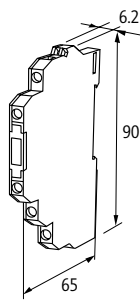

Murrelektronik Online Shop
onlineshop.murrelektronik.com/en

Notes

ACTIVE INTERFACE TECHNOLOGY

Timer

- Switch-on delay
- Switch-off delay
- Changeover contact
- Memory function

MIRO 6.2 Timer

Relay output
Screw terminals



MIRO 6.2 Timer

Relay output
Spring clamp terminals



Circuit diagram

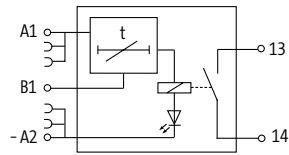

Order Data

	Art-No.	Art-No.
100 ms...1 s	3000-18503-0200012	3000-18513-0200013
100 ms...10 s	3000-18503-0200012	3000-18513-0200013
100 ms...100 s	3000-18503-0200012	3000-18513-0200013
100 ms...1000 s	3000-18503-0200012	3000-18513-0200013

Switching capacity (EN 60947-5-1)

AC-12	6 A (24 V AC; 110 V AC; 230 V AC)
AC-15	3 A (24 V AC; 110 V AC; 230 V AC)
DC-13	1 A (24 V DC); 0.2 A (110 V DC); 0.1 A (230 V DC)

Input

Input voltage	18...30 V DC
Control voltage	18...30 V DC

Output

Switching voltage	max. 250 V AC/DC
Switching current per output	max. 6 A
Min. load current	10 mA
Switching frequency	max. 5 Hz
Contact material	Ag Sn O2
Energize/release/contact bounce time	19/15/1.5 ms

General data

Mech./ elect. life	20.000.000 switching cycles/load dependent
Test isolation voltage	4 kV; safe separation (VDE 0106/ VDE 0160)
Temperature range	-20...+60 °C
Mounting method	DIN-rail mountable (EN 60715)

Dimension drawing

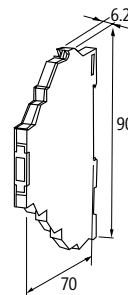
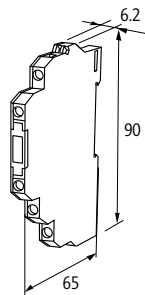

Murrelektronik Online Shop
onlineshop.murrelektronik.com/en

Notes

ACTIVE INTERFACE TECHNOLOGY

Comparator modules

– with bridge system

MAK 12.4

Input signal, voltage DC
selectable via DIP switch
Screw terminals



MAK 12.4

Input signal, voltage DC
selectable via DIP switch
Spring clamp terminals



Circuit diagram

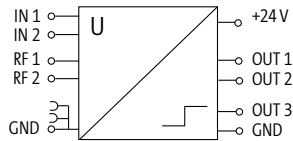

Order Data	Art-No.	Art-No.
24 V DC/0.7 A	44110	6644110

Technical Data	
Operating voltage	20...30 V DC, smoothed
Operating current	30 mA (idle load), max. 0.8 A (full load)
Time constant	approx. 10 ms
Input hysteresis	max. 0.5 % from end value, max. 150 mV
Input	
Input voltage	2 × 0...30 V DC (IN 1, IN 2)
Input resistor	100 kOhm
Output	
Number	3 transistor outputs
Output current	max. 0.7 A per channel, switched positive, short-circuit protected
General data	
Temperature range	0...+50 °C
Mounting method	DIN-rail mountable (EN 60715)

Description	
Functional description	The DC- or AC-voltage comparator serves for evaluating analog voltages, generated by pressure, temperature or other sensors. The analog input values are compared to internal or external reference voltages to over or underflow. Outputs will be switched, dependent on defined limits. Features: – 2 separate measuring channels (no galvanic separation), (only by comparator service) -2 operating modes (comparator/window discriminator) – adjustable reference voltage (internal/external) per channel – adjustable output (inverted/not inverted) per channel, (only by comparator service) – compact design (12.4 mm) – higher switched current at output – output state display through LED – Easy configuration of the module via DIP switch

Dimension drawing

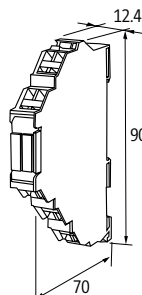
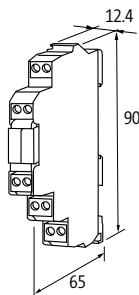

Murrelektronik Online Shop
onlineshop.murrelektronik.com/en

Notes

Temperature converter

– for PT 100 sensors

MTW 12.4

2-, 3-wire technology
Screw terminals



MTW 12.4

2-, 3-wire technology
Spring clamp terminals



Circuit diagram

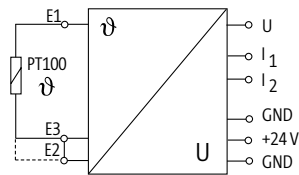

Order Data	Art-No.	Art-No.
INPUT: -50...+50 °C	44330	6644330
INPUT: -50...+150 °C	44331	6644331
INPUT: 0...100 °C	44332	6644332
INPUT: 0...200 °C	44334	6644334
INPUT: 0...600 °C	44336	6644336

Technical Data	
Operating voltage	24 V DC (18...30 V DC), smoothed
Operating current	max. 80 mA
Cable resistance (without PT100)	max. 100 Ohm (3-wire technology)
Output signals at 0...10 V DC	max. 25 mA, overload protected
Output signals at 4...20 V mA	max. 500 Ohm RL
Output signals at 0...20 mA	max. 500 Ohm RL
Tolerance	±1 % from end value
Temperature range	0...+60 °C

General data	
Mounting method	DIN-rail mountable (EN 60715)

Description	
Functional description	The Murrelektronik temperature converter module works in conjunction with a temperature sensor PT100 (IEC 751/EN 60751) and converts the temperature into a standard signal format of (0...10 V, 4...20 mA, 0...20 mA). The MTW modules supply a constant current to the PT100 resistor, which develops a variable voltage. This will be measured, linearized and converted to the output signal at the OUT terminals. All three signals can be used at the same time. The 2-wire technology allows short distances between the PT100 sensor and MTW module (< 5 m) to be covered. For longer distances the 3-wire technology has to be applied for compensating the cable resistance. This requires a 3rd cable (same length and type as the two measuring cables). The bridge between E2 and E3 has to be removed.

Dimension drawing

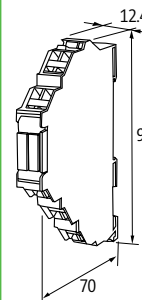
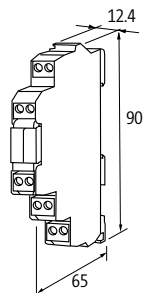

Murrelektronik Online Shop
onlineshop.murrelektronik.com/en

Notes

ACTIVE INTERFACE TECHNOLOGY

Switches

– unmanaged

– RJ45

Approvals:  Listed

Tree 6TX Eco

6 ports



Tree 8TX Metal

8 ports



Tree 6TX Metal

6 ports



Order Data	Art-No.	Art-No.	Art-No.
6 ports	58170		58172
8 ports		58171	
Connections			
Fieldbus	6 × RJ45	8 × RJ45	6 × RJ45
Supply System	Screw plug-in terminal: 0.2...1.5 mm ²		
Technical Data			
Operating voltage	2 × 9...30 V DC, redundancy	2 × 9...48 V DC, redundancy	2 × 9...30 V DC, redundancy
Transfer rate	10/100 MBit/s full duplex		
Operating modes	Autocrossing Autonegotiation		
Diagnostic			
Communication status	via LED		
Monitoring - no voltage	yes		
General data			
Protection	IP20	IP50	
Housing	Black plastic	Metal black	
Temperature range	0...+60 °C (storage temperature -10...+70 °C)	-10...+70 °C (storage temperature -40...+85 °C)	
Mounting method	DIN-rail mountable TH35 (EN 60715)		
Dimension drawing			

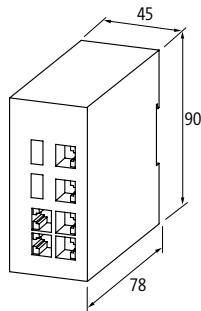

Brake rectifiers

Active controlled rectifier

Spring clamp terminals



Approvals: **us**

Circuit diagram

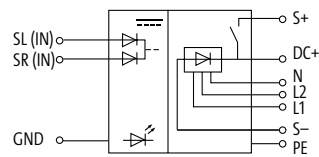

Order Data

24 V DC/0.8 A

Art-No.

50001

Input

Input voltage L1-N (230 V AC); L1-L2 (400 V AC); L1-L2 (480 V AC)

Input current max. 0.8 A

Control voltage 24 V DC

LED display LED (green)

Protection against reverse polarization yes

Output

Output voltage 205 V DC (230 V AC); 180 V DC (400 V AC); 215 V DC (480 V AC)

Output current max. 0.75 A

Switching frequency max. 2.5 Hz

General data

Temperature range 0...+55 °C (storage temperature -20...+60 °C), no condensation

Protection IP20

Mounting method DIN-rail mountable (EN 60715)

Connection Spring clamp terminals

Dimension drawing

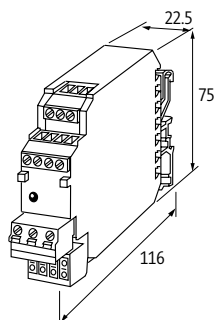

Murrelektronik Online Shop
onlineshop.murrelektronik.com/en

Notes

ACTIVE INTERFACE TECHNOLOGY

Demagnetizer

– with alarm contact

Demagnetizer

Screw terminals



Demagnetizer

Screw terminals

potential free alarm output 30 V AC/DC, 100 mA



Circuit diagram

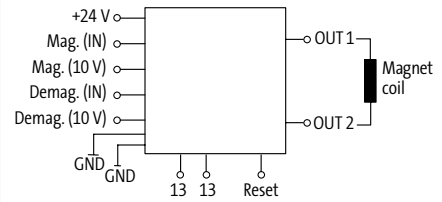
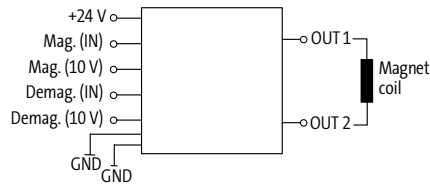

Order Data	Art-No.	Art-No.
24 V DC/40 mA	446140	446142

Technical Data		
Operating voltage	24 V DC (18...30 V DC)	
Operating current	approx. 40 mA	
LED display	LED (green)	
Protection against reverse polarization	yes	
Group alarm output	–	potential free alarm output 30 V AC/DC, 100 mA

Input		
Input resistor	approx. 10 kOhm	
Magnetization (digital)	safe OFF: max. 1V; safe ON: min. 5 V (LED yellow)	safe OFF: max. 1V; safe ON: min. 5 V (LED green)
Magnetization (analog)	0.8...8.8 V (0...100 %)	
Demagnetization (digital)	safe OFF: max. 1V; safe ON: min. 5 V (LED yellow)	
Demagnetization (analog)	0...10 V (44...55 %)	

Output		
Output voltage	24 V DC	
Output current	max. 1.5 A (short-circuit protected)	
PWM frequency	approx. 800 Hz	

General data		
Temperature range	-25...+50 °C (storage temperature -40...+80 °C)	
Protection	IP20	
Mounting method	DIN-rail mountable (EN 60715)	
Connection	Screw terminals	

Dimension drawing

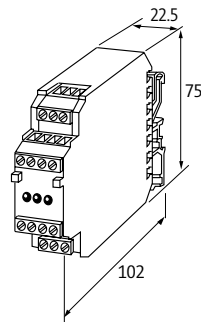

Murrelektronik Online Shop
onlineshop.murrelektronik.com/en

Notes

Remote and Signalling Systems

MIRO GSM



Approvals:  **UL** US
Listed

Circuit diagram

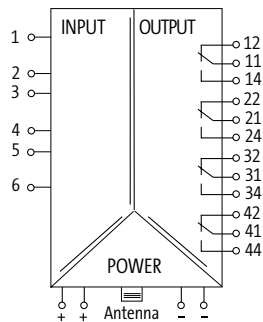

Order Data	Art-No.	Art-No.	Art-No.
DI6 DO4R - (Relay) 24 V DC	52530		
ADI6 DO4R (Relay) 24 V DC		52531	
DI6 DO4R - (Relay) 230 V AC			52532
Accessories			Art-No.
Stub antenna			52533
MIRO GSM Service Kit			52535
Input			
Connection voltage - current	12...48 V DC - 15 mA		110...240 V AC - 10 mA
Resolution (analog)	-	12 Bit	-
Input range (analog)	-	0...10 V DC	-
Input resistor (analog)	-	142 kOhm	-
Conversion time (analog)	-	max. 1 s	-
Output			
Switching voltage	max. 250 V AC/DC		
Switching current per output	max. 10 A		
Total current	max. 20 A		
Contact material	Ag Ni 90/10		
General data			
Mech./ elect. life	30.000.000 switching cycles/load dependent		
Protection	IP20		
Temperature range	-25...+55 °C (storage temperature -40...+85 °C)		
Connection	Screw terminals: max. 2.5 mm ² (AWG 14)		
Mounting method	DIN-rail mountable (EN 60715) or screw fixing		

Dimension drawing

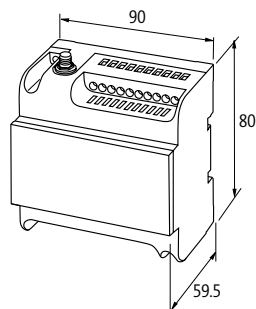





Murrelektronik Online Shop
onlineshop.murrelektronik.com/en

Notes

For inductive loads we recommend EMC suppressors connected parallel to the coil

ACTIVE INTERFACE TECHNOLOGY

Labeling accessories			Art-No.
	ACS label plate KM 5 for self marking (9 × 20 mm)		7000-99001-000000
	Label plate KM 4 5 × 10 mm		90931
	ACS label plate KM 6/18 for self marking with ADEMARK markers		7000-99003-000000
	Label plate KWI 5/15 (88 pieces per plate)		90901
Wiring accessories			Art-No.
	Potential plug link max. 50 V/2 A	MIRO	90961
	Potential rail blue 10-pole, spacing 6.2 mm	MIRO 6.2 (screw terminals)	90975
	Potential rail red 40-pole, spacing 12 mm 10-pole, spacing 6.2 mm	RMM..., RMMD... MIRO 6.2 (screw terminals)	90971 90976
	End caps for potential rail blue red	MIRO 6.2 RMM..., RMMD...	90980 90982
	Wire chain 16-pole Connection cable left and right approx. 50 cm; bk; 1 mm ²	MIRO (spring clamp terminals)	90977
	MIRO GSM Stub antenna		52533

Wiring accessories			Art-No.
	<p>MIRO GSM External antenna Connection cable 5m</p>		52534
	<p>MIRO GSM Service Kit Configuration CD USB/RS-232 converter Connection cable SUB-D9 (female/male)</p>		52535



PASSIVE INTERFACE TECHNOLOGY INTERFACE MODULES

- Screw or spring clamp terminals
- LED displays
- DIN rail mounting

FOR ANY APPLICATION

Murrelektronik's interface modules make the connections between the controls and the field. They take over 3 major functions in the system:

- Signal transfer from the machine to the control
- Signal transfer inside the machine or control system
- Easy wiring in control systems

Murrelektronik has been an innovative partner in coming up with interface solutions for years. Their interface modules are fitted with different kinds of robust plugs like SUB-D connectors or ribbon cable connectors for strong signal or power transfers.

They are extremely compact. Individual terminal labels and status displays are integrated into the standard modules.

Interface Modules



With ribbon cable connection
UFL

Page 1.13.1



With SUB-D connector
UG SUB, SV

Page 1.13.2



With pluggable terminals
LUGS, PKB

Page 1.13.5

PASSIVE INTERFACE TECHNOLOGY

Transfer modules

– Ribbon cable connection

UFL

Ribbon cable connector



UFL

Ribbon cable connector + LED

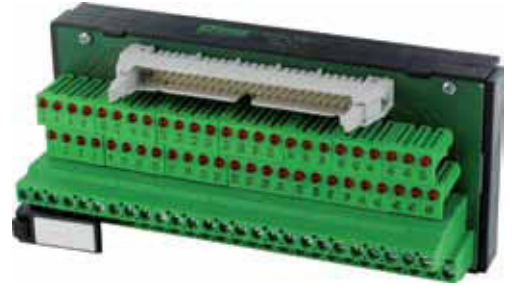

Circuit diagram

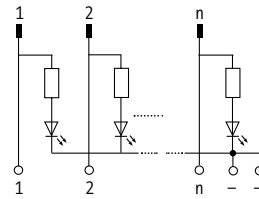
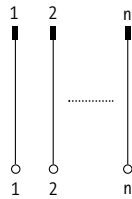

Order Data	H×W×D	Art-No.	H×W×D	Art-No.
10-pole	63×50×48 mm	54200	63×50×48 mm	54011
16-pole	63×50×48 mm	54201		
20-pole	63×50×48 mm	54202	63×75×48 mm	54013
26-pole	63×75×48 mm	54203	63×75×48 mm	54014
34-pole	63×95×48 mm	54204	63×95×48 mm	54015
40-pole	63×120×48 mm	54205	63×120×48 mm	54016
50-pole	63×140×48 mm	54206	63×140×48 mm	54017
64-pole	63×185×48 mm	54208	63×185×48 mm	54019

Technical Data

Operating voltage	max. 125 V AC/150 V DC	24 V AC
Operating current per bit	max. 1 A	
Air and creepage distances	(EN 60664-1) over voltage, category II	
LED display	–	LED (red) Ø 3 mm per pole, acc. to potential -
Temperature range	-20...+70 °C	
Plug connector	for plugs with or without strain relief (DIN 41651); for plugs with strain relief, it may be necessary to remove the bottom hook	

General data

Temperature range	-20...+70 °C
Mounting method	DIN-rail mountable (EN 60715)

Dimension drawing

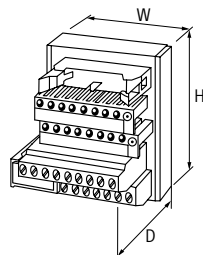

Murrelektronik Online Shop
onlineshop.murrelektronik.com/en

Notes

PASSIVE INTERFACE TECHNOLOGY

Transfer modules

– Plug connector SUB-D

UG-SUB

Male connector
Screw terminals



UG-SUB

Male connector
Spring clamp terminals



UG-SUB

Female connector
Screw terminals



UG-SUB

Female connector
Spring clamp terminals



Circuit diagram

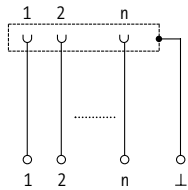

Order Data	HxWxD	Art-No.	HxWxD	Art-No.	HxWxD	Art-No.	HxWxD	Art-No.
9-pole	63×50×48 mm	54030	63×50×48 mm	6654030	63×50×48 mm	54040	63×50×48 mm	6654040
15-pole	63×75×48 mm	54031	63×75×48 mm	6654031	63×75×48 mm	54041	63×75×48 mm	6654041
25-pole	63×95×48 mm	54032	63×95×48 mm	6654032	63×95×48 mm	54042	63×95×48 mm	6654042
37-pole	63×75×58 mm	54033	63×75×58 mm	6654033	63×75×58 mm	54043	63×75×58 mm	6654043
50-pole	63×95×58 mm	54034			63×95×58 mm	54044		

Technical Data

Operating voltage	max. 125 V AC / 150 V DC
Operating current per bit	max. 2 A
Air and creepage distances	(EN 60664-1) over voltage, category II
Plug connector	Standard UNC 4-40 screw thread bolt (EN 60807)

General data

Temperature range	-20...+70 °C
Mounting method	DIN-rail mountable (EN 60715)

Dimension drawing

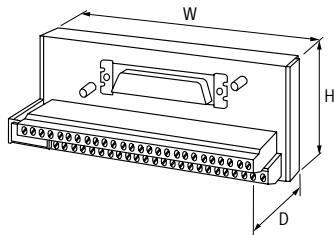

Notes

PASSIVE INTERFACE TECHNOLOGY

Transfer modules

– Plug connector SUB-D

UG-SUB

Male connector + LED
Screw terminals



UG-SUB

Female connector + LED
Screw terminals

Circuit diagram

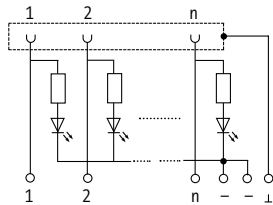

Order Data	H×W×D	Art-No.	H×W×D	Art-No.
9-pole	75×45×66 mm	54050	75×45×66 mm	54060
15-pole	75×70×66 mm	54051	75×70×66 mm	54061
25-pole	75×90×66 mm	54052	75×90×66 mm	54062
37-pole	75×135×66 mm	54053	75×135×66 mm	54063
50-pole	75×135×66 mm	54055	75×135×66 mm	54065

Technical Data

Operating voltage	24 V DC ±15 %
Operating current per bit	max. 2 A
LED display	LED (red) Ø 3 mm per pole, acc. to potential -
Air and creepage distances	(EN 60664-1) over voltage, category II
Temperature range	-20...+70 °C
Plug connector	Standard UNC 4-40 screw thread bolt (EN 60807)

General data

Mounting method: DIN-rail mountable (EN 60715)

Dimension drawing

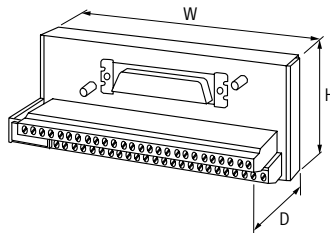

Murrelektronik Online Shop
onlineshop.murrelektronik.com/en

Notes

PASSIVE INTERFACE TECHNOLOGY

Transfer modules

– Signal transfer / 3-wire connection

– Plug connector SUB-D

SV-2 x SUB-D

2 ports
Female connector



SV-2 x SUB-D

2 ports
Male connector

Circuit diagram

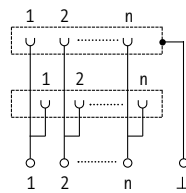

Picture: female

Order Data	HxWxD	Art-No.	HxWxD	Art-No.
15-pole	75x70x66 mm	54165		
25-pole	75x90x66 mm	54163	75x90x66 mm	54164
37-pole	86x90x78 mm	54161	86x90x78 mm	54162
50-pole			86x112.5x78 mm	54160

Technical Data

Operating voltage	max. 125 V AC / 150 V DC
Operating current per bit	max. 2 A
Air and creepage distances	(EN 60664-1) over voltage, category I
Temperature range	-20...+70 °C
Plug connector	Standard UNC 4-40 screw thread bolt (EN 60807)

General data

Mounting method	DIN-rail mountable (EN 60715)
-----------------	-------------------------------

Dimension drawing

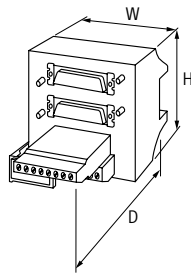

Murrelektronik Online Shop
onlineshop.murrelektronik.com/en

Notes

PASSIVE INTERFACE TECHNOLOGY

Transfer modules

– Screw plug-in terminals

LUGS

Screw plug-in terminals



PKB

Potential terminal block

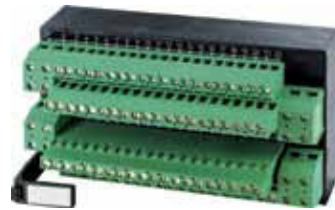

Circuit diagram

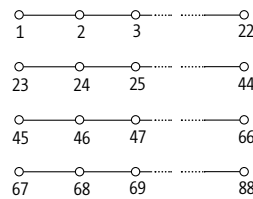
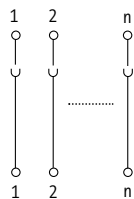

Order Data	H×W×D	Art-No.	H×W×D	Art-No.	H×W×D	Art-No.
2×8-pole	75×45×66 mm	54100				
4×8-pole	75×70×66 mm	54101				
4×12-pole	75×70×66 mm	54102				
4×16-pole	75×90×66 mm	54103				
4×22-pole			63×140×48 mm	54250	75×135×66 mm	54251

Technical Data

Operating voltage	max. 250 V AC	
Operating current per bit	max. 10 A	15 A per potential rail
Air and creepage distances	max. 10 A	(EN 60664-1) over voltage, category II
Total current	–	max. 100 A
Temperature range	-20...+60 °C	

General data

Connection	Screw plug-in terminal: max. 4 mm ² , single wire	Screw plug-in terminal: max. 4 mm ² , input terminal: max. 4 mm ² (single wire)
------------	--	---

Mounting method

DIN-rail mountable (EN 60715)

Dimension drawing

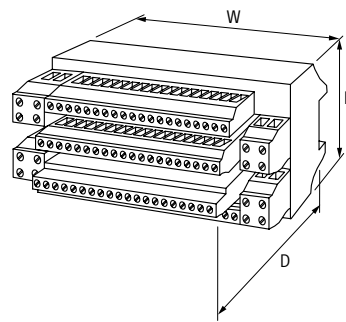
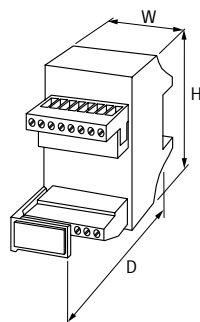

Notes

PASSIVE INTERFACE TECHNOLOGY

Transfer modules

– Spring clamp terminals

LUGS

pluggable Push-In spring clamp terminals



Circuit diagram

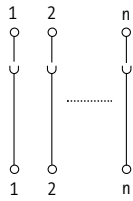

Order Data	HxWxD	Art-No.
4x8-pole	75x45x75 mm	6654101
4x12-pole	75x70x75 mm	6654102

Technical Data

Operating voltage	max. 250 V AC
Operating current per bit	max. 8 A
Air and creepage distances	(EN 50178) over voltage, category I
Temperature range	-20...+60 °C

General data

Connection	Spring clamp plug-in terminals: max. 2.5 mm ² (AWG 14)
Mounting method	DIN-rail mountable (EN 60715)

Dimension drawing

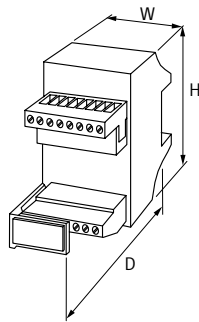

Murrelektronik Online Shop
onlineshop.murrelektronik.com/en

Notes

Accessories			Art-No.
	<p>ACS label plate KM 5 for self marking (9 × 20 mm)</p>		7000-99001-000000
	<p>ACS label plate KM 6/18 for self marking with ADEMARK markers</p>		7000-99003-000000
	<p>Standard UNC 4-40 screw thread bolt (EN 60807)</p>		54079
	<p>SUB-D snap-in connector 9...37-pole</p>		54077

EUROCARD HOLDERS / CONTROL MODULES

- Flexible applications
- Compact modules
- Connections with up to 96-poles

THE IDEAL CONTROL TECHNOLOGY FOR THE CABINET

Various electronic circuits are fitted onto 100 x 160 mm Eurocards and then placed in 19" system housings. Murrelektronik's Eurocard holders are designed to mount Eurocards on DIN rails in the cabinet.

In control systems, units are used which require analog control signals (i.e. 0...10 V DC). With these well designed MPOT potentiometer modules, it is simple, cheap and easy to solve your set-point problems. The diode modules of the MKS series are designed for decoupling and interference applications. The LED indicators are available with diameters of 3, 5, and 10 mm. With their compact design, they are suitable for installation in front panels or process flow diagrams.

Eurocard Holders



SKT

Page 1.14.1



SKP

Page 1.14.3

Control Modules



Potentiometer modules
MPOT

Page 1.14.9



Diode modules
MKS-D, MKS-LDP, MKS-BCD

Page 1.14.10



Assembly modules
MKS-M, ML 14, MP

Page 1.14.12

EUROCARD HOLDERS / CONTROL MODULES

Eurocard holders

– For Eurocards 100 × 160 mm

SKT

32-pole F (EN 60603)
Screw terminals



SKT

32-pole C (EN 60603)
Screw terminals

Circuit diagram

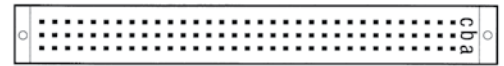

Order Data

	Art-No.	Art-No.
Configuration (Row b, z)	63510	
Configuration (Row d, z)	63518	
Configuration (Row a, c)		63516

Technical Data

Operating voltage	250 V AC	
Operating current	max. 4 A	max. 2 A
Configuration	32-pole F (EN 60603)	32-pole C (EN 60603)
Air and creepage distances	(EN 60664-1) over voltage, category I	
Material	Plastic, flame retardant	

General data

Connection	4 mm ² single core
Mounting method	DIN-rail mountable (EN 60715) in vertical or horizontal position or screw fixing

Description

Functional description
To insert the card first press down the 2 yellow buttons. Then slide the Eurocard into the guide slots pushing until fully engaged. The card is now locked into position. It can be removed by pressing down on the 2 yellow buttons.

Dimension drawing

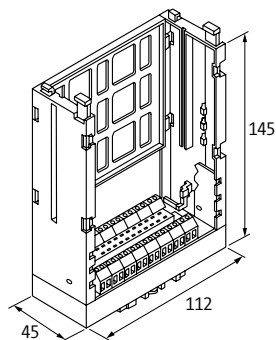

Murrelektronik Online Shop
onlineshop.murrelektronik.com/en

Notes

EUROCARD HOLDERS / CONTROL MODULES

Eurocard holders

– For Eurocards 100 × 160 mm

SKT

32-pole D (EN 60603)
Screw terminals



SKT

31-pole (DIN 41617)
Screw terminals

Circuit diagram

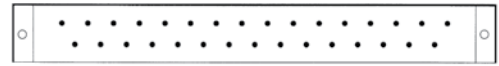
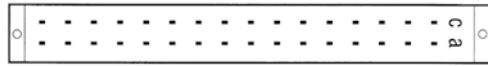

Order Data	Art-No.	Art-No.
Configuration (Row a, c)	63512	
Configuration (all)		63501

Technical Data

Operating voltage	250 V AC	
Operating current	max. 4 A	max. 5 A
Configuration	32-pole D (EN 60603)	31-pole (DIN 41617)
Air and creepage distances	(EN 60664-1) over voltage, category I	
Material	Plastic, flame retardant	

General data

Connection	4 mm ² single core
Mounting method	DIN-rail mountable (EN 60715) in vertical or horizontal position or screw fixing

Description

Functional description	To insert the card first press down the 2 yellow buttons. Then slide the Eurocard into the guide slots pushing until fully engaged. The card is now locked into position. It can be removed by pressing down on the 2 yellow buttons.
------------------------	---

Dimension drawing

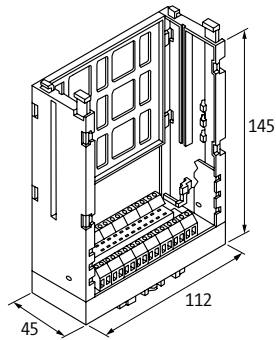

Murrelektronik Online Shop
onlineshop.murrelektronik.com/en

Notes

EUROCARD HOLDERS / CONTROL MODULES

Eurocard holders

– For Eurocards 100 × 160 mm

SKP

48-pole F (EN 60603)
Screw terminals



SKP

32-pole F (EN 60603)
Spring clamp terminals



Circuit diagram

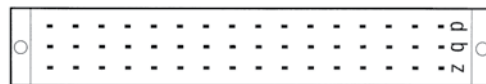

Order Data

Configuration (Row z, b, d)

Art-No.

63020

Art-No.

4000-63011-4304800

Configuration (Row b, z)

4000-63011-4253200

Accessories

Adapter

Art-No.

63900

Technical Data

Operating voltage

250 V AC

Operating current

max. 4 A

Configuration

48-pole F (EN 60603)

32-pole F (EN 60603)

Air and creepage distances

(EN 60664-1) over voltage, category I

Material

Plastic, flame retardant

General data

Connection

4 mm² single core

Mounting method

DIN-rail mountable (EN 60715) or screw fixing

Description

Functional description

To insert the card first press down the 2 yellow buttons. Then slide the Eurocard into the guide slots pushing until fully engaged. The card is now locked into position. It can be removed by pressing down on the 2 yellow buttons.

Dimension drawing

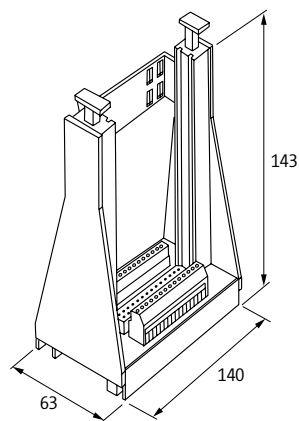

Murrelektronik Online Shop
onlineshop.murrelektronik.com/en

Notes

EUROCARD HOLDERS / CONTROL MODULES

Eurocard holders

– For Eurocards 100 × 160 mm

SKP

32-pole C (EN 60603)
Screw terminals

SKP

64-pole C (EN 60603)
Screw terminals

SKP

64-pole C (EN 60603)
Spring clamp terminals



Circuit diagram

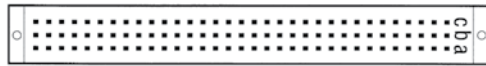

Order Data	Art-No.	Art-No.	Art-No.
Configuration (Row a, c)	631776	63043	4000-63011-1236400

Accessories	Art-No.
Adapter	63900

Technical Data	
Operating voltage	250 V AC
Operating current	max. 2 A
Configuration	32-pole C (EN 60603) 64-pole C (EN 60603)
Air and creepage distances	(EN 60664-1) over voltage, category I
Material	Plastic, flame retardant

General data	
Mounting method	DIN-rail mountable (EN 60715) or screw fixing
Connection	4 mm ² single core

Description	
Functional description	To insert the card first press down the 2 yellow buttons. Then slide the Eurocard into the guide slots pushing until fully engaged. The card is now locked into position. It can be removed by pressing down on the 2 yellow buttons.

Dimension drawing

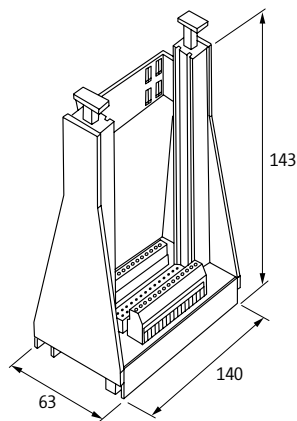

Murrelektronik Online Shop
onlineshop.murrelektronik.com/en

Notes

EUROCARD HOLDERS / CONTROL MODULES

Eurocard holders

– For Eurocards 100 × 160 mm

SKP

64-pole C (EN 60603)
Screw terminals
with LED



SKP

96-pole C (EN 60603)
Screw terminals

Circuit diagram



Order Data

Configuration (Row a, c)
Configuration (Row a, b, c)

Art-No.

631615

Art-No.

636013

Accessories

Adapter

Art-No.

63900

Technical Data

Operating voltage	24 V DC	125 V AC
Operating current	max. 2 A	max. 1 A
Configuration	64-pole C (EN 60603)	96-pole C (EN 60603)
Air and creepage distances	(EN 60664-1) over voltage, category II	(EN 60664-1) over voltage, category I
Material	Plastic, flame retardant	

General data

Connection: 4 mm² single core
Mounting method: DIN-rail mountable (EN 60715) or screw fixing

Description

Functional description

To insert the card first press down the 2 yellow buttons. Then slide the Eurocard into the guide slots pushing until fully engaged. The card is now locked into position. It can be removed by pressing down on the 2 yellow buttons.

Dimension drawing

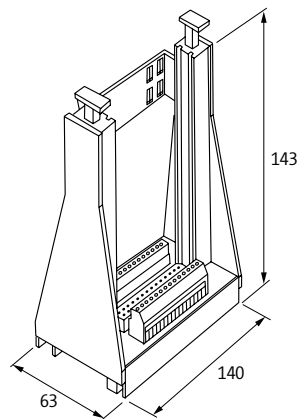

Murrelektronik Online Shop
onlineshop.murrelektronik.com/en

Notes

EUROCARD HOLDERS / CONTROL MODULES

Eurocard holders

– For Eurocards 100 × 160 mm

SKP

64-pole B (EN 60603)
Screw terminals



SKP

32-pole D (EN 60603)
Screw terminals

SKP

32-pole D (EN 60603)
Spring clamp terminals



Circuit diagram

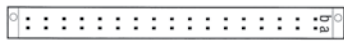

Order Data	Art-No.	Art-No.	Art-No.
------------	---------	---------	---------

Configuration (Row a, b)	63042		
--------------------------	-------	--	--

Configuration (Row a, c)		630732	4000-63011-2203200
--------------------------	--	--------	--------------------

Accessories	Art-No.
-------------	---------

Adapter	63900
---------	-------

Technical Data

Operating voltage	250 V AC	
-------------------	----------	--

Operating current	max. 2 A	max. 4 A
-------------------	----------	----------

Configuration	64-pole B (EN 60603)	32-pole D (EN 60603)
---------------	----------------------	----------------------

Air and creepage distances	(EN 60664-1) over voltage, category I	(EN 60664-1) over voltage, category II
----------------------------	---------------------------------------	--

Material	Plastic, flame retardant	
----------	--------------------------	--

General data

Connection	4 mm ² single core
------------	-------------------------------

Mounting method	DIN-rail mountable (EN 60715) or screw fixing
-----------------	---

Description

Functional description	To insert the card first press down the 2 yellow buttons. Then slide the Eurocard into the guide slots pushing until fully engaged. The card is now locked into position. It can be removed by pressing down on the 2 yellow buttons.
------------------------	---

Dimension drawing

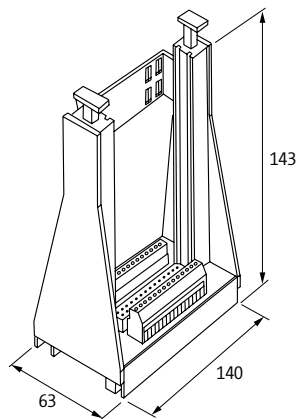

Murrelektronik Online Shop
onlineshop.murrelektronik.com/en

Notes

EUROCARD HOLDERS / CONTROL MODULES

Eurocard holders

– For Eurocards 100 × 160 mm

SKP

64-pole G (EN 60603)
Screw terminals



SKP

64-pole G (EN 60603)
Spring clamp terminals

SKP

24-, 7-pole M (EN 60603)
Screw terminals

SKP

24-, 7-pole M (EN 60603)
Spring clamp terminals



Circuit diagram

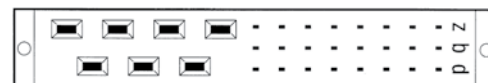
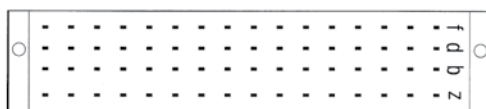

Order Data

	Art-No.	Art-No.	Art-No.	Art-No.
Configuration (Row z, b, d, f)	63040	4000-63011-5406400		
Configuration (Row z, b, d)			63048	4000-63011-6302470

Accessories

	Art-No.
Adapter	63900

Technical Data

Operating voltage	250 V AC	250 V AC (24-pole) / 500 V AC (7-pole)
Operating current	max. 3 A	max. 4 A (24-pole) / 15 A (7-pole)
Configuration	64-pole G (EN 60603)	24-, 7-pole M (EN 60603)
Air and creepage distances	(EN 60664-1) over voltage, category I	
Material	Plastic, flame retardant	

General data

Connection	4 mm ² single core
Mounting method	DIN-rail mountable (EN 60715) or screw fixing

Description

Functional description
To insert the card first press down the 2 yellow buttons. Then slide the Eurocard into the guide slots pushing until fully engaged. The card is now locked into position. It can be removed by pressing down on the 2 yellow buttons.

Dimension drawing

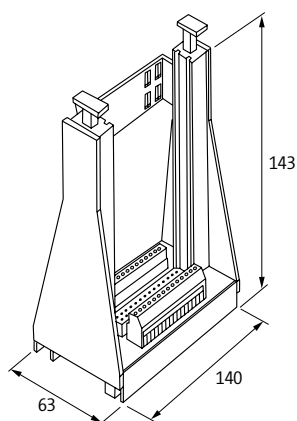

Murrelektronik Online Shop
onlineshop.murrelektronik.com/en

Notes

EUROCARD HOLDERS / CONTROL MODULES

Eurocard holders

– For Eurocards 100 × 160 mm

SKP 31 / I

31-pole (DIN 41617)
Screw terminals

SKP 31 / II

31-pole (DIN 41617)
Screw terminals

SKP 31 / II

31-pole (DIN 41617)
Spring clamp terminals



Circuit diagram

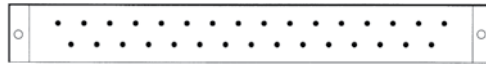

Order Data	Art-No.	Art-No.	Art-No.
Configuration (all)	63001	63007	4000-63011-9203100

Accessories	Art-No.
Adapter	63900

Technical Data	
Operating voltage	250 V AC
Operating current	max. 5 A
Configuration	31-pole (DIN 41617)
Air and creepage distances	(EN 60664-1) over voltage, category I
Material	Plastic, flame retardant

General data	
Connection	4 mm ² single core
Mounting method	DIN-rail mountable (EN 60715) or screw fixing

Description	
Functional description	To insert the card first press down the 2 yellow buttons. Then slide the Eurocard into the guide slots pushing until fully engaged. The card is now locked into position. It can be removed by pressing down on the 2 yellow buttons.

Dimension drawing

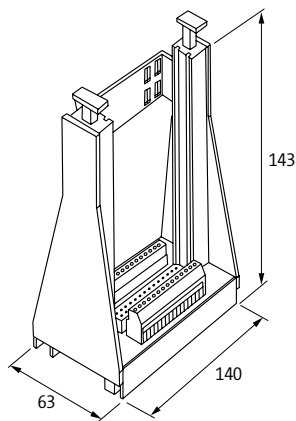

Murrelektronik Online Shop
onlineshop.murrelektronik.com/en

Notes

Potentiometer modules

MPOT

270° potentiometer with relay contact



MPOT

10-turn potentiometer with relay contact



MPOT

270° potentiometer



MPOT

10-turn potentiometer



Circuit diagram

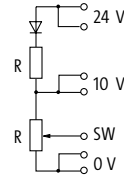
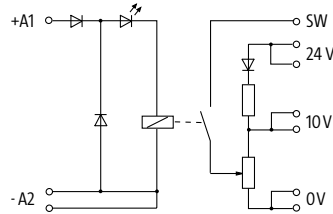

Order Data	Art-No.	Art-No.	Art-No.	Art-No.
1 kOhm	67551	67561	67501	67511
5 kOhm	67555	67565	67505	67515
10 kOhm	67552	67562	67502	67512
100 kOhm	67553		67503	67513

Technical Data

Resistance tolerance	±20 %	±5 %	±20 %	±5 %
Linearity	±3 %	±0.25 %	±3 %	±0.25 %
Power: potentiometer	1 W	1.4 W (2 W at 40 °C)	1 W	1.4 W (2 W at 40 °C)
Power: resistor	0.25 W			

Input

Input voltage	24 V DC	–		
Input current	20 mA	–		
LED display	LED (green)	–		

Output

Switching voltage	10 V DC or 24 V DC	–		
Switching current per output	1 mA/1 A	–		
Contact material	PdNi-Au Rh	–		

General data

Temperature range	0...+60 °C			
Mounting method	DIN-rail mountable (EN 60715)			

Dimension drawing

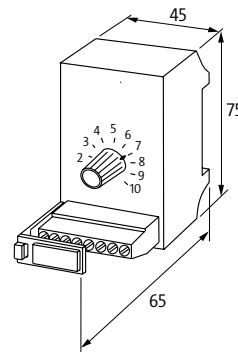
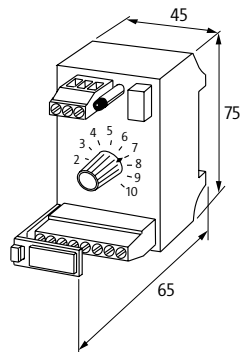

Murrelektronik Online Shop
onlineshop.murrelektronik.com/en

Notes

EUROCARD HOLDERS / CONTROL MODULES

Diode modules

MKS-D

separation contact via pluggable jumpers

MKS-D

Diodes with common potential



Circuit diagram

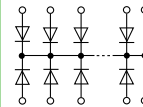
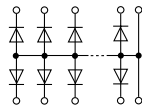
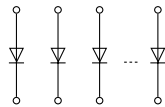

Order Data	Art-No.	Art-No.	Art-No.
Single potential (6 diodes)	67063		
Com. potential anode (10 diodes)		67040	
Com. potential cathode (10 diodes)			67045

Technical Data

Operating voltage max. 48 V AC/DC

General data

Temperature range -20...+60 °C

Connection Screw terminals: max. 4 mm²

Mounting method DIN-rail mountable TH35 or G32 (EN 60715)

Description

Functional description Diode modules are suitable for the suppression of inductive loads (valve, contactor, etc.)

Dimension drawing

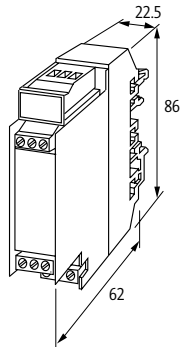

Notes

Diode modules

MKS-D

separation contact via pluggable jumpers

MKS-D

Diodes with common potential



Circuit diagram

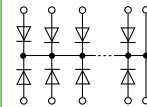
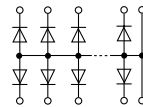
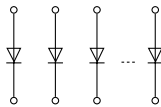

Order Data

	Art-No.	Art-No.	Art-No.
Single potential (10 diodes)	67066		
Com. potential anode (20 diodes)		67052	
Com. potential cathode (20 diodes)			67057

Technical Data

Operating voltage max. 48 V AC/DC

General data

Temperature range -20...+60 °C

Connection Screw terminals: max. 4 mm²

Mounting method DIN-rail mountable TH35 or G32 (EN 60715)

Description

Functional description Diode modules are suitable for the suppression of inductive loads (valve, contactor, etc.)

Dimension drawing

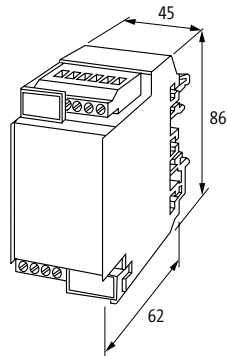

Murrelektronik Online Shop
onlineshop.murrelektronik.com/en

Notes

EUROCARD HOLDERS / CONTROL MODULES

Assembly modules

MKS-M

screw terminals connected to solder pin pairs



MKS-M

screw terminals connected to solder pin pairs



ML 14

with breadboard



MP

screw terminals connected to solder pin pairs



Circuit diagram

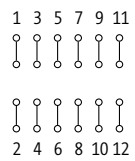
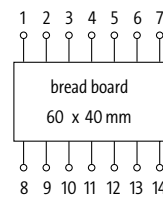
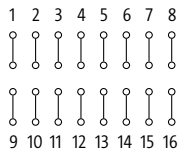
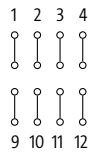

Order Data	HxWxD	Art-No.	HxWxD	Art-No.	HxWxD	Art-No.	HxWxD	Art-No.
Pairs of solder pins 4/30 mm		67081						
Pairs of solder pins 8/40 mm				67083				
Pairs of solder pins 14						92200		
Pairs of solder pins 6/24 mm							63x45x36 mm	62001
Pairs of solder pins 6/50 mm							90x63x36 mm	62030
Pairs of solder pins 12/24 mm							63x70x36 mm	62010
Pairs of solder pins 16/24 mm							63x90x36 mm	62020

Technical Data

Operating voltage	max. 250 V AC/DC		
Operating current	max. 2.5 A	max. 5 A	

General data

Temperature range	-20...+60 °C		
Mounting method	DIN-rail mountable TH35 or G32 (EN 60715)		DIN-rail mountable TH35 or G32 (EN 60715) or screwable

Connection	Screw terminals: max. 4 mm ² , pairs of solder pins (spacing 5 mm)		
Housing	Plastic, flame retardant. Cover removable	Plastic, flame retardant. Housing closed, side part removable.	Plastic, flame retardant. Open design.

Dimension drawing

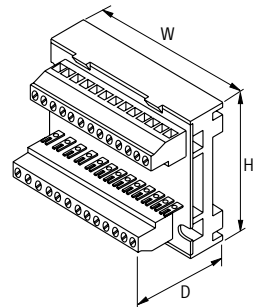
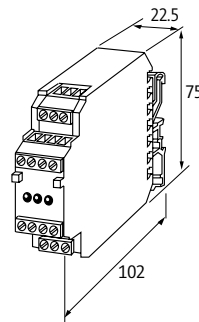
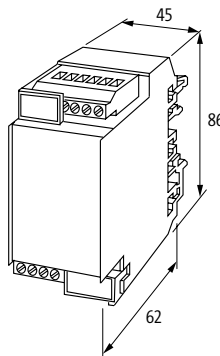
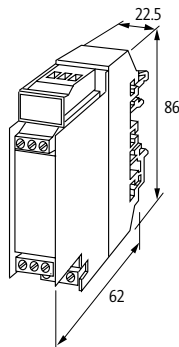

Notes

Murrelektronik Online Shop
onlineshop.murrelektronik.com/en

EUROCARD HOLDERS / CONTROL MODULES

Accessories			Art-No.
	<p>ACS label plate KM 5 for self marking (9 × 20 mm) for self marking with ADEMARK markers</p>		<p>7000-99001-0000000 7000-99003-0000000</p>