

Air-Operated Double-Diaphragm

High Purity PTFE Pumps



TOGGLE INDEX

yamada

www.yamadapump.com

The Yamada Advantage

When it comes to quality, performance and reliability, there's no better value in high-purity pumps than Yamada. We've been helping companies solve their liquid transfer problems since 1905 and have over four decades of experience in the design and manufacture of air-operated, double-diaphragm pumps.

Every Yamada pump is manufactured to the strictest quality standards and fully tested prior to shipment. In addition, each pump is backed by the local service and parts you need to keep them operating efficiently for years to come. Visit our Website for details on Yamada's complete line of AODD pumps.



Industry flows through **YAMADA** pumps.

Quality, Performance, Reliability

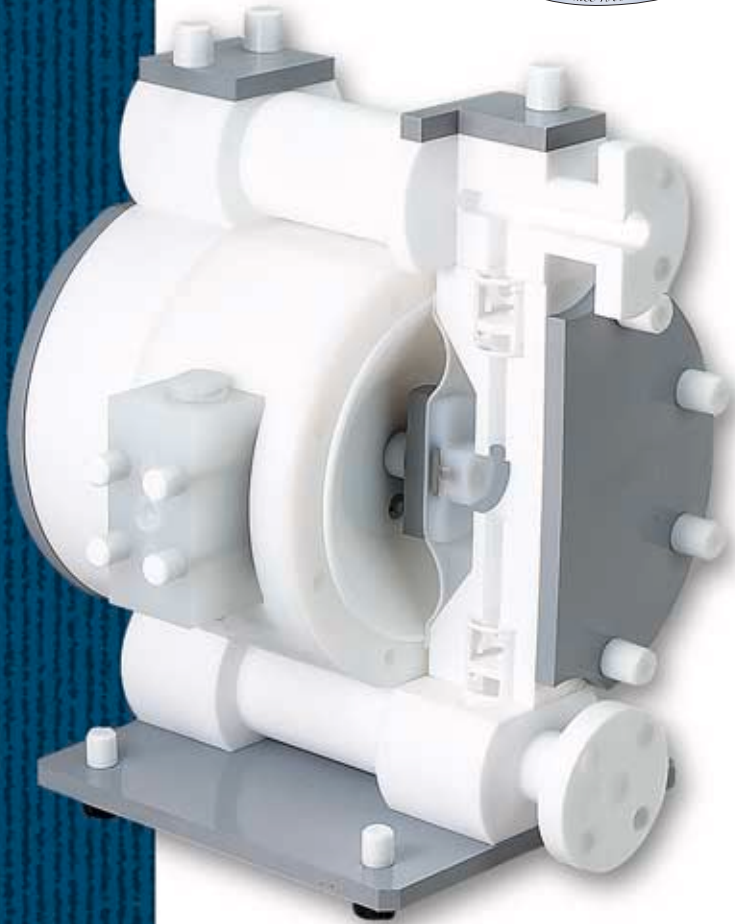
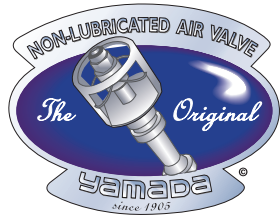

Important features you'll find in Yamada F-Series PTFE pumps:

Truly Non-Lubricated Air Valve

The patented air valve on all Yamada F-Series pumps never requires lubrication or pre-packing. Plus, it is easily accessible without disassembling the pump.

Wetted Parts

To ensure maximum corrosion resistance, purity levels and low particle generation, Yamada pumps feature diaphragms, liquid chambers and manifolds that are machined from 100% virgin PTFE. Polypropylene and High Density Polyethylene are used in the air motor section (non-wetted) to ensure resistance in a corrosive environment.

Extended Performance Diaphragms

All Yamada F-Series diaphragms are manufactured from 100% virgin PTFE. As a result, these diaphragms will last up to twice as long as those found in many competitive pumps. In addition, incorporating minimal shaft travel reduces pump pulsation.

Clean Room Manufactured

Yamada F-Series pumps are manufactured, DI water tested, nitrogen purged, and double bagged under class 1000 clean room conditions according to stringent quality control standards and procedures.

Most Complete Line Available

Yamada offers five sizes of F-Series pumps for your applications with adjustable flow rates up to a maximum of 35 gallons per minute. Yamada is proud to offer the largest line of field-proven, high purity air-operated double diaphragm pumps.

End-User Maintenance

Yamada F-Series pumps are easily end-user maintainable and are backed with readily available service and parts worldwide.

Explosion-Proof Operation

Air operation eliminates a potential source of ignition, so there's no need to take additional preventative measures when pumping volatile or flammable liquids or when using the pump in potentially hazardous environments.

Warranty

Yamada warrants all pumps for one year from date of installation.

Contents

DP-5F Series Pumps	2
DP-10F Series Pumps	3
DP-20F Series Pumps	4
DP-25F Series Pumps	5
DP-38F Series Pumps	6
Pulsation Dampeners	7
C-Series Pumps	8
EP-Series Pumps	8
F-Series Pumps Specifications	9

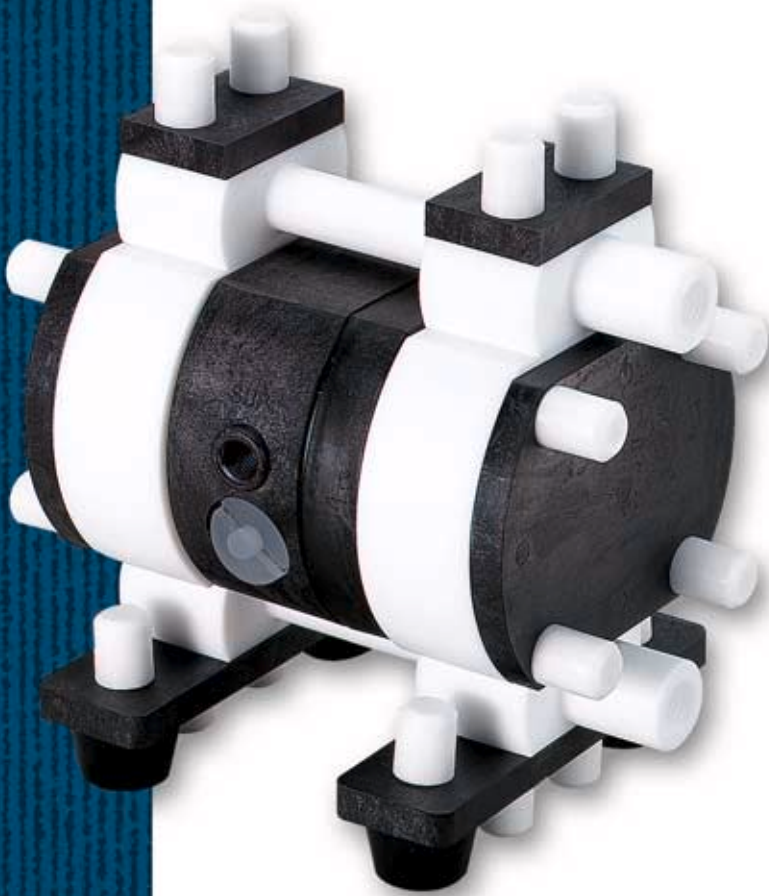

DP-5F Pumps

- 1/4" NPT or 3/8" Flaretek® liquid connections.
- Maximum flow up to 3.25 gallons/minute.
- Internal silencer.
- End-user maintainable.
- Self-priming.
- Field-proven design.
- Clean room manufactured, DI water tested, nitrogen purged, and double bagged.
- Flat check valves standard.
- Detailed specifications inside back cover.

Performance Curve

Data based on 1-ft. flooded suction

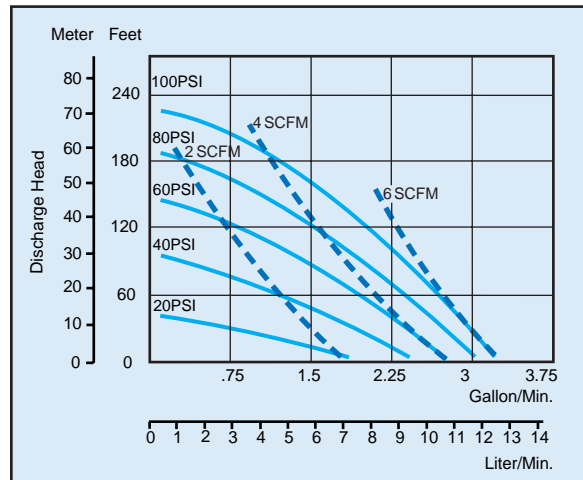

Flaretek® is a trademark of Fluoroware, Inc.

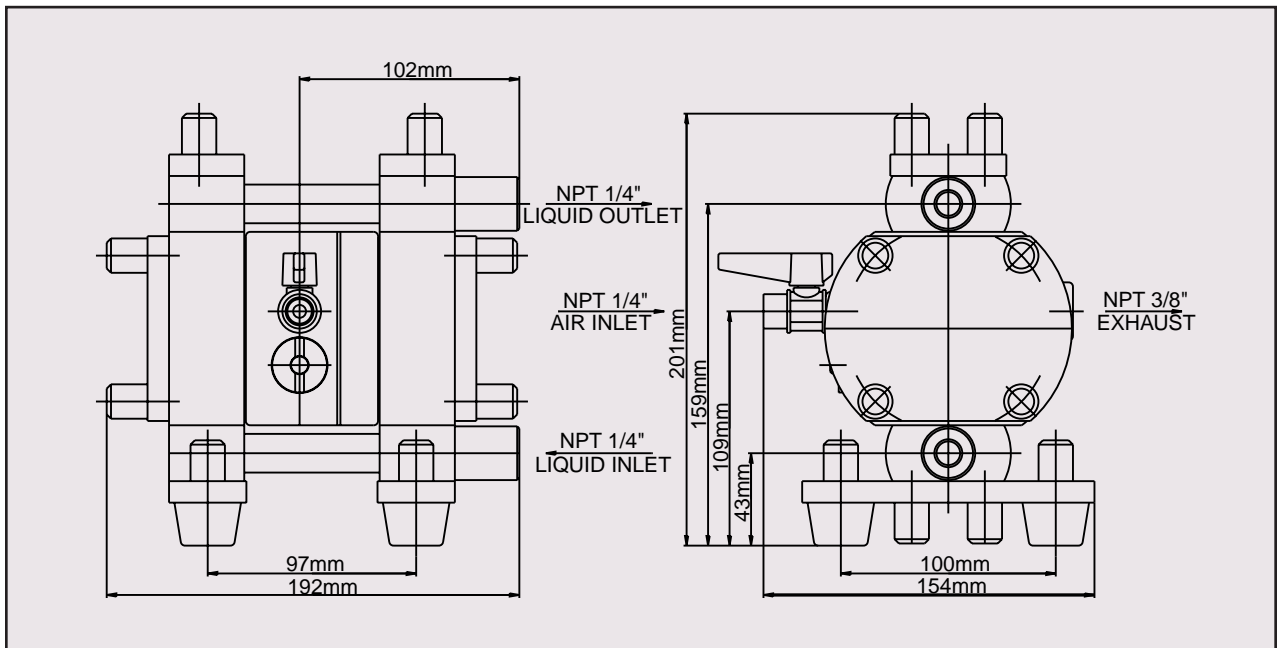

NPT version CAD shown above. [Flaretek version available at www.yamadapump.com](http://www.yamadapump.com) or contact Yamada.

DP-10F Pumps

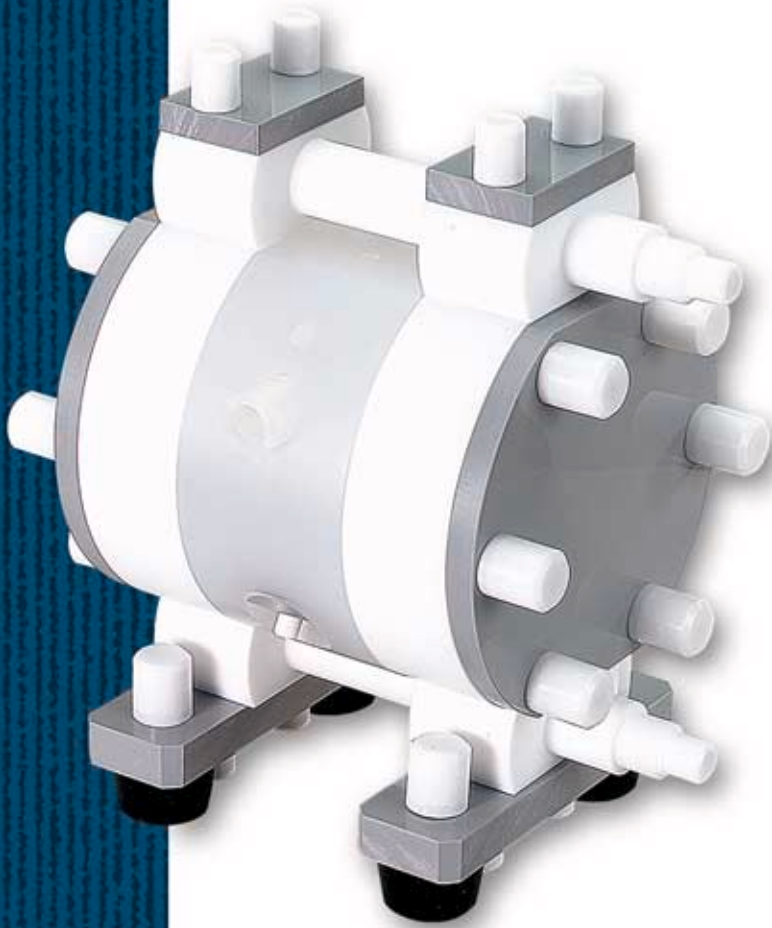

- Available with 3/8" NPT, 1/2" Flaretek, or 1/2" ANSI flange liquid connections.
- Maximum flow up to 6.0 gallons/minute.
- End-user maintainable.
- Self-priming.
- Field-proven design.
- Clean room manufactured, DI water tested, nitrogen purged, and double bagged.
- Ball or flat check valves available.
- Detailed specifications inside back cover.

Performance Curve

Data based on 1-ft. flooded suction, ball-type check valve.

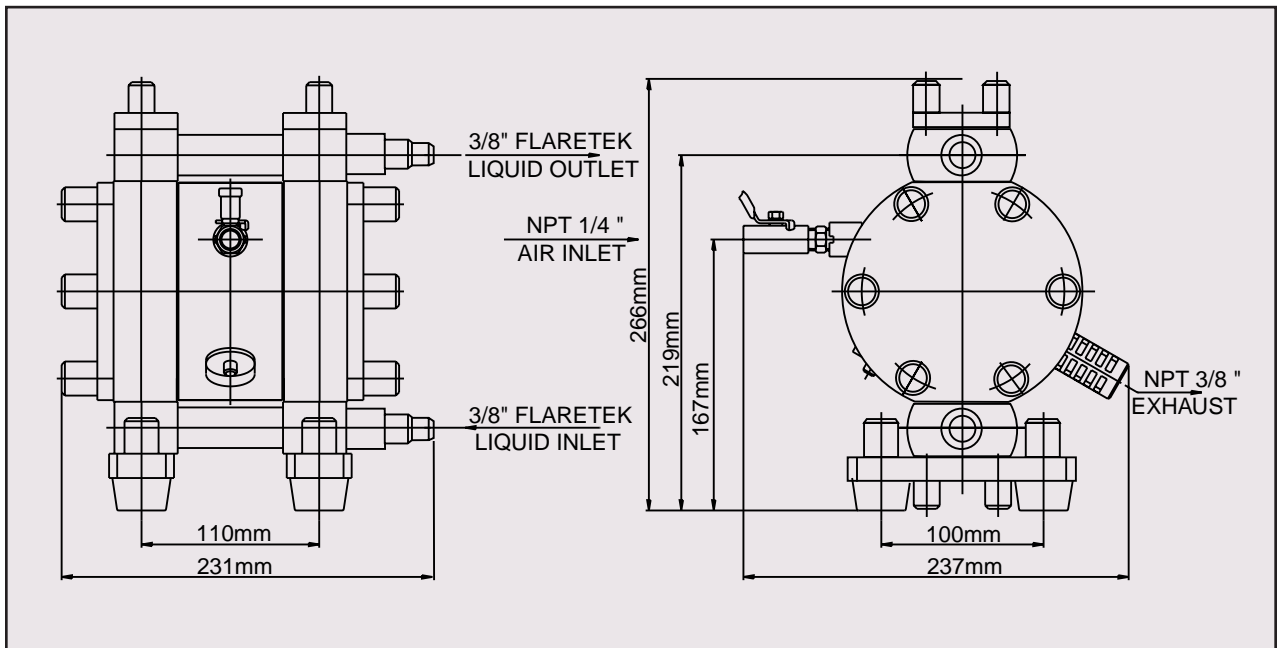
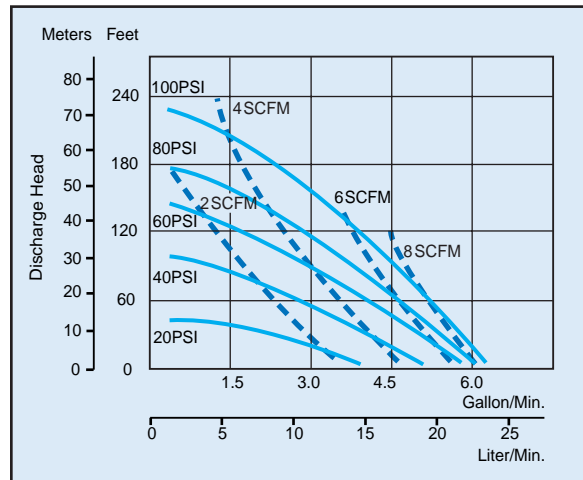

Flaretek version CAD shown above. [NPT and ANSI flange versions available at www.yamadapump.com](http://www.yamadapump.com) or contact Yamada.

DP-20F Pumps

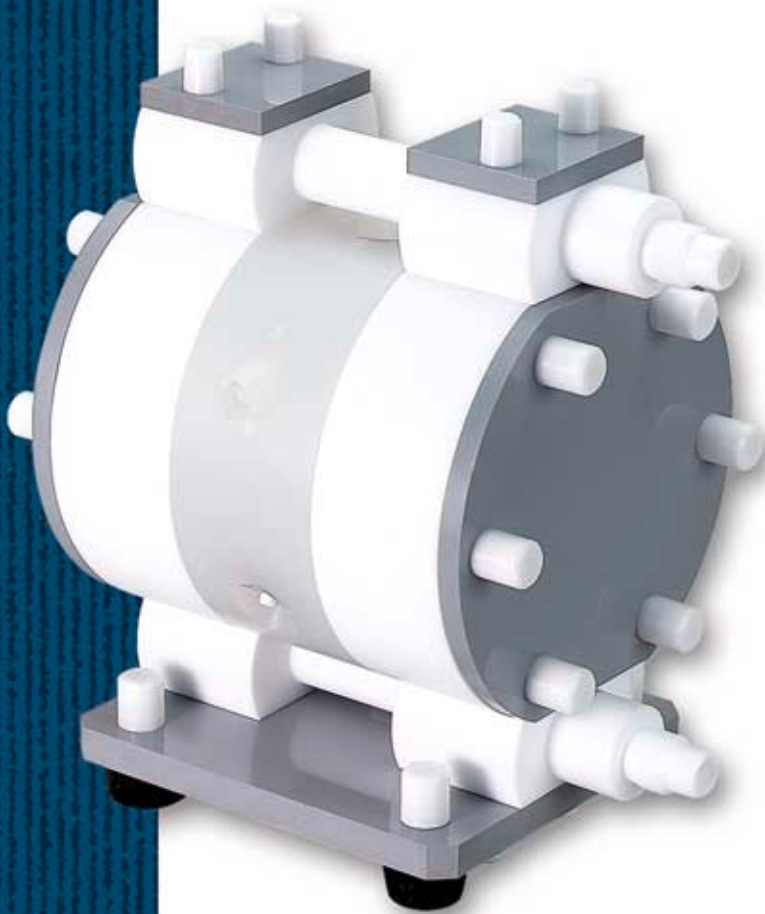

- Available with 3/4" Flaretek, 3/4" ANSI flange or 3/4" NPT liquid connections.
- Maximum flow up to 15.0 gallons/minute.
- End-user maintainable.
- Self-priming.
- Field-proven design.
- Clean room manufactured, DI water tested, nitrogen purged, and double bagged.
- Ball or flat check valves available.
- Detailed specifications inside back cover.

Performance Curve

Data based on 1-ft. flooded suction, ball-type check valve

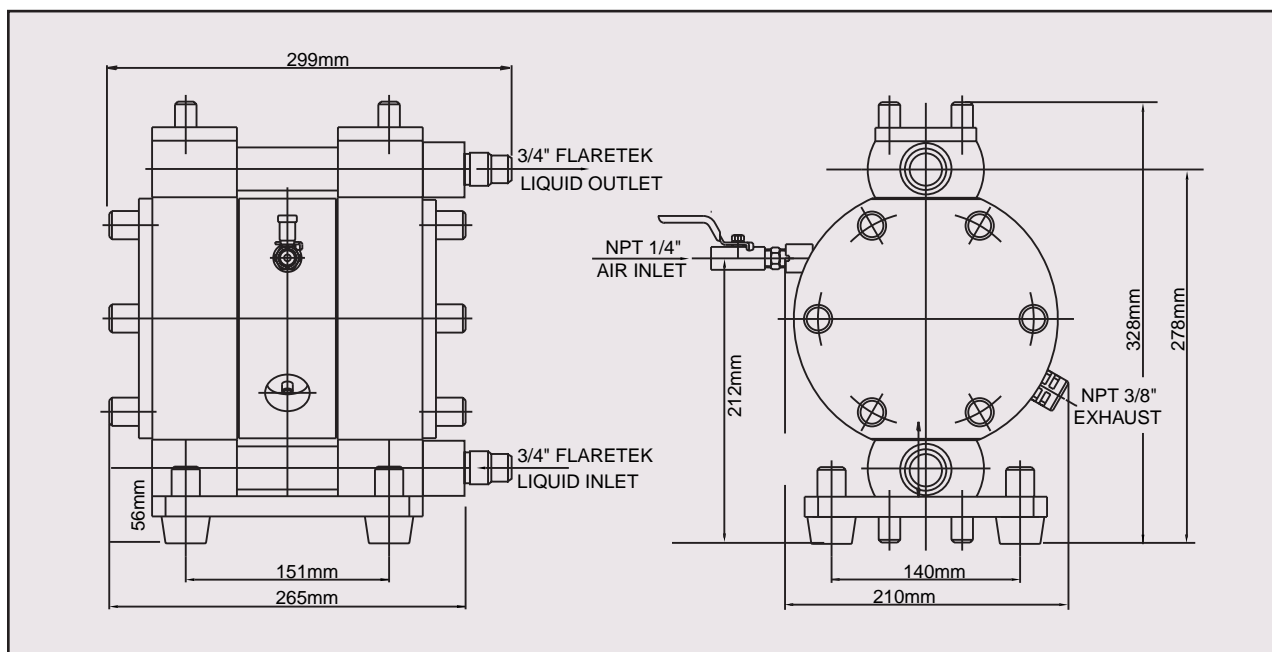
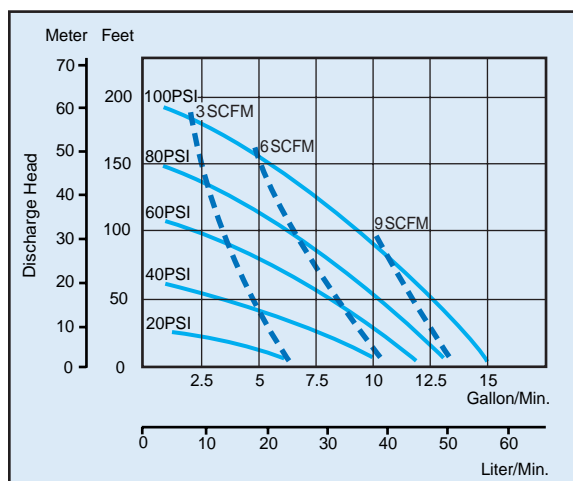

Flaretek version CAD shown above. [NPT and ANSI flange versions available at www.yamadapump.com](http://www.yamadapump.com) or contact Yamada.

DP-25F Pumps

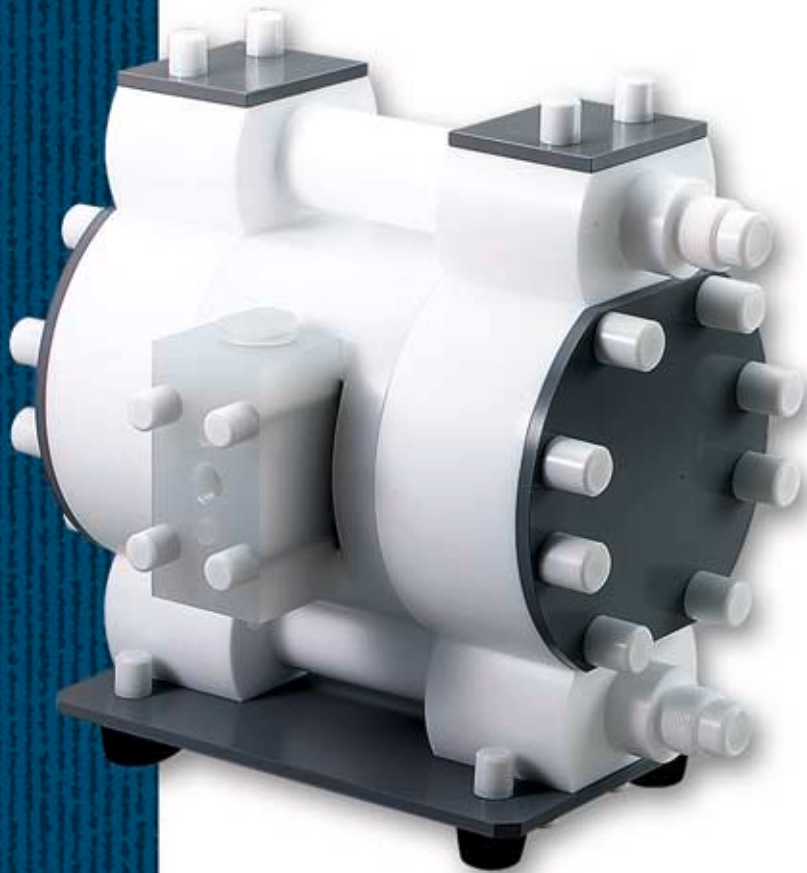

- Available with 1" Flaretek or 1" ANSI flange liquid connections.
- Maximum flow up to 28.0 gallons/minute.
- End-user maintainable.
- Self-priming.
- Field-proven design.
- Clean room manufactured, DI water tested, nitrogen purged, and double bagged.
- Ball or flat check valves available.
- Detailed specifications inside back cover.

Performance Curve

Data based on 1-ft. flooded suction, ball-type check valve

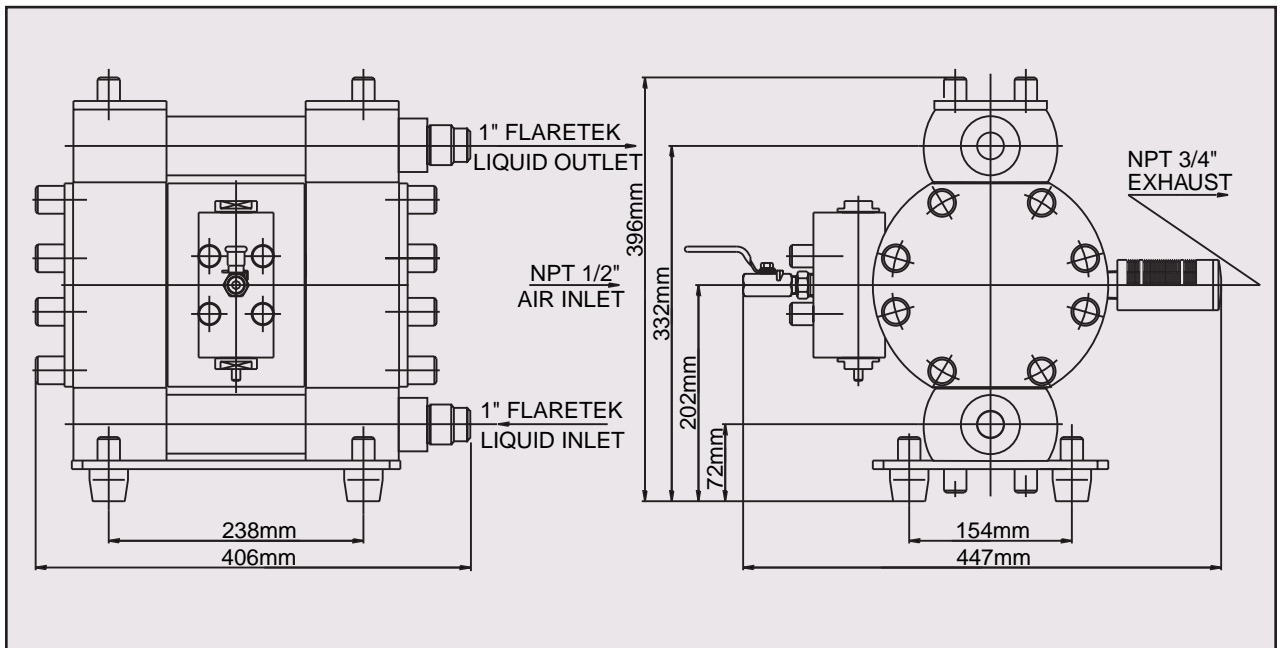
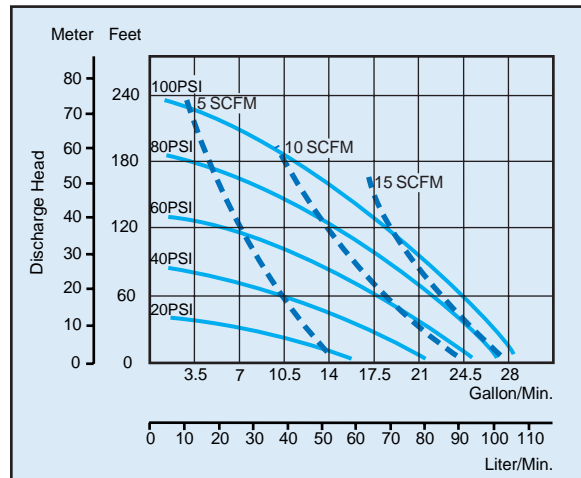

Flaretek version CAD shown above. [ANSI flange version available at www.yamadapump.com](http://www.yamadapump.com) or contact Yamada.

DP-38F Pumps



- Available with 1" Flaretek or 1" ANSI flange liquid connections.
- Maximum flow up to 35.0 gallons/minute.
- End-user maintainable.
- Self-priming.
- Field-proven design.
- Clean room manufactured, DI water tested, nitrogen purged, and double bagged.
- Ball or flat check valves available.
- Detailed specifications inside back cover.

Performance Curve

Data based on 1-ft. flooded suction, ball-type check valve

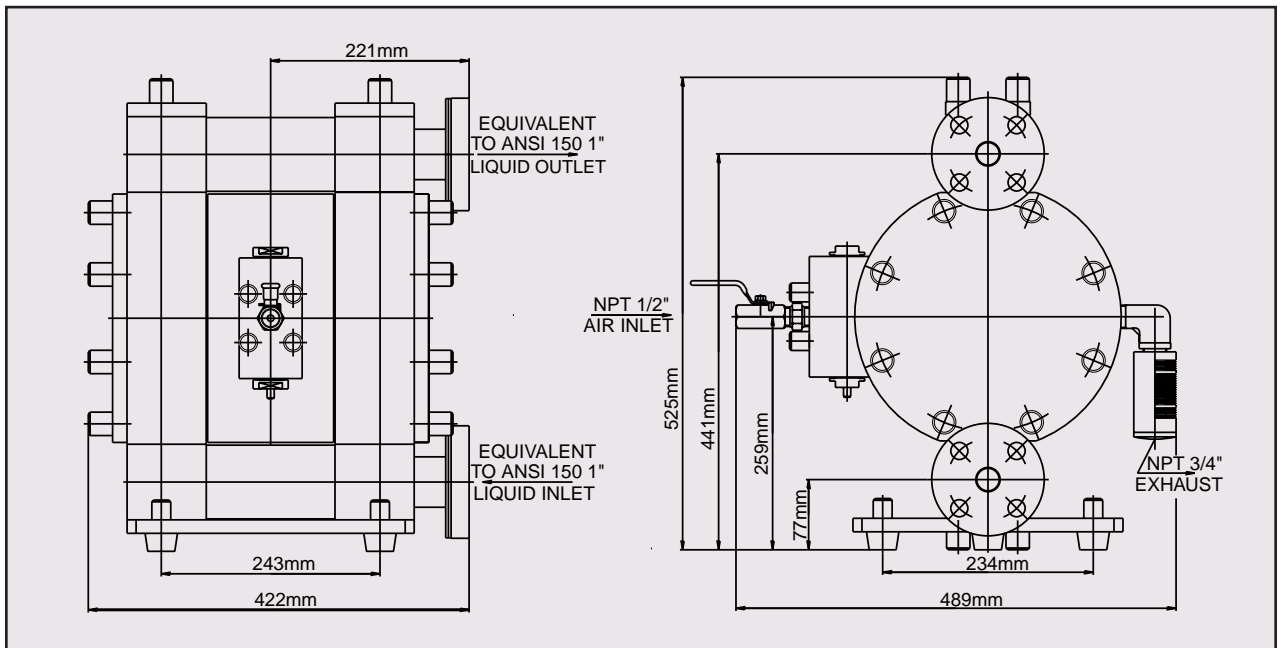
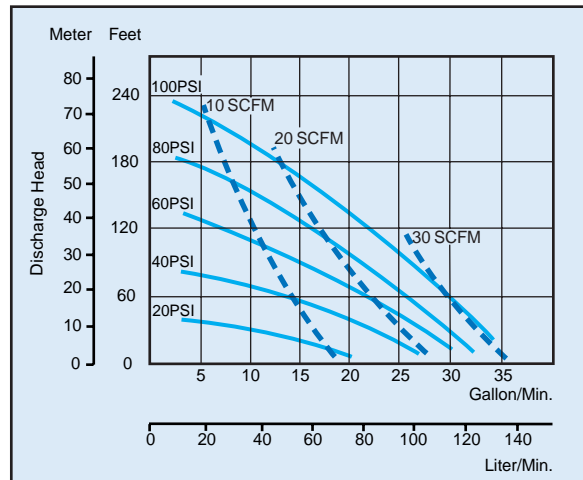

Pulsation Dampeners

- For all F-Series PTFE pumps.
- 100% PTFE wetted construction.
- Reduces pulsations up to 90%.
- Easy-to-install.
- Explosion-proof, air-operated design.
- Completely automatic.

Performance Data

Pump Cycles

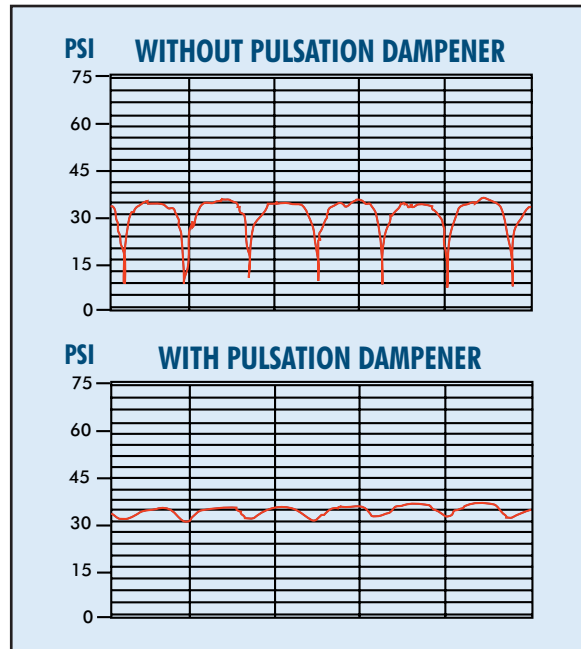

Pulsation Dampeners are designed to reduce pulsations normally associated with air-operated double-diaphragm pumps, protecting the entire pump system from the damaging effects of shock. Yamada offers a complete line of high-purity pulsation dampeners for a variety of applications.

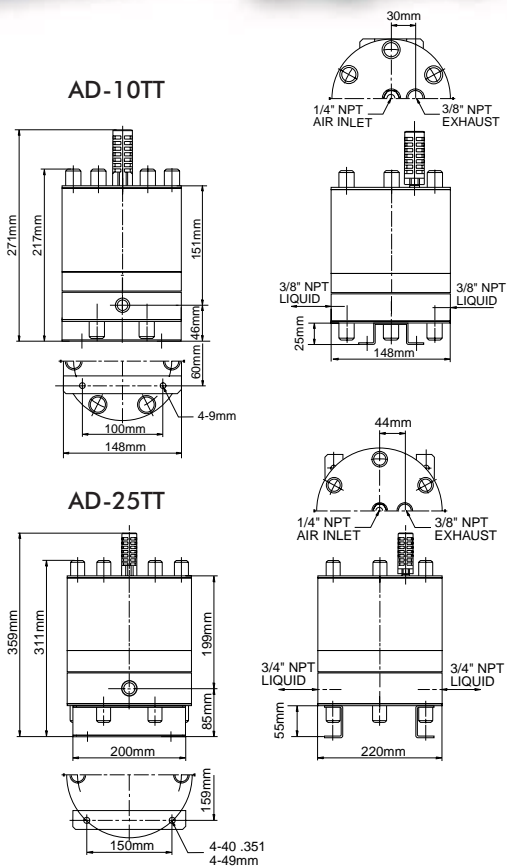
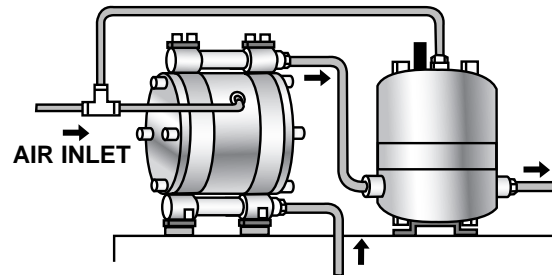

Model Number	For Pump Models	Air Inlet	Liquid Inlet & Discharge	Weight
AD-10TT	DP-5F and DP-10F	1/4" NPT	3/8" NPT or 1/2" Flaretek	8.8 lbs. (4.0 kg)
AD-25TT	DP-20F and DP-25F	1/4" NPT	3/4" NPT or 1" Flaretek	26.5 lbs. (12.0 kg)
AD-38TT	DP-38F	1/4" NPT	1" NPT or 1" Flaretek	84.0 lbs. (38.0 kg)

C-Series Pumps



- Transfer pumps for non-high purity applications in a corrosive environment.
- No exposed metal.
- Polypropylene and PVDF housings and PTFE elastomers.
- Available in 1/4" and 1/2" liquid connections.
- Maximum flow up to 15.0 gallons/minute.
- Self-priming.
- Field-proven design.
- Never needs air line lubrication.
- Additional sizes and materials are available. Please contact Yamada or visit our Website.
- For expanded technical information, please refer to the Yamada General Brochure.

EP-Series Pumps

- Transfer pumps for high-purity solvents and other liquids compatible with stainless steel.
- 316 stainless steel housings and PTFE elastomers.
- Electro polished up to 420#.
- Available in 1/4", 1/2", 3/4" and 1" NPT liquid connections. Optional Swagelok®, VCR®, Sanitary Clamp, Tube or ANSI flange liquid connections.
- Maximum flow up to 35 gallons/minute.
- Never needs air line lubrication.
- Field-proven design.
- Electro polished pulsation dampeners are also available.
- Additional sizes and materials are available. Please contact Yamada or visit our Website.
- For expanded technical information, please refer to the Yamada General Brochure.

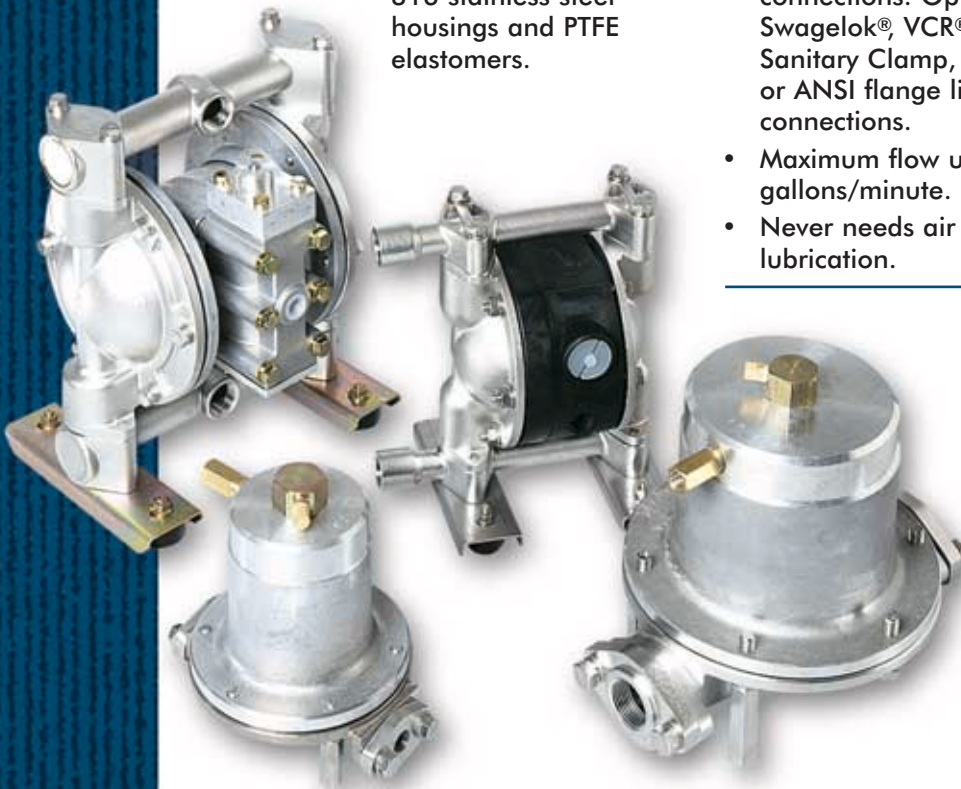

Optional Swagelok®, VCR®, Sanitary Clamp, Tube or ANSI flange liquid connections.

Swagelok® and VCR® are trademarks of the Swagelok Companies.

F-Series Pumps Specifications

Model	DP-5F	DP-10F	DP-20F	DP-25F	DP-38F
Pump Material					
Casing Manifold Body (Non-Wetted)	PTFE PTFE Ryton (PPS resin)	PTFE PTFE Polypropylene	PTFE PTFE Polypropylene	PTFE PTFE Polypropylene	PTFE PTFE High Density Polyethylene
Check Valve	Flat	Ball or flat check valves available. Flat check valve is recommended for increased flow (up to 5%) and suction lift applications. Ball check valve is recommended for flooded suction or viscous liquids.			
Discharge Volume/Cycle	0.005 gal. (13 cc)	0.017 gal. (65 cc)	0.04 gal. (150 cc)	0.105 gal. (400 cc)	0.185 gal. (700 cc)
Maximum Cycles/Minute	400	250	250	230	150
Port Dimensions					
Liquid Inlet & Discharge	3/8" Flaretek or 1/4" NPT	1/2" Flaretek 1/2" ANSI flange 150# or 3/8" NPT	3/4" Flaretek 3/4" ANSI flange 150# or 3/4" NPT	1" Flaretek or 1" ANSI flange 150#	1" Flaretek or 1" ANSI flange 150#
Air Inlet	Female 1/4" NPT	Female 1/4" NPT	Female 1/4" NPT	Female 3/8" NPT	Female 1/2" NPT
Air Exhaust (with muffler)	Female 3/8" NPT	Female 3/8" NPT	Female 3/8" NPT	Female 3/4" NPT	Female 3/4" NPT
Air Supply Pressure	20 to 100 PSI (1.4 to 7 kgf/cm ²)	20 to 100 PSI (1.4 to 7 kgf/cm ²)	20 to 100 PSI (1.4 to 7 kgf/cm ²)	20 to 100 PSI (1.4 to 7 kgf/cm ²)	20 to 100 PSI (1.4 to 7 kgf/cm ²)
Maximum Liquid Temperature*	176° F (80° C) *212° F (100° C)	176° F (80° C) option available, consult Yamada	176° F (80° C)	212° F (100° C)	212° F (100° C)
Net Weight	Flaretek/NPT 7.5 lbs. (3.4 kg)	Flaretek/NPT 14.7 lbs. (6.7 kg) Flange 15.9 lbs. (7.2 kg)	Flaretek/NPT 32.2 lbs. (14.6 kg) Flange 34.2 lbs. (15.5 kg)	Flaretek 86.2 lbs. (39.2 kg) Flange 88.2 lbs. (40.0 kg)	Flaretek 111.6 lbs. (50.6 kg) Flange 114.6 lbs. (52.0 kg)

Due to Yamada's commitment to continual product improvement, specifications subject to change without notice.

Utility Pumps

In addition to high purity pumps, Yamada offers a full line of industrial air-operated double-diaphragm pumps. Contact Yamada for our full-line general brochure.

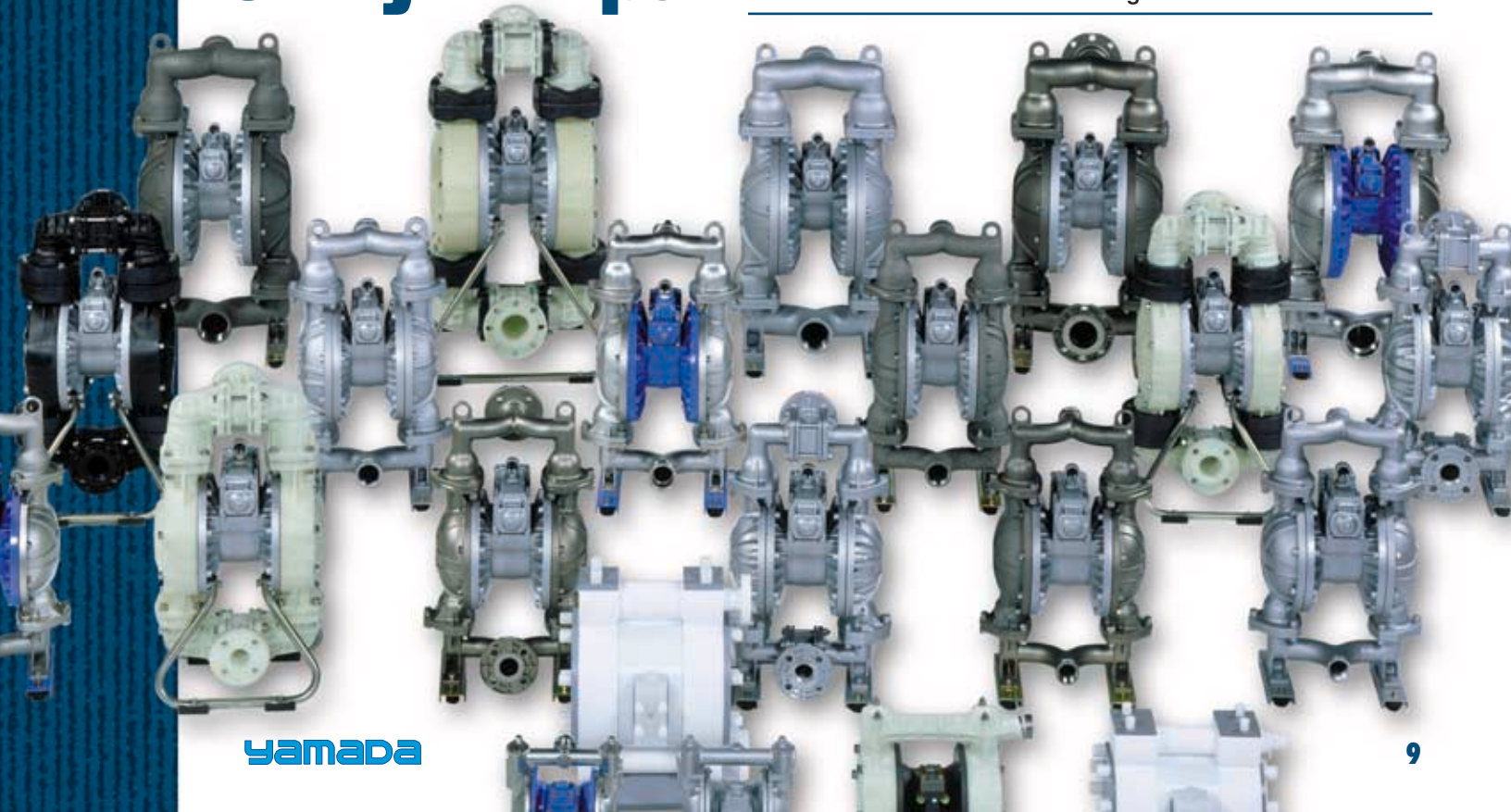

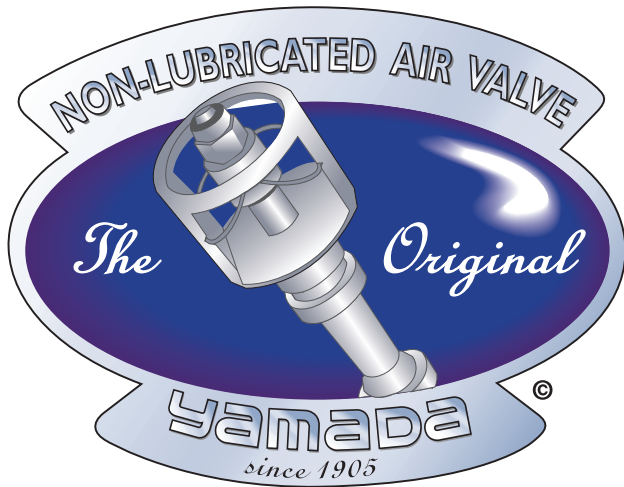

Industry flows through
Yamada pumps.



Yamada America, Inc.
955 E. Algonquin Road
Arlington Heights, IL 60005
Phone: 847.631.9200
Fax: 847.631.9273
Toll free: 1.800.990.7867
E-mail: sales@yamadapump.com



Yamada Corporation
International Department
No. 1-3, 1-Chrome, Minami Magome, Ohta-Ku
Tokyo, 143-8504 Japan
Phone: Tokyo 81-(0)3 3777-0241
Fax: Tokyo 81-(0)3 3777-0584
E-mail: intl@yamadacorp.co.jp



Yamada Europe
Aquamarijnstraat 50
7554 NS Hengelo
The Netherlands
Phone: 31(0)74 2422032
Fax: 31(0)74 2421055
E-mail: company@yamada.nl

Yamada

www.yamadapump.com