Bulletin 1606 Switched Mode Power Supplies

Page 8-2



Bulletin 1497 Control Transformers

Page 8-13



Power Supplies

Product Overview/Quick Guide/Cat. No. Explanation



Bulletin 1606 — Power Supplies†

- Quick mounting and connecting, innovative DIN-Rail mount, smallest in class
- Low inrush current limiting
- PFC choke
- Wide range input; auto select input
- Superior overload design (continuous current, no hiccup)
- NEC Class 2 'Limited Power' option
- Selectable operating mode (single/parallel)
- Superior efficiency and temperature rating

Special Modules

- Brownout buffer, DC to DC converter, N+1 redundancy

Standards Compliance

- World-wide Certifications‡
- NEC Class 2
- FM Class 1 Div. 2 (T3A)

Table of Contents

Quick Guide this page
 Cat. No. Explanation this page
 Product Selection ... 8-3
 Accessories 8-3
 Specifications 8-4
 Special Modules 8-8
 Approximate Dimensions 8-9
 1606-XL Redundancy Capabilities 8-11
 1606-XL Buffer 8-12

Certifications



* Not all features apply to all power supplies; see individual power supply descriptions for specifics

† A more detailed list of performance specifications can be found at the Allen-Bradley web site http://www.ab.com/industrialcontrols/products/power_supplies/index.html

‡ Dual UL rating with cURus 60950 relating to certified use in information technology.

Quick Guide

Bulletin 1606-(number from table)§ Power Supply Quick Guide

	30...40 W	50 W	60 W	72 W	100 W	120 W	180 W	240 W	480 W	720 W	960 W
5...5.5V	XLP25A	—	—	—	—	—	—	—	—	—	—
10...12V	XLP30B	—	—	—	—	—	—	—	—	—	—
12...15V	—	XLP50B	—	—	XLP90B	—	XL180B	—	—	—	—
(+/-)12 and 15V	XLP36C	—	—	—	—	—	—	—	—	—	—
24...28V 1-Ph	XLP30E	XLP50E XLP50EZ	XL60D	XLP72E	XLP100E	XL120D	—	XL240E XL240EP	XL480E XL480EP XL480EPT	—	—
24...28V 3-Ph	—	—	—	—	—	XL120E-3	—	XL240E-3	XL480E-3 XL480E-3W XL480F-3H	XL720E-3	XL960E-3 XL960E-3S
36...43V	—	—	—	—	—	—	—	—	XL480GP	—	—
48...56V	—	XLP50F	—	—	XLP100F	—	—	XL240FP	XL480F	—	—
24V Redundant	—	—	XL60DR	—	—	XL120DR	—	XL240DR XLPRED	XLRED20-30		XLRED40
	—	—	—	—	XLDNET4	—	—	XLDNET8	—	—	—

§ Example: For a 24...28 Volt, 3-Phase, 120 Watt power supply, the Catalog Number would be 1606-XL120E-3.

Power Supply Cat. No. Explanation

Important: The following cat. no. breakdown is for explanation purposes only. It is not a product configurator. Not all combinations of fields are valid product cat. nos. First, select the desired power supply using the product selection table on page 8-3. Then, use this breakdown for verification and explanation only.

1606 – XL 240 E P -3
a b c d e

Power Supply Type	
Code	Description
XLP	Compact family
XL	Standard family

Rated Output Watts	
Code	Description
25	25 W
30	30 W
40	40 W
50	50 W
60	60 W
72	72 W
100	100 W
120	120 W
240	240 W
480	480 W
720	720 W
960	960 W

Output Voltage	
Code	Description
A	5V DC
B	12V DC or 12 to 15 V DC
C	Dual +/- 12 and 15V DC
D	24V DC
E	24...28V DC
F	48...56V DC
G	36...43V DC

Special Functions	
Code	Description
R	Redundancy module
P	Power factor correction
S	Special output signals
L	Load sharing
T	Remote shutdown
Z	Removeable Terminations
Can be left blank	

3-Phase Variations	
Code	Description
-3	Three phase
-3H	Three phase, input voltage 400V AC and 450...700V DC
-3W	Three phase, wide input range
-3S	Three phase, special output signals

Bulletin 1606 Product Selection Table





	Output Power	Output Voltage	Output Current	Special Features	Parallel Operation (inclined Characteristics)	Meets EN 61000-3-2 (PFC Harmonics)	Cat. No.
Compact Single Phase	25 W	5...5.5V DC	5.0 A	NEC Class 2	—	N/A	1606-XLP25A
	30 W	10...12V DC	3.0 A	NEC Class 2	—	N/A	1606-XLP30B
		24...28V DC	1.3 A	NEC Class 2	—	N/A	1606-XLP30E
	36 W	+/- 12/15V DC	4.2 A	Output voltage adjustable NEC Class 2	—	N/A	1606-XLP36C
	50 W	12...15V DC	4.2 A		—	N/A	1606-XLP50B
		24...28V DC	2.1 A	NEC Class 2	—	N/A	1606-XLP50E
		24...28V DC	2.1 A	NEC Class 2	—	N/A	1606-XLP50EZ
		48...56V DC	1.0 A	NEC Class 2	—	N/A	1606-XLP50F
	72 W	24...28V DC	3.0 A	NEC Class 2	—	N/A	1606-XLP72E
	90 W	12...15V DC	8 A	NEC Class 2	Yes	Yes	1606-XLP90B
100 W	24...28V DC	4.2 A		Yes‡	Yes	1606-XLP100E	
	48...56V DC	2.1 A		Yes‡	Yes	1606-XLP100F	
Standard Single Phase	60 W	24V DC	2.5 A	NEC Class 2	—	N/A	1606-XL60D
	120 W		—	—	Yes	1606-XL120D	
	180 W	12...15V DC	15 A	—	—	No	1606-XL180B
	240 W	24...28V DC	10 A	FM Class 1 Div. 2 T3A	—	No	1606-XL240E
		48...56V DC	5.0 A	—	—	Yes	1606-XL240EP
	480 W	24...28V DC	20 A	Active inrush current limiting	Yes‡	No	1606-XL480E
				—	Yes‡	Yes	1606-XL480EP
		36...43V DC	13 A	Remote shut down	Yes‡	Yes	1606-XL480EPT
				—	Yes‡	Yes	1606-XL480GP
	48...56V DC	10 A	—	Yes‡	No	1606-XL480F	
Standard Three Phase	120 W	24...28V DC	5.0 A	—	—	Yes	1606-XL120E-3
	240 W		10 A	Overload behavior selectable (FUSE Mode/continuous current), 2-phase operation admissible	Yes‡	Yes	1606-XL240E-3
			20 A	—	Yes‡	Yes	1606-XL480E-3
	480 W	20 A	Wide input range; overload behavior selectable (FUSE Mode/continuous current)	Yes‡	Yes	1606-XL480E-3W	
		48...56V DC	10 A	Input voltage 400V AC	Yes‡	Yes	1606-XL480F-3H
	720 W	24...28V DC	30 A	—	Yes‡	Yes	1606-XL720E-3
	960 W		40 A	Passive load sharing	Yes‡	Yes	1606-XL960E-3
			40 A	Active inrush current limiting; output signals	Active current sharing	Yes	1606-XL960E-3S
1606-XL Special Modules							
Special Modules	480 W	23...27.8V DC	20 A	Brownout buffer module	—	N/A	1606-XLBUFFER
	40 W	5.1V DC	8 A	DC/DC converter	—	No	1606-XLDC40A
	120 W	24V DC	4.0 A	Electronically limited 4 A	—	Yes	1606-XLDNET4
	240 W	24V DC	8 A	Electronically limited 8 A	—	No	1606-XLDNET8
	60 W	24...28V DC	2.5 A	N+1 Redundant capable , NEC Class 2*	Yes‡	N/A	1606-XL60DR
	120 W		5.0 A		Yes‡	Yes	1606-XL120DR
	240 W		10 A		Yes‡	No	1606-XL240DR
	720 W	V _{in} -.5V typ	30 A	Dual N+1 redundancy†	—	N/A	1606-XLRED20-30
	960 W	V _{in} -.6V typ	40 A	Single N+1 redundancy§	—	N/A	1606-XLRED40
	V _{in} 1 - .9 V (typ)	10...60V DC	10 A	Compact Redundancy 10-60 V DC	—	N/A	1606-XLPRED





Accessories

Accessory	Output Power	Output Voltage	Special Features	Parallel Operation	Meets EN 61000-3-2	Cat. No.
	—	—	Back of panel bracket for XL	—	—	1606-XLA

- * Used with a pair of identical power supplies to offer N+1 redundancy
- † To be used alongside 20, 30 and 40 A power supplies
- ‡ Single/parallel operation (inclined characteristic) selectable (jumper)
- § To be used alongside 40 A power supplies (or smaller)

1606-XLP Compact Single Phase Specifications

					
	1606-XLP25A	1606-XLP30B	1606-XLP30E	1606-XLP36C	1606-XLP50B
Watts	5...5.5V/25 W	10...12V/30 W	24...28V/30 W	±12V/±15V 36 W	12...15V/50 W
Input Voltage†	AC 100...240V wide range DC 85...370V	AC 100...240V wide range DC 85...375V		AC 100...240V wide range DC 85...375V	AC 100...240V wide range DC 85...375V
Operational Range	85...264 V AC				
Hold-up Time	>170 ms (AC 230V) >19 ms (AC 100V)	>170 ms (AC 230V) >18 ms (AC 100V)	>190 ms (AC 230V) >19 ms (AC 100V)	>180 ms (AC 230V) >18 ms (AC 100V)	>170 ms (AC 230V) >17 ms (AC 100V)
Rated Input Current	<0.5 A (AC 100V) <0.35 A (AC 196V)	<0.6 A (AC 100V) <0.25 A (AC 240V)	<0.6 A (AC 100V) <0.35 A (AC 196V)	<0.7 A (AC 100V) <0.4 A (AC 196V)	<1.0 A (AC 100V) <0.6 A (AC 196V)
Efficiency	>80% (AC 230V)	typ. 84% (AC 230V)	typ. 87.5% (AC 230V)	86% (AC 230V)	typ. 90% (AC 230V)
Output Voltage	5...5.5V 5.1V preset	10...12V 12V preset (with jumper), 10...12V adjustable (without jumper)	24...28V 24.5V preset	±12V (without jumper), ±15V (with jumper) ±15V preset	12...15V 15V preset (with jumper) 12...15V adjustable (without jumper)
Rated Output Current	5 A (at 5.1V), 4.5 A (at 5.5V)	3 A (at 10V), 2.5 A (at 12V)	1.3 A (at 24.5V), 1 A (at 28V)	0...2.8 A (+12V), 0...1.4 A (-12V), 0...2.4 A (+15V), 0...1.4 A (-15V)	4.2 A (at 12V), 3.4 A (at 15V)
Ripple/Noise	<50 mV _{pp} (20 MHz)	<2 mV _{pp} (200 kHz) <10 mV _{pp} (20 MHz)	<50 mV _{pp} (20 MHz)	<50 mV _{pp} (20 MHz)	<100mV _{pp} (20MHz)
Operating Temperature Range (T_{amb})	-10...+70 °C >60 °C: 0.5 W/K derating	-10...+70 °C >60 °C: 0.6 W/K derating	-10...+70 °C >60 °C: 0.5 W/K derating	-10...+70 °C > 60 °C: 1 W/K derating	-10...+70 °C >60 °C: 1 W/K derating
MTBF‡	600 000 hours	appr. 650 000 hours		600 000 hours	appr. 600 000 hours
Dimensions (W x H x D)	45 x 75 x 91 mm				
Weight	240 g	250 g	230 g	240 g	260 g
Certifications/Standards*	1, 2, 3, 5, 6				
Special Features	NEC Class 2 power supply			Output voltage adjustable: DC ±12V without jumper or DC ±15V with jumper; NEC Class 2 power supply	Output voltage adjustable: DC 12...15V without jumper or DC 15V with jumper; NEC Class 2 power supply





					
	1606-XLP50E	1606-XLP50EZ	1606-XLP50F	1606-XLP72E	1606-XLP90B
Watts	24...28V/50 W		48...56V/50 W		24...28V/72 W
Input Voltage†	AC 100...240V wide range DC 85...370V			AC 100...120/220...240V manual select DC 220...375V	AC 100...120/220...240V DC 220...375V
Operational Range	85...264 V AC			85...132/184...264 V AC	
Hold-up Time	>171 ms (AC 230V) >17 ms (AC 100V)		>170 ms (AC 230V) >17 ms (AC 100V)	>40 ms (AC 230V) >25 ms (AC 100V)	>40 ms (230V) >20 ms (AC 196V, AC 100V)
Rated Input Current	<1.0 A (AC 100V) <0.6 A (AC 196V)		<1.0 A (AC 100V) <0.6 A (AC 196V)	<1.6 A (AC 100V) <0.8 A (AC 220V)	<1.9 A
Efficiency	typ. 88.5% (AC 230V)		typ. 90% (AC 230V)	typ. 89% (AC 230V)	typ. 88.5%
Output Voltage	24...28V 24.5V preset		48...56V 48V preset	24...28V 24.5V preset (at 2.9 A)	12...15V Preset at 12V
Rated Output Current	2.1 A (at 24.5V), 1.8 A (at 28V)		1.05 A (at 48V), 0.9 A (at 56V)	3 A (at 24V), 2.6 A (at 28V)	7.5 A (at 12V), 6 A (at 15V)
Ripple/Noise	<50 mV _{pp} (20 MHz)		<200 mV _{pp} (20MHz)	<50 mV _{pp} (20MHz)	<50 mV _{pp} (20MHz)
Operating Temperature Range (T_{amb})	-10...+70 °C >60 °C: 1 W/K derating		-10...+70 °C >60 °C: 1.5 W/K derating	-10...+70 °C >60 °C: 1.5 W/K derating	-10...+70 °C >60 °C: 1 W/K derating
MTBF‡	appr. 600 000 hours		appr. 600 000 hours	appr. 600 000 hours	<500,000 hours
Dimensions (W x H x D)	45 x 75 x 91 mm		45 x 75 x 91 mm	45 x 75 x 91 mm	73 x 75 x 103 mm
Weight	240 g		260 g	260 g	360 g
Certifications/Standards*	1, 2, 3, 5, 6		1, 2, 3, 5, 6	1, 2, 3, 5, 6	1,2,3,5,6,7
Special Features	NEC Class 2 power supply	Removeable Terminations	NEC Class 2 power supply	NEC Class 2 power supply	





* 1) = CE, 2) = UL508 (cULus LISTED), 3) = UL1950 (cURus), 5) Safety standards = IEC/EN 60950, EN 50178, 6) EMC standards = EN 50081-1, EN 61000-6-2, 7) EN 61000-3-2 (A14)

† 47...63Hz

‡ MTBF determined by Siemens norm SN 29500 at full load current and 40 °C

1606-XLP Compact Single Phase and 1606-XL Single Phase Specifications

					
	1606-XLP100E	1606-XLP100F	1606-XL60D	1606-XL120D	1606-XL180B
Watts	24...28V/100 W	48...56V/100 W	24V/60 W	24...28V/120 W	12...15V/180 W
Input Voltage†	AC 100...120/220...240V, auto select, DC 220...375V		AC 100...120/200...240V, Manual select, DC 160...375V	AC 100...120/200...240V, Manual select, DC 210...375V	AC 100...120/220...240V DC 240...375V
Operational Range	85...132/184...264 V AC		85...132/176...264 V AC		85...132/176...264 V AC
Hold-up Time	>40 ms (AC 230V) >20 ms (AC 100V)		>20 ms (AC 196V)	>37 ms (AC 196V)	>81 ms (AC 230V) >84 ms (AC 120V) >45 ms (AC 100V)
Rated Input Current	<2.1 A (AC 100V) <1.0 A (AC 220V)		<1.3 A/<0.7A	<2.6 A/<1.4 A	<5A
Efficiency	typ. 90% (AC 230V)		typ. 87.5%	typ. 90%	>87%
Output Voltage	24...28V 24.5V preset	48...56V 48V preset	24V	24V	12...15V Preset at 12V
Rated Output Current	4.2 A (at 24.5V), 3.6 A (at 28V)	2.1 A (at 48V), 1.8 A (at 56V)	2.5 A	5 A	15 A (at 12V), 12 A (at 15V)
Power Boost				6 A	
Ripple/Noise	<50 mV _{pp} (20MHz)		<25 mV _{pp}	<50 mV _{pp}	<50 mV _{pp}
Operating Temperature Range (T_{amb})	-10...+70 °C >60 °C: 2 W/K derating		-10...+70 °C >60 °C with derating		0...70 °C >60 °C with derating
MTBF*	appr. 500,000 hours		740 000 hours	520 000 hours	<425,000 hours
Dimensions (W x H x D)	73 x 75 x 103 mm		49 x 124 x 102 mm	64 x 124 x 102 mm	120 x 124 x 102 mm
Weight	360 g		460 g	620 g	980 g
Certifications/Standards*	1, 2, 3, 5, 6,	1, 2, 3, 5, 6,	1, 2, 3, 5, 6, 7	[empty]	1,2,3,5,6
Special Features	Single/parallel operation (inclined characteristic) select on front panel				

					
	1606-XL240E	1606-XL240EP	1606-XL240FP	1606-XL480E	1606-XL480EP
Watts	24...28V/240 W	24...28V/240 W	48...56V/240 W	24...28V/480 W	
Input Voltage†	AC 100...120/200...240V, Manual select, DC 240...375V			AC 200...240V DC 270...370V	AC 100...120/200...240V Auto select
Operational Range	85...132/176...264 V AC			184...264 V AC	85...132/184...264 V AC
Hold-up Time	>25 ms (AC 196V)	>20 ms (AC 196V)	>25 ms (AC 196V)	30 ms (AC 230V)	
Rated Input Current	<6 A/<2.8 A			5 A	10 A/5 A
Efficiency	typ. 90%	typ. 89%	typ. 90%	typ. 91%	typ. 90.5%
Output Voltage	24...28V 24.5V preset	24...28V 24.5V preset	48...56V 48.5V preset	24...28V Front panel potentiometer	
Rated Output Current	10 A (at 24V), 8.6 A (at 28V)		5 A (at 48V), 4.3 A (at 56V)	20 A (at 24V), 18 A (at 28V)	
Power Boost	12 A			25 A (22 A)	
Ripple/Noise	<30 mV _{pp}	<30 mV _{pp}	<50 mV _{pp}	< 20 mV _{pp} (single operation) <40 mV _{pp} (parallel operation)	
Operating Temperature Range (T_{amb})	0...+70 °C >60 °C with derating				
MTBF*	425 000 hours	225 000 hours	425,000 hours	519 000 hours	
Dimensions (W x H x D)	120 x 124 x 102 mm			220 x 124 x 102 mm	
Weight	980 g	1195 g	980 g	1800 g	2500 g
Certifications/Standards*	1, 2, 3, 5, 6	1, 2, 3, 5, 6, 7		1,2,3,5,6	1,2,3,5,6,7
Special Features	§	PFC choke, §		Single/parallel operation (inclined characteristic) selectable (jumper), ‡	PFC choke, Overload behavior selectable (hiccup/continuous current), ‡

* 1) = CE, 2) = UL508 (cULus LISTED), 3) = UL1950 (cURus), 5) Safety standards = IEC/EN 60950, EN 50178, 6) EMC standards = EN 55011 (Class B), EN 55022 (Class B), EN 61000-6-2, 7) = EMC standards = EN 61000-3-2 (A14), EN 50081-1



† 47...63Hz

‡ Low inrush current





§ FM Class 1 Div. 2, Groups A,B,C,D T3A

* MTBF determined by Siemens norm SN 29500 at full load current and 40 °C

1606-XL Single Phase Specifications, Continued

			
	1606-XL480EPT	1606-XL480GP	1606-XL480F
Watts	24...28V/480 W	36...43V/480 W	48...56V/480 W
Input Voltage†	AC 100...120/200...240V, Auto select		
Operational Range	85...132/184...264 V AC		
Hold-up Time	30 ms (AC 230V)	>27 ms (AC 230V)	30 ms (AC 230V)
Rated Input Current	10 A/5 A		
Efficiency	typ. 90.5%	typ. 92%	typ. 93%
Output Voltage	24...28V Front panel potentiometer	36...43V/480 W Front panel potentiometer	48...56V Front panel potentiometer
Rated Output Current	20 A (at 24V), 18 A (at 28V)	13.0 A (at 36V), 11.2 A (at 43V)	10 A (at 48V), 8.6 A (at 56V)
Power Boost	25 A (22 A)	16.6 A (14 A)	12.5 A (10.7 A)
Ripple/Noise	< 20 mV _{pp} (single operation) < 40 mV _{pp} (parallel operation)	< 30 mV _{pp} (single operation) < 80 mV _{pp} (parallel operation)	< 40 mV _{pp} (single operation) < 80 mV _{pp} (parallel operation)
Operating Temperature Range (T_{amb})	0...+70 °C >60 °C with derating		
MTBF*	519 000 hours		
Dimensions (W x H x D)	220 x 124 x 102 mm		[empty]
Weight	2500 g		1800 g
Certifications/Standards*	1, 2, 3, 5, 6, 7		1, 2, 3, 5, 6
Special Features	PFC choke, ‡	Selectable single/parallel operation (inclined characteristic), PFC choke, ‡	‡

1606-XL Three Phase Specifications

				
	1606-XL120E-3	1606-XL240E-3	1606-XL480E-3	1606-XL480E-3W
Watts	24...28V/120 W	24...28V/240 W	24...28V/480 W	24...28V/490 W
Input Voltage†	3Ø AC 400...500V, wide range, DC 450...820V	3Ø AC 400...500V, wide range, DC 450...820V	3Ø AC 480V DC 550...820V	3Ø AC 400...500V, wide range, DC 450...820V
Operational Range	340...576 V AC		408...576 V AC	340...576 V AC
Hold-up Time	>16 ms (3Ø AC 400V) >10 ms (2Ø AC 400V)	>24 ms (3Ø AC 400V) >20 ms (2Ø AC 400V)	>11 ms	>11 ms (3Ø AC 400V)
Rated Input Current	3 x 0.5 A	3 x 0.8/0.7 A @400/500V	3 x 1.5 A	
Efficiency	typ. 89% (400V)	typ. 91.2% (400V) typ. 92% (500V)	typ. 92%	typ. 92% (400V)
Output Voltage	24...28V 24.5V preset	24...28V 24.5V preset	24...28V 24V preset	24...28V 24.5V preset
Rated Output Current	5 A (at 24V), 4.3 A (at 28V)	10 A (at 24V), 8.6 A (at 28V)	20 A (at 24V), 18 A (at 28V)	
Power Boost	6 A	12 A (up to 288 W)	25 A	
Ripple/Noise	<25 mV _{pp}	<30 mV _{pp}	<20 mV _{pp}	<30 mV _{pp}
Operating Temperature Range (T_{amb})	-10...+70 °C >60 °C with derating		0...+70 °C >60 °C with derating	
MTBF*	410 000 hours	543 000 hrs. (3-ph), 525 000 hrs. (2-ph)	310 000 hours	504 000 hours
Dimensions (W x H x D)	73 x 124 x 117 mm	89 x 124 x 117 mm	220 x 124 x 102 mm	150 x 124 x 121 mm
Weight	730 g	980 g	1800 g	
Certifications/Standards*	1, 2, 3, 5, 6, 7			
Special Features	PFC choke	Overload behavior selectable (FUSE Mode/continuous current), 2-phase operation admissible, Single/parallel operation (inclined characteristic), PFC choke. ‡	Single/parallel operation (inclined characteristic) selectable (jumper), PFC choke, ‡	Single/parallel operation (inclined characteristic) selectable, Overload behavior selectable (FUSE Mode/continuous current), PFC choke, ‡

* 1) = CE, 2) = UL508 (cULus LISTED), 3) = UL1950 (cURus), 5) Safety standards = IEC/EN 60950, EN 50178, 6) EMC standards = EN 55011 (Class B), EN 55022 (Class B), EN 61000-6-2, 7) = EMC standards = EN 61000-3-2 (A14), EN 50081-1





† 47...63Hz

‡ Low inrush current

§ FM Class 1 Div. 2, Groups A,B,C,D T3A

* MTBF determined by Siemens norm SN 29500 at full load current and 40 °C

1606-XL Three Phase Specifications, Continued

				
	1606-XL480F-3H	1606-XL720E-3	1606-XL960E-3	1606-XL960E-3S
Watts	48...56V/480 W	24...28V/720 W	24...28V/960 W	
Input Voltage†	3Ø AC 400V DC 450...700V	3Ø AC 400...500V wide range DC 450...820V	3Ø AC 400...500V wide range	
Operational Range	340...479 V AC			
Hold-up Time	>11 ms	>10 ms (3Ø AC 400V)	>15 ms (3Ø AC 400V)	
Rated Input Current	3 x 1.5 A	3 x 2.0 A	3 x 3.0 A	
Efficiency	typ. 92%	typ. 92.5% (400V)	typ. 92.5% (400V)	
Output Voltage	48...56V 48.1V preset	24...28V front panel potentiometer	24...28V front panel potentiometer	
Rated Output Current	10 A (at 48V), 9 A (at 56V)	30 A (at 24V), 26 A (at 28V)	40 A (at 24V), 35 A (at 28V)	
Power Boost	12.5 A	33 A	46 A	
Ripple/Noise	<50 mV _{PP}	<20 mV _{PP} (single operation) <40 mV _{PP} (parallel operation)	<50 mV _{PP}	
Operating Temperature Range (T_{amb})	0...+70 °C >60 °C with derating			
MTBF§	310 000 hours	425 000 hrs. @ AC 400V, 360 000 hrs. @ AC 480V	305 000 hours	268 000 hours
Dimensions (W x H x D)	220 x 124 x 102 mm	240 x 124 x 112 mm	275 x 124 x 117 mm	
Weight	1800 g	2000 g	3300 g	
Certifications/Standards*	1, 2, 3, 5, 6, 7			
Special Features	Single/parallel operation (inclined characteristic) selectable (jumper), PFC choke, ‡	PFC choke, ‡	Single/parallel operation (inclined characteristic) selectable (jumper), passive load sharing, PFC choke, ‡	Parallel operation through active current sharing; Output signals (Power-Fail, Shut-Down, internal current measurement, overtemperature warning), PFC choke, ‡

* 1) = CE, 2) = UL508 (cULus LISTED), 3) = UL1950 (cURus), 5) Safety standards = IEC/EN 60950, EN 50178, 6) EMC standards = EN 55011 (Class B), EN 55022 (Class B), EN 61000-6-2, 7) = EMC standards = EN 61000-3-2 (A14), EN 50081-1

† 47...63Hz

‡ Low inrush current

§ MTBF determined by Siemens norm SN 29500 at full load current and 40 °C

♣ 1606-XL960E-3S Signalling details below:

“Shut Down” Input

Function: Turning the unit on or off using logic signal (remote monitoring). Unit switches off when Input is connected to “Signal GND” terminal (DU ≤ 1V) or the input has a voltage of +20...28V with respect to the “Signal GND” terminal (max. 20 mA).

“DC Ok” Output

Function: Indicating whether the unit is operating properly. Output can directly energize a relay or a control light.

Signalling: Output signal is at a “high” level (24V, current source) in normal operation (no overload, overheating, short circuit). When the output signal switches to “low” level (no power at output), V_{out} remains for 5 ms (nominal) at nominal load.

Connection (signal common): Connection is made with respect to the “Signal GND” terminal (signal output).

Important: Do not connect to the power output (terminals + and -).

Permissible load: resistance - min. 300 Ω, e.g. 24V relay, control lights (LEDs need no series resistance), Evaluation logic.

For 5V signal: In order to receive a 5V signal: switch a 5V Zener diode (0.5 W) and 1 k ohm resistance in parallel between this output and the “Signal GND” terminal.

“Thermal Alarm” Output

Function: Output gives warning shortly before and while overtemperature state occurs. Output can directly control a relay or a control light.

Signalling: Output signal is at a “high” level (24V, current source) in normal operation (no overtemperature). At overtemperature, the output switches to “low”. Only when the temperature in the unit increases further will the unit reduce its output current (power output).

Connection and permissible load: same as for “DC ok” output.

“Current Monitor” Output

Function: Measuring the output current (power output). Output signal is proportional to the output current of the unit.

Connection: Made with respect to the “Signal GND” terminal (signal output).

Important: Do not connect to the power output (terminals + and -).

Signalling: Voltage measuring: Voltage at signal output is 1V per 10 A output current (R_i(voltmeter) > 100 k ohm)
Current measurement: Current at signal output is 1 mA per 10 A output current (R_i(ammeter) < 100 W)

“Current Balance” In-/Output

Function: Using these terminals, parallel operating units ensure an equal load sharing (active balancing). Balancing also works reliably with decoupling diodes at the power output (redundancy).

Connection: Connect together “Current Balance” outputs of all units involved.

Important: Signal common here is the - terminal of the power output, not the “Signal GND”. Do not connect the “Signal GND” terminals to each other!

“Signal GND” Terminal





Function: grounding terminal for all signal terminals (not for “Current Balance”).

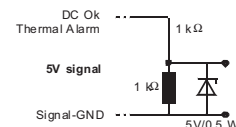
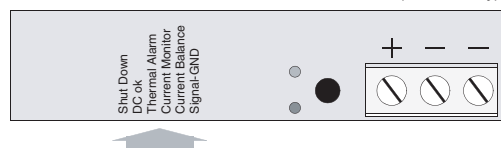



Connection instructions: Do not connect this terminal with terminals + or - of the unit (not even over a load: risk of overload). Do not connect this terminal with terminals of other units (not even with the “Signal GND” terminal of another unit).

Permissible load: Maximum current load: 0.3 A. Terminal is fused internally with a self-healing fuse (polyswitch).



1606-XL Special Modules

					
	Buffer Module	DC/DC Converter	—	—	N+1 Redundancy
	1606-XLBUFFER	1606-XLDC40A	1606-XLDNET4	1606-XLDNET8	1606-XL60DR
Watts	22.5V...27.8V/480 W	DC 5.1V ±1%	24V/120 W	24V/240 W	24V/60 W
Input Voltage†	DC 24V (DC 24...28.8V)	DC 18...36V	AC 100...120V/ 200...240V Manual select DC 210...375V	AC 100...120V/ 200...240V Manual select DC 240...375V	AC 100...120V/ 200...240V Manual select DC 160...375V
Operational Range	23...35 V DC	18...36 V DC	85...132/176...264 V AC		
Hold-up Time	>0.2s (20 A)	>10 ms (DC 24 Vin)	>37 ms (AC 196V)	>25 ms (AC 196V)	>20 ms (AC 196V)
Rated Input Current	charging current <600 mA	<2.9 A/<1.5 A	<2.6 A/<1.4 A	<6 A/<2.8 A	<1.3 A/<0.7 A
Efficiency	N/A	typ. 82%	typ. 90%	typ. 89%	typ. 86.5%
Output Voltage	Vin -1V: 23...27.8V 22.5V fixed	DC 5.1V ±1% selectable from 4.5 to 5.5V	24V	24V	24V
Rated Output Current	0...20 A	8 A	*4 A	*8 A	2.5 A
Power Boost	—	N/A	N/A	N/A	—
Ripple/Noise	<200 mV _{PP}	<50 mV _{PP}	<50 mV _{PP}	<30 mV _{PP}	<30 mV _{PP}
Operating Temperature Range (T _{amb})	-10 °C...+70 °C >60 °C with derating	0...+70 °C >60 °C with derating	-10 °C...+70 °C >60 °C with derating	0...+70 °C >60 °C with derating	-10 °C...+70 °C >60 °C with derating
MTBF§	480,000 hours	510,000 hours	520,000 hours	390,000 hours	700,000 hours
Dimensions (W x H x D)	64 x 124 x 102 mm	49 x 124 x 102 mm	64 x 124 x 102 mm	120 x 124 x 102 mm	49 x 124 x 102 mm
Weight	740 g	470 g	620 g	980 g	470 g
Certifications/Standards*	under preparation: 1, 2, 3, 5 (6, 7)	1, 5, 6	1, 2, 3, 5, 6, 7	1, 2, 3, 5, 6	1, 2, 3, 5, 6, 7
Special Features	Selectable buffered voltage, ‡	MOSFET inverse battery protection, ‡	*Electronically limited to 4 A	*Electronically limited to 8 A; RDY relay contact, N+1 redundancy, plug connectors	RDY relay contact, N+1 redundancy, plug connectors

					
	N+1 Redundancy	N+1 Redundancy	N+1 Redundancy	N+1 Redundancy	N+1 Redundancy
	1606-XL120DR	1606-XL240DR	1606-XLRED20-30	1606-XLRED40	1606-XLPRED
Watts	24V/120 W	24V/240 W	30 A Dual redundancy module	40 A Single redundancy module	13 A Compact redundancy
Input Voltage†	AC 100...120/ 200...240V manual select DC 210...375V	AC 100...120/ 200...240V manual select DC 240...375V	DC 24V (max. 35V)		DC 10 - 60V
Operational Range	85...132/176...264 V AC		18...36 V DC		10 - 60V DC
Hold-up Time	>37 ms (AC 196V)	>25 ms (AC 196V)	—	—	—
Rated Input Current	<2.6 A/<1.4 A	<6 A/<2.8 A	20...30 A (max. 35 A)	0...40 A (max. 50 A)	2 x 8 A
Efficiency	typ. 89%	typ. 89%	>97%	>97%	—
Output Voltage	24V	24V	Vin -0.5V typ.	Vin -0.6V typ.	Vin -0.9V typ.
Rated Output Current	5 A	10 A	20...30 A (max. 35 A)	0...40 A (max. 50 A)	10 A
Power Boost	6 A	12 A	—	—	—
Ripple/Noise	>30 mV _{PP}	>30 mV _{PP}	—	—	—
Operating Temperature Range (T _{amb})	-10...+70 °C >60 °C with derating	0...+70 °C >60 °C with derating	-10 °C...+70 °C		
MTBF§	480,000 hours	390,000 hours	—	—	—
Dimensions (W x H x D)	64 x 124 x 102 mm	120 x 124 x 102 mm	48 x 124 x 102 mm	48 x 124 x 117 mm	45 x 75 x 91 mm
Weight	620 g	980 g	625 g	646 g	—
Certifications/Standards*	1, 2, 3, 5, 6, 7	1, 2, 3, 5, 6	1, 2, 3, 6		
Special Features	RDY relay contact, N+1 redundancy, plug connectors		Dual redundancy module for 2x35 A, N+1 redundancy	Single redundancy module for 2.5-50 A, N+1 redundancy	Redundancy for DC 10...60V applications

* 1) = CE, 2) = UL508 (cULus LISTED), 3) = UL1950 (cURus), 5) Safety standards = IEC/EN 60950, EN 50178, 6) EMC standards = EN 55011 (Class B), EN 55022 (Class B), EN 61000-6-2, 7) = EMC standards = EN 61000-3-2 (A14), EN 50081-1

† 47...63Hz

‡ Low inrush current

§ MTBF determined by Siemens norm SN 29500 at full load current and 40 °C

Approximate Dimensions and Wire Size

Approximate dimensions are shown in inches (mm) unless otherwise indicated. Dimensions are not to be used for manufacturing purposes.

Bulletin 1606 Dimensions Table

Catalog Number	W	H	D*	Wire Size†
				(Input and Output unless otherwise noted)
1606-XLP25A	1.77 in (45 mm)	2.95 in (75 mm)	3.58 in (91 mm)	Input/Output† Stranded 28...12 AWG (0.3...2.5 mm ²) Solid 28...12 AWG (0.3...4 mm ²)
1606-XLP30B				
1606-XLP30E				
1606-XLP36C				
1606-XLP50B				
1606-XLP50E				
1606-XLP50F				
1606-XLP72E				
1606-XLPRED				
1606-XLP100E				
1606-XLP100F	2.87 in (73 mm)	2.95 in (75 mm)	4.06 in (103 mm)	
1606-XLP90B	4.72 in (120 mm)	4.88 in (124 mm)	4.02 in (102 mm)	Input/Output† Stranded 20...10 AWG (0.5...4 mm ²) Solid 20...10 AWG (0.5...6 mm ²)
1606-XL60D				
1606-XL120D				
1606-XL180B				
1606-XL240E				
1606-XL240EP				
1606-XL240FP				
1606-XL480E				
1606-XL480EP				
1606-XL480EPT				
1606-XL480GP	8.6 in (220 mm)	4.88 in (124 mm)	4.02 in (102 mm)	
1606-XL480F				
1606-XL120E-3	2.87 in (73 mm)	4.88 in (124 mm)	4.61 in (117 mm)	Input/Output† Stranded 20...10 AWG (0.5...4 mm ²) Solid 20...10 AWG (0.5...6 mm ²)
1606-XL240E-3				
1606-XL480E-3				
1606-XL480E-3W				
1606-XL480F-3H				
1606-XL720E-3				
1606-XL960E-3	10.83 in (275 mm)	4.88 in (124 mm)	4.61 in (117 mm)	Input† Stranded 20...10 AWG (0.5...4 mm ²) Solid 20...10 AWG (0.5...6 mm ²)
1606-XL960E-3S				Output† Stranded 22...8 AWG (0.5...10 mm ²) Solid 22...8 AWG (0.5...16 mm ²)
1606-XLBUFFER	2.56 in (64 mm)	4.88 in (124 mm)	4.02 in (102 mm)	Input/Output† Stranded 20...10 AWG (0.5...4 mm ²) Solid 20...10 AWG (0.5...6 mm ²)
1606-XLDC40A				
1606-XLDNET4				
1606-XLDNET8	4.72 in (120 mm)	4.88 in (124 mm)	4.02 in (102 mm)	Input/Output† Stranded 22...10 AWG (0.2...2.5 mm ²) Solid 22...10 AWG (0.2...2.5 mm ²)
1606-XLP50EZ	1.77 in (45 mm)	2.95 in (75 mm)	3.58 in (91 mm)	Input/Output† Stranded 22...12 AWG (0.2...2.5 mm ²) Solid 22...12 AWG (0.2...2.5 mm ²)
1606-XL60DR				
1606-XL120DR				
1606-XL240DR				
1606-XLRED20-30				
1606-XLRED40	1.89 in (48 mm)	4.88 in (124 mm)	4.61 in (117 mm)	Input/Output† Stranded 20...10 AWG (0.5...4 mm ²) Solid 20...10 AWG (0.5...6 mm ²)

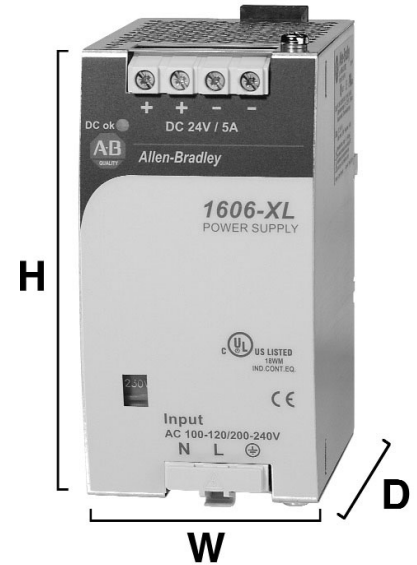

* Depth measurement does not include DIN rail.

† The wire sizes indicated refer only to the connection capability of the terminal.

For proper operation, the correct wire size must be used (based on accurate determination of the electrical characteristics and loading of the system).

1606-XLA Back of Panel Mounting Bracket for XL Power Supplies

Instead of snapping the power supply onto a DIN-rail, you also can mount it to the back of the panel. This set consists of two aluminum profiles which replace the existing profiles at the back of the unit.

Note:

- You need one set per unit.
- In addition, two screws are required per set (e.g. M5 x 12 or corresponding sheet-metal screws; they are not included in the set.)

Approximate Dimensions (mm)

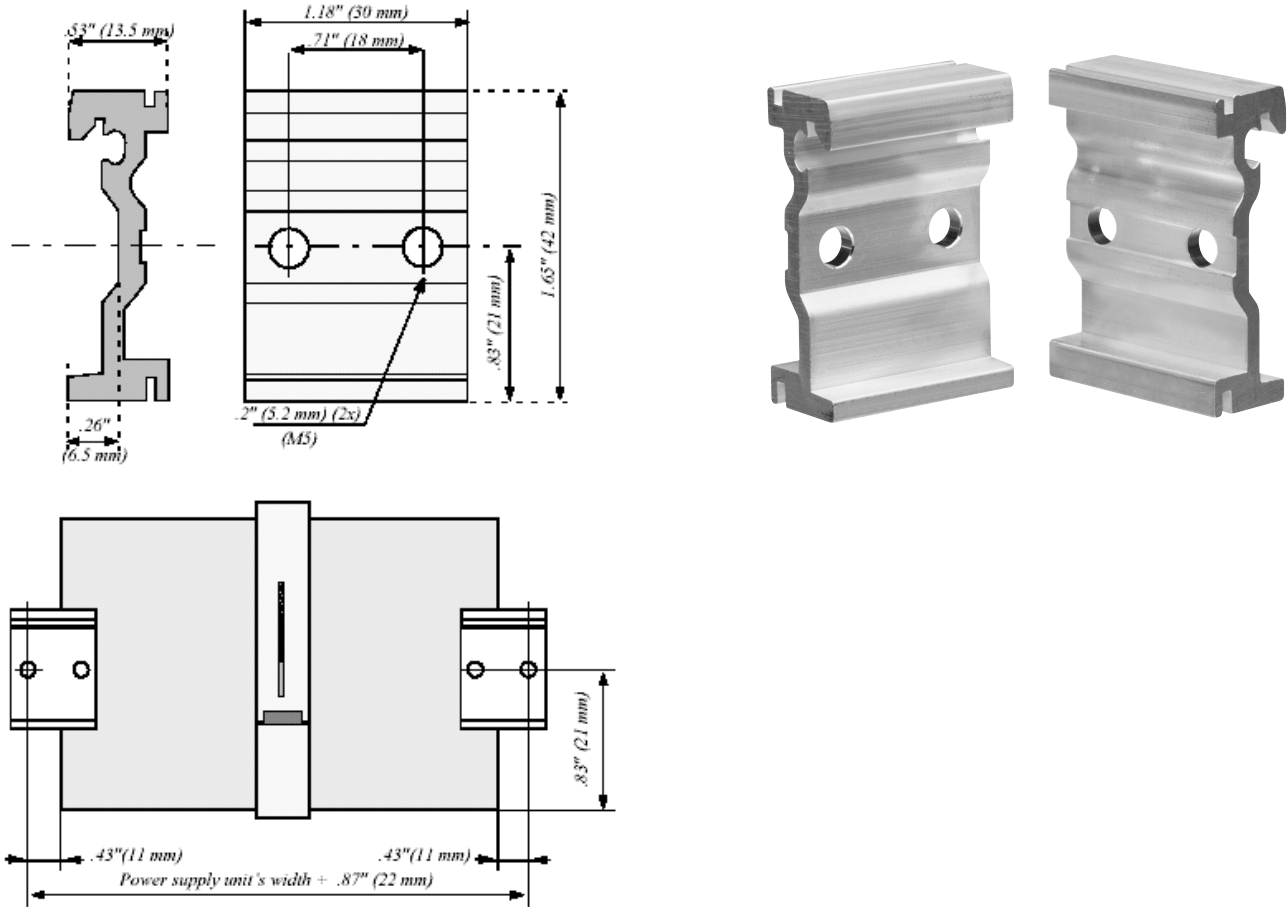

Circuit Protection Suggestions

If you intend to protect the primary side of the power supply with a fuse or a circuit breaker, this section can provide guidance on the proper Allen-Bradley product to use. In order to meet local requirements, please consult local codes and regulations for proper installation.

Power Supply Type*	Recommended Fuse	Supplementary Protector
XL480E-3W	6 A (x3) Slow acting fuse (HBC)	1492-SP3C060
XL120E-3, XL240E-3, XL480F-3H, XL480E-3, XL720E-3, XL960E-3, XL960E-3S	10 A (x3) Slow acting fuse (HBC)	1492-SP3C100
XL60D, XL60DR, XL120D, XL120DR, XL240E, XL240EP, XL240DR, XL480E, XLDNET8, XLDNET4	10 A Slow acting fuse (HBC)	1492-SPU1C100
XL480EPT, XL480F, XL480GP, XL480EP	15 A Slow acting fuse (HBC)	1492-SPU1C150†

* Products not listed have an internal input fuse. No additional product protection is required.

† For European applications, 1492-SP1C160 is recommended.

1606-XL Redundancy Capabilities

The 1606-XL family has two cost effective methods for providing redundancy to applications that are critical and can not risk failure.

1606-XL60DR, XL120DR and XL240DR Redundant Power Supplies

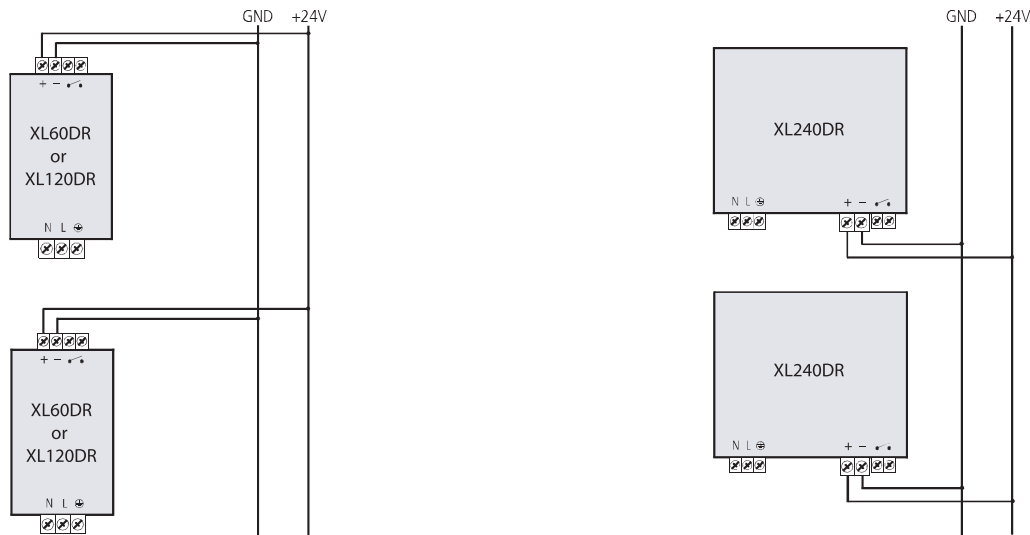

The 1606-XL60DR, XL120DR and XL240DR are enhanced versions of the standard power supplies.

- Each device has internal diodes which provide isolation against DC bus problems corrupting working supplies.
- Provides “DC ok” output relay to allow remote monitoring of DC power status.
- Utilizes pluggable terminals for easy installation.

1606-XLRED20-30 and 1606-XLRED40 Redundancy Modules

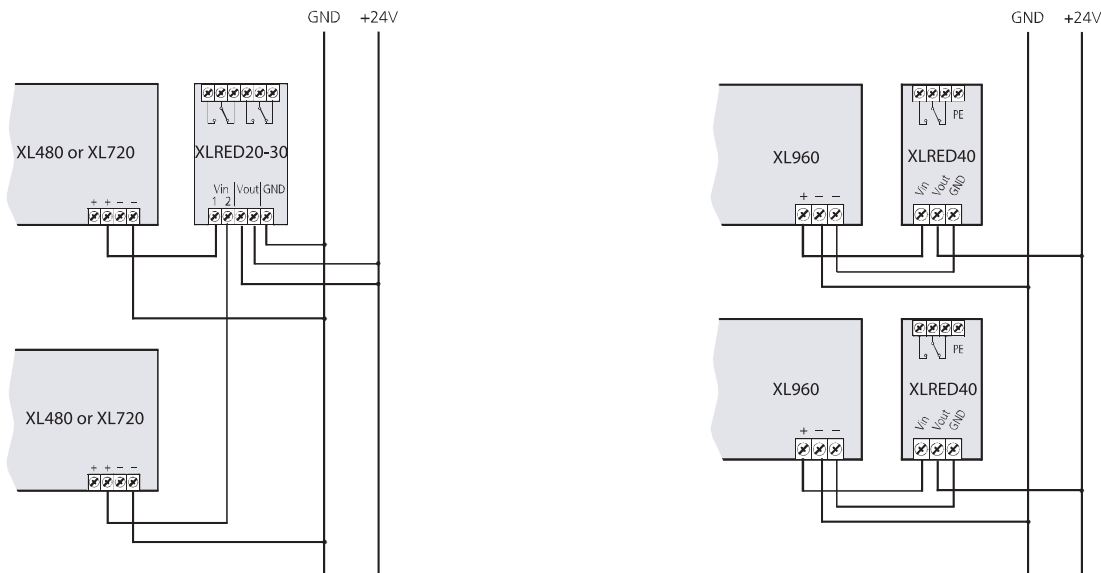

The 1606-XLRED20-30 and 1606-XLRED40 allow redundant wiring of 20 to 40 amp power supplies.

- Devices provide isolation of power supplies via diodes.
- Provide remote monitoring of DC power status of each power supply.
- A single XLRED20-30 can be used per pair of identical 20 or 30 amp power supplies.
- One XLRED40 is required for every 40 amp power supply.

1606-XLRED

- When used in 1 + 1 redundant systems (like XLRED20-30) limited to 8 A (short circuit) per power supply
- When used in NH redundant system (like XLRED40) limited to 13 A (short circuit)
- See product technical data sheets for more application information.

1606-XLBuffer

Features

- Buffering for 24V loads
- Guaranteed hold-up time: 0.2s/20A to 3.6s/1A
- Fit for industrial use: Energy storage in electrolytic caps., no accumulators
- Clear status indication by Status LED and signalling terminals
- No batteries requiring replacement

Short Description

The buffer unit is a supplementary device for regulated DC 24V power supplies. It buffers load currents during typical mains faults and switching events or load peaks.

Working principle

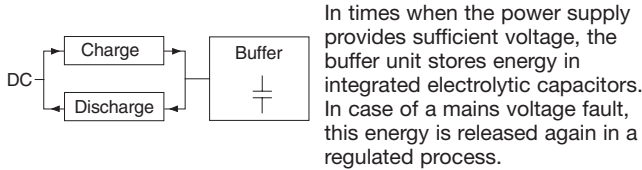

Bridges mains faults without interruption

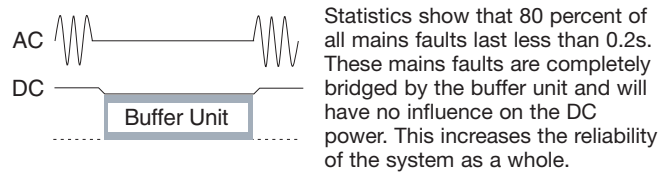

Extended hold-up time

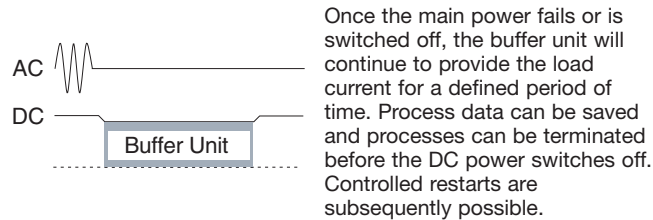

Easy to handle, expandable and maintenance-free

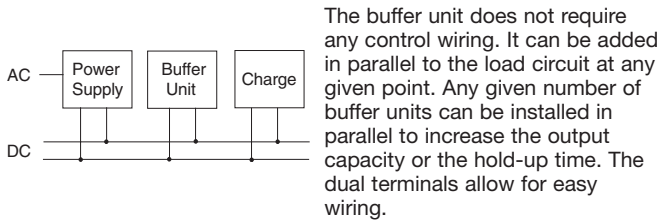

Operating Modes

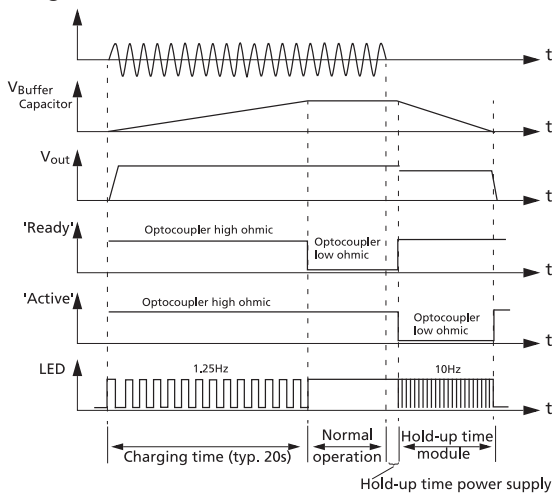

Activation Threshold

“22.5V fixed”	Buffering starts if terminal voltage <22.5V, voltage is kept at 22.5V.
“Vin -1V”	Buffering starts if terminal voltage decreases by more than 1V, faster than typ. 0.54V/s. Voltage is kept at that level. Buffering ends when voltage increases once more by 1V.
Noise (spikes)	>200mV _{PP} (20MHz bandw., 50Ω-measurement, buffer operation only)
Over voltage protection	limited to max. ±35V

Hold-up Time

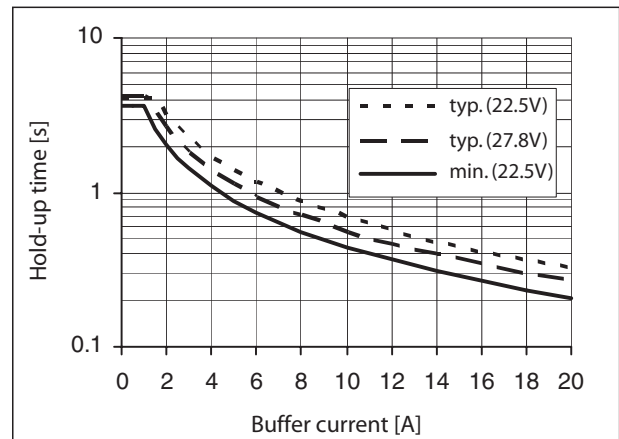

Operating Indicators and Elements

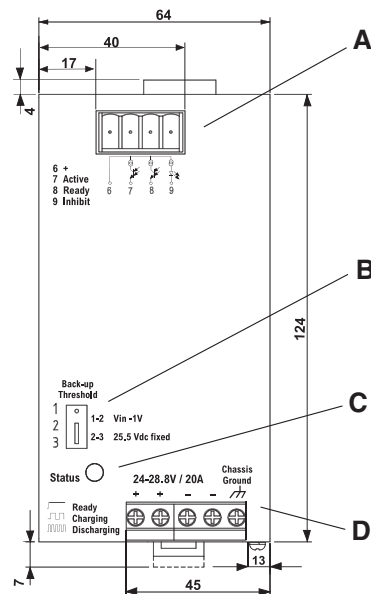

A - Signaling terminals:

- 7 Active: unit is buffering
- 8 Ready: unit is on stand-by
- 9 Inhibit: Initiates buffer recharging of capacitor array

C - Status LED

Indicates charge status of buffer capacitor array

D - Power In/Out terminals:

- + (positive)
- - (negative)
- Housing connection 'chassis ground'

B - Jumper back-up threshold:

- Position 1-2: variable: Vin -1V. Buffering if voltage decreases faster than typical 0.54V/s and greater than 1V
- Position 2-3: DC 22.5V fixed. Voltage buffering starts at Vin less than 22.5V



Cat. No. 1497-B-HXJX-3-N
Control Circuit Transformer, 3-pole
Fuse Block with Optional Cat. No.
1491-R150 Fuse Cover



Cat. No. 1497-C-BASX-0-N
Control Circuit Transformer,
Non-Fused

Bulletin 1497 — Control Circuit Transformers

63...2000 VA
Bulletin 1497 Global Control Circuit Transformers are designed to reduce supply voltages to control circuits. The complete line of transformers is available with optional factory-installed or panel-mount primary and secondary fuse block. A dual primary and secondary fuse block is pre-wired and mounted on top of the transformer up to 500 VA. Bulletin 1497 offers single, dual, and multi-tap primary voltages.

Table of Contents

Product Selection ... 8-14
Transformer Cross Reference 8-15
Accessories 8-20
Approximate Dimensions 8-21

Standards Compliance

- IEC, EN61558
- NEMA, ICS2-1993, Part 1 Sect. 9.2
- UL 506, For Class 105 XFMRs

Certifications

- cULus

Your order must include the cat. no. of the control circuit transformer selected.

Cat. No. Explanation

Bulletin 1497 Multi-Tap Transformers

1497 - A - M1 - 3 - N
 a b c d

a

VA Rating	
Code	Description
A	63 VA
B	80 VA
C	130 VA
D	200 VA
E	250 VA
F	350 VA
G	500 VA
H	750 VA
J	800 VA
K	1000 VA
L	1600 VA
M	2000 VA

b

Primary and Secondary Voltage		
Code	Primary	Secondary
M1	240V, 208V	120V (60 Hz)
M2	240V, 208V	24V (60 Hz)
M3	240V, 208V	24V, 120V (60 Hz)
M4	415V, 400V, 380V	115V, 230V (50 Hz)
M5	415V, 400V, 380V	24V (50 Hz)

c

Fuse Block Options	
Code	Block Options
0	0 Primary, 0 Secondary
1	0 Primary, 1 Secondary
2	2 Primary, 0 Secondary
3	2 Primary, 1 Secondary

d

Factory Installed Options	
Code	Description
N	No Secondary Fuse, No Cover

Bulletin 1497 Transformers

1497 - A - BADX - 3 - N
 a b c d

a

VA Rating	
Code	Description
A	63 VA
B	80 VA
C	130 VA
D	200 VA
E	250 VA
F	350 VA
G	500 VA
H	750 VA
J	800 VA
K	1000 VA
L	1600 VA
M	2000 VA

b

Primary and Secondary Voltage		
Code	Primary	Secondary
HX	208V (60 Hz)	—
AX	240V (60 Hz), 220V (50 Hz)	—
BA	240/480V (60 Hz), 220/440V (50 Hz)	—
CX	600V (60 Hz), 550V (50 Hz)	—
DX	—	120V (60 Hz)
JX	—	24V (60 Hz)
SX	—	120V (60 Hz), 110V (50Hz)
JK	—	24V (50 and 60 Hz)

c

Fuse Block Options	
Code	Block Options
0	0 Primary, 0 Secondary
1	0 Primary, 1 Secondary
2	2 Primary, 0 Secondary
3	2 Primary, 1 Secondary

d

Factory Installed Options	
Code	Description
N	No Secondary Fuse, No Cover

Control Circuit Transformers

Product Selection

Selecting a Control Circuit Transformer

For proper transformer selection, three characteristics of the load circuit must be determined in addition to the minimum voltage required to operate the circuit. These are total steady-state (sealed) VA, total inrush VA, and inrush load power factor.

- Total steady-state (sealed) VA is the volt-amperes that the transformer must deliver to the load circuit for an extended period of time — the amount of current required to hold the contact in the circuit.
- Total inrush VA is the volt amperes that the transformer must deliver upon initial energization of the control circuit. Energization of electromagnetic devices takes 30...50 milliseconds. During this inrush period, the electromagnetic control devices draw many times normal current — 3...10 times normal is typical.
- Inrush load power factor is difficult to determine without detailed vector analysis of all the load components. Such an analysis is generally not feasible. Therefore, a safe assumption is 40% power factor.

Selection Process

1. Determine the total inrush VA of the control circuits from the table below, *Typical Magnetic Motor Starter and Contactor Data 60 Hz, 120 Volt, 3-Pole*. Do not neglect the current requirements of indicating lights and other devices that do not have an inrush VA but are re-energized at the same time as the other components in the circuit. Their total VA should be added to the total inrush VA.
2. Refer to the table below, *Regulation Data — Inrush VA*. If the supply circuit voltage (Step 1) is reasonably stable and fluctuates not more than $\pm 5\%$, refer to the 90% secondary voltage column. If it fluctuates as much as $\pm 10\%$, refer to the 95% secondary voltage column. Go down the column selected until at the inrush VA closest to, but not less than, the inrush VA of the control circuit.
3. Read to the far left side of the chart. The transformer's continuous nominal VA rating is now selected. The secondary voltage that will be delivered under inrush conditions will be either 85%, 90%, or 95% of the rated secondary voltage, depending on the column selected from the table below, *Regulation Data — Inrush VA*. The total sealed VA of the control circuit must not exceed the nominal VA rating of the transformer selected from the table below, *Typical Magnetic Motor Starter and Contactor Data 60 Hz, 120 Volt, 3-Pole*.
4. Refer to the specification tables on the following pages to select a transformer according to the required continuous nominal VA, and primary and secondary voltage combinations.

Regulation Data — Inrush VA

Nominal VA Rating	Inrush VA at 40% Power Factor			Power Factor Adjustments	
	85%	90%	95%	Power Factor	Multiply By
63	347	289	216	100%	0.64
80	338	290	229	90%	0.67
130	907	745	541	80%	0.71
200	1267	1039	754	70%	0.78
250	1394	1116	781	60%	0.82
350	2870	2298	1584	50%	0.91
500	3786	3013	2065	40%	1.00
750	7360	5763	3786	30%	1.11
800	7360	5763	3786	20%	1.29
1000	8837	6785	4329	10%	1.50
1600	14921	11328	7070	—	—
2000	20500	14850	9100	—	—

Typical Magnetic Motor Starter and Contactor Data 60 Hz, 120 Volt, 3-Pole

Contactor	NEMA Size						
	0	1	2	3	4	5	
Bulletin 500	192	192	240	660	1225	1490	VA Inrush
	29	29	29	45	69	96	VA Sealed

Transformer Replacement — Top Mounted Fuse Block — Fuses Not Included

VA	Cat. Nos.			
	Secondary 24V (60 Hz)		Secondary 120V (60 Hz)	
	Previous	Current	Previous	Current
	Primary 208V (60 Hz)			
63	1497-N45P	1497-A-HXJX-3-N	1497-N28P	1497-A-HXDX-3-N
80	1497-N48P	1497-B-HXJX-3-N	1497-N1P	1497-B-HXDX-3-N
130	1497-N51P	1497-C-HXJX-3-N	1497-N15P	1497-C-HXDX-3-N
200	1497-N54P	1497-D-HXJX-3-N	1497-N4P	1497-D-HXDX-3-N
250	1497-N57P	1497-E-HXJX-3-N	1497-N7P	1497-E-HXDX-3-N
350	1497-N60P	1497-F-HXJX-3-N	1497-N10P	1497-F-HXDX-3-N
500	1497-N63P	1497-G-HXJX-3-N	1497-N18P	1497-G-HXDX-3-N
VA	Primary 240/480V (60 Hz)*			
63	1497-N46P	1497-A-BAJK-3-N	1497-N27P	1497-A-BASX-3-N
80	1497-N49P	1497-B-BAJK-3-N	1497-N2P	1497-B-BASX-3-N
130	1497-N52P	1497-C-BAJK-3-N	1497-N16P	1497-C-BASX-3-N
200	1497-N55P	1497-D-BAJK-3-N	1497-N5P	1497-D-BASX-3-N
250	1497-N58P	1497-E-BAJK-3-N	1497-N8P	1497-E-BASX-3-N
350	1497-N61P	1497-F-BAJK-3-N	1497-N11P	1497-F-BASX-3-N
500	1497-N64P	1497-G-BAJK-3-N	1497-N19P	1497-G-BASX-3-N
VA	Primary 600V (60 Hz)†			
50	1497-N47P	1497-N47P	1497-N29P	1497-N29P
75	1497-N50P	1497-N50P	1497-N3P	1497-N3P
130	1497-N53P	1497-N53P	1497-N17P	1497-N17P
200	1497-N56P	1497-D-CXJK-3-N	1497-N6P	1497-D-CXSX-3-N
250	1497-N59P	1497-E-CXJK-3-N	1497-N9P	1497-E-CXSX-3-N
350	1497-N62P	1497-F-CXJK-3-N	1497-N12P	1497-F-CXSX-3-N
500	1497-N65P	1497-G-CXJK-3-N	1497-N20P	1497-G-CXSX-3-N

* Also rated 220/440V Primary, 110V Secondary 50 Hz, and 220/440V Primary, 24V Secondary 50 Hz.

† Also rated 550V Primary, 110V Secondary 50 Hz, and 550V Primary, 24V Secondary 50 Hz.

Control Circuit Transformers

Product Selection, Continued

Transformer Replacement — No Fuse Block

VA	Cat. Nos.			
	Secondary 24V (60 Hz)		Secondary 120V (60 Hz)	
	Previous	Current	Previous	Current
	Primary 208V (60 Hz)			
63	1497-N45	1497-A-HXJX-0-N	1497-N28	1497-A-HXDX-0-N
80	1497-N48	1497-B-HXJX-0-N	1497-N1	1497-B-HXDX-0-N
130	1497-N51	1497-C-HXJX-0-N	1497-N15	1497-C-HXDX-0-N
200	1497-N54	1497-D-HXJX-0-N	1497-N4	1497-D-HXDX-0-N
250	1497-N57	1497-E-HXJX-0-N	1497-N7	1497-E-HXDX-0-N
350	1497-N60	1497-F-HXJX-0-N	1497-N10	1497-F-HXDX-0-N
500	1497-N63	1497-G-HXJX-0-N	1497-N18	1497-G-HXDX-0-N
750	—	1497-H-HXJX-0-N	1497-N33	1497-H-HXDX-0-N
1000	—	1497-K-HXJX-0-N	1497-N36	1497-K-HXDX-0-N
1500	—	1497-L-HXJX-0-N	1497-N39	1497-L-HXDX-0-N
2000	—	1497-M-HXJX-0-N	1497-N42	1497-M-HXDX-0-N
VA	Primary 240/480V (60 Hz)‡			
63	1497-N46	1497-A-BAJK-0-N	1497-N27	1497-A-BASX-0-N
80	1497-N49	1497-B-BAJK-0-N	1497-N2	1497-B-BASX-0-N
130	1497-N52	1497-C-BAJK-0-N	1497-N16	1497-C-BASX-0-N
200	1497-N55	1497-D-BAJK-0-N	1497-N5	1497-D-BASX-0-N
250	1497-N58	1497-E-BAJK-0-N	1497-N8	1497-E-BASX-0-N
350	1497-N61	1497-F-BAJK-0-N	1497-N11	1497-F-BASX-0-N
500	1497-N64	1497-G-BAJK-0-N	1497-N19	1497-G-BASX-0-N
750	—	1497-H-BAJK-0-N	1497-N34	1497-H-BASX-0-N
1000	—	1497-K-BAJK-0-N	1497-N37	1497-K-BASX-0-N
1500	—	1497-L-BAJK-0-N	1497-N40	1497-L-BASX-0-N
2000	—	1497-M-BAJK-0-N	1497-N43	1497-M-BASX-0-N
VA	Primary 600V (60 Hz)§			
50	1497-N47	1497-N47	1497-N29	1497-N29
75	1497-N50	1497-N50	1497-N3	1497-N3
130	1497-N53	1497-N53	1497-N17	1497-N17
200	1497-N56	1497-D-CXJK-0-N	1497-N6	1497-D-CXSX-0-N
250	1497-N59	1497-E-CXJK-0-N	1497-N9	1497-E-CXSX-0-N
350	1497-N62	1497-F-CXJK-0-N	1497-N12	1497-F-CXSX-0-N
500	1497-N65	1497-G-CXJK-0-N	1497-N20	1497-G-CXSX-0-N
750	—	1497-H-CXJK-0-N	1497-N35	1497-H-CXSX-0-N
1000	—	1497-K-CXJK-0-N	1497-N38	1497-K-CXSX-0-N
1500	—	1497-L-CXJK-0-N	1497-N41	1497-L-CXSX-0-N
2000	—	1497-M-CXJK-0-N	1497-N44	1497-M-CXSX-0-N

‡ Also rated 220/440V Primary, 110V Secondary 50 Hz, and 220/440V Primary, 24V Secondary 50 Hz.

§ Also rated 550V Primary, 110V Secondary 50 Hz, and 550V Primary, 24V Secondary 50 Hz.

Note: Refer to page 8-14 for information on how to select a control circuit transformer.

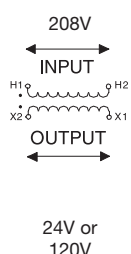
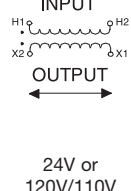
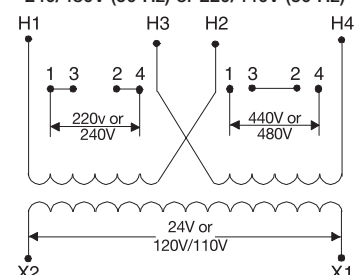
Continuous VA	Cat. Nos.					
	Primary 208V (60 Hz)		Primary 240V (60 Hz)/220V (50 Hz)		Primary 240/480V (60 Hz) or 220/440V (50 Hz)	
						
Secondary 24V (60 Hz)	Secondary 120V (60 Hz)	Secondary 24V (60 Hz)/ 24V (50 Hz)	Secondary 120V (60 Hz)/ 110V (50 Hz)	Secondary 24V (60 Hz) or 24V (50 Hz)	Secondary 120V (60 Hz) or 110V (50 Hz)	
63	1497-A-HXJX-0-N	1497-A-HXDX-0-N	1497-A-AXJK-0-N	1497-A-AXSX-0-N	1497-A-BAJK-0-N	1497-A-BASX-0-N
80	1497-B-HXJX-0-N	1497-B-HXDX-0-N	1497-B-AXJK-0-N	1497-B-AXSX-0-N	1497-B-BAJK-0-N	1497-B-BASX-0-N
130	1497-C-HXJX-0-N	1497-C-HXDX-0-N	1497-C-AXJK-0-N	1497-C-AXSX-0-N	1497-C-BAJK-0-N	1497-C-BASX-0-N
200	1497-D-HXJX-0-N	1497-D-HXDX-0-N	1497-D-AXJK-0-N	1497-D-AXSX-0-N	1497-D-BAJK-0-N	1497-D-BASX-0-N
250	1497-E-HXJX-0-N	1497-E-HXDX-0-N	1497-E-AXJK-0-N	1497-E-AXSX-0-N	1497-E-BAJK-0-N	1497-E-BASX-0-N
350	1497-F-HXJX-0-N	1497-F-HXDX-0-N	1497-F-AXJK-0-N	1497-F-AXSX-0-N	1497-F-BAJK-0-N	1497-F-BASX-0-N
500	1497-G-HXJX-0-N	1497-G-HXDX-0-N	1497-G-AXJK-0-N	1497-G-AXSX-0-N	1497-G-BAJK-0-N	1497-G-BASX-0-N
750	1497-H-HXJX-0-N	1497-H-HXDX-0-N	1497-H-AXJK-0-N	1497-H-AXSX-0-N	1497-H-BAJK-0-N	1497-H-BASX-0-N
800	1497-J-HXJX-0-N	1497-J-HXDX-0-N	1497-J-AXJK-0-N	1497-J-AXSX-0-N	1497-J-BAJK-0-N	1497-J-BASX-0-N
1000	1497-K-HXJX-0-N	1497-K-HXDX-0-N	1497-K-AXJK-0-N	1497-K-AXSX-0-N	1497-K-BAJK-0-N	1497-K-BASX-0-N
1600	1497-L-HXJX-0-N	1497-L-HXDX-0-N	1497-L-AXJK-0-N	1497-L-AXSX-0-N	1497-L-BAJK-0-N	1497-L-BASX-0-N
2000	1497-M-HXJX-0-N	1497-M-HXDX-0-N	1497-M-AXJK-0-N	1497-M-AXSX-0-N	1497-M-BAJK-0-N	1497-M-BASX-0-N
With 2-Pole Primary and 1-Pole Secondary Top-Mounted Fuse Block — Fuses Not Included						
63	1497-A-HXJX-3-N	1497-A-HXDX-3-N	1497-A-AXJK-3-N	1497-A-AXSX-3-N	1497-A-BAJK-3-N	1497-A-BASX-3-N
80	1497-B-HXJX-3-N	1497-B-HXDX-3-N	1497-B-AXJK-3-N	1497-B-AXSX-3-N	1497-B-BAJK-3-N	1497-B-BASX-3-N
130	1497-C-HXJX-3-N	1497-C-HXDX-3-N	1497-C-AXJK-3-N	1497-C-AXSX-3-N	1497-C-BAJK-3-N	1497-C-BASX-3-N
200	1497-D-HXJX-3-N	1497-D-HXDX-3-N	1497-D-AXJK-3-N	1497-D-AXSX-3-N	1497-D-BAJK-3-N	1497-D-BASX-3-N
250	1497-E-HXJX-3-N	1497-E-HXDX-3-N	1497-E-AXJK-3-N	1497-E-AXSX-3-N	1497-E-BAJK-3-N	1497-E-BASX-3-N
350	1497-F-HXJX-3-N	1497-F-HXDX-3-N	1497-F-AXJK-3-N	1497-F-AXSX-3-N	1497-F-BAJK-3-N	1497-F-BASX-3-N
500	1497-G-HXJX-3-N	1497-G-HXDX-3-N	1497-G-AXJK-3-N	1497-G-AXSX-3-N	1497-G-BAJK-3-N	1497-G-BASX-3-N

Control Circuit Transformers

Product Selection, Continued

Note: Refer to page 8-14 for information on how to select a control circuit transformer.

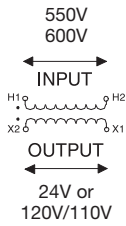
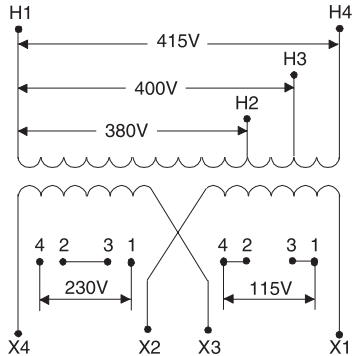
Continuous VA	Cat. Nos.		
	Secondary 24V (60 Hz)/24V (50 Hz)	Secondary 120V (60 Hz)/110V (50 Hz)	Secondary 115V/230V (50 Hz)
	<p>Primary* 600V (60 Hz)/550V (50 Hz)</p> 		<p>Primary 380V, 400V, 415V (50 Hz)</p> 
63	1497-N46	1497-N29	1497-A-M4-0-N
80	1497-N49	1497-N3	1497-B-M4-0-N
130	1497-N52	1497-N17	1497-C-M4-0-N
200	1497-D-CXJK-0-N	1497-D-CXSX-0-N	1497-D-M4-0-N
250	1497-E-CXJK-0-N	1497-E-CXSX-0-N	1497-E-M4-0-N
350	1497-F-CXJK-0-N	1497-F-CXSX-0-N	1497-F-M4-0-N
500	1497-G-CXJK-0-N	1497-G-CXSX-0-N	1497-G-M4-0-N
750	1497-H-CXJK-0-N	1497-H-CXSX-0-N	1497-H-M4-0-N
800	1497-J-CXJK-0-N	1497-J-CXSX-0-N	1497-J-M4-0-N
1000	1497-K-CXJK-0-N	1497-K-CXSX-0-N	1497-K-M4-0-N
1600	1497-L-CXJK-0-N	1497-L-CXSX-0-N	1497-L-M4-0-N
2000	1497-M-CXJK-0-N	1497-M-CXSX-0-N	1497-M-M4-0-N
With 2-Pole Primary and 1-Pole Secondary Top-Mounted Fuse Block — Fuses Not Included			
50	1497-N47P	1497-N29P	1497-A-M4-3-N
75	1497-N50P	1497-N3P	1497-B-M4-3-N
130	1497-N53P	1497-N17P	1497-C-M4-3-N
200	1497-D-CXJK-3-N	1497-D-CXSX-3-N	1497-D-M4-3-N
250	1497-E-CXJK-3-N	1497-E-CXSX-3-N	1497-E-M4-3-N
350	1497-F-CXJK-3-N	1497-F-CXSX-3-N	1497-F-M4-3-N
500	1497-G-CXJK-3-N	1497-G-CXSX-3-N	1497-G-M4-3-N

* Transformers with 600V primary do not carry the CE mark.

Fuse Sizing Charts

Important: Select the fuse to protect the control circuit conductors in accordance with the National Electrical Code.

Primary Fuse Sizing Chart (When Only Primary Protection is Used)

Maximum Amp Rating for Current Limiting Class CC Fuses Based on Transformer Primary Voltage

VA	208V	220V	240V	277V	347V	380V	400V	415V	440V	480V	500V	550V	600V	690V
63	0.75	0.75	0.75	0.5	0.5	0.4	0.4	0.4	0.4	0.25	0.25	0.25	0.25	0.25
80	1	1	1	0.75	0.5	0.5	0.5	0.5	0.5	0.5	0.4	0.4	0.4	0.25
130	1.5	1.5	1.5	1.25	1	1	0.75	0.75	0.75	0.75	0.75	0.5	0.5	0.5
200	2.5	2.5	2.5	2	1.5	1.5	1.5	1.25	1.25	1.25	1	1	1	0.75
250	3	3	3	2.5	2	1.5	1.5	1.5	1.5	1.5	1.5	1.25	1.25	1
350	5	4	4	3	3	2.5	2.5	2.5	2	2	2	1.5	1.5	1.5
500	4	3	3	5	4	3	3	3	3	3	3	2.5	2.5	2
750	6	5	5	4	3	5	5	5	5	4	4	4	3	3
800	6	6	5	4	3	3	3	5	5	5	4	4	4	3
1000	8	7	6	6	4	4	4	4	3	3	3	5	5	4
1600	12	12	11	9	7	7	6	6	6	5	5	4	4	3
2000	12	11	13	12	9	8	8	8	7	6	6	6	5	4

Primary Fuse Sizing Chart (When Primary and Secondary Protection is Used)

Maximum Amp Rating for Current Limiting Class CC Fuses Based on Transformer Primary Voltage

VA	208V	220V	240V	277V	347V	380V	400V	415V	440V	480V	500V	550V	600V	690V
63	0.75	0.75	0.5	0.5	0.4	0.4	0.4	0.4	0.3	0.3	0.3	0.25	0.25	0.25
80	1.5	1.5	1.5	1	1	1	1	0.75	0.75	0.75	0.75	0.5	0.5	0.5
130	3	2.5	2.5	2	1.5	1.5	1.5	1.5	1.25	1.25	1.25	1	1	0.75
200	4	4	4	3	2.5	2.5	2.5	2	2	2	2	1.5	1.5	1
250	6	5	5	4	3	3	3	3	2.5	2.5	2.5	2	2	1.5
350	8	7	7	6	5	4	4	4	3	3	3	3	2.5	2.5
500	6	5	5	9	7	6	6	6	5	5	5	4	4	3
750	9	8	7	6	5	9	9	9	8	7	7	6	6	5
800	9	9	8	7	5	5	5	8	8	8	8	7	6	5
1000	12	10	10	9	7	6	6	6	5	5	5	8	8	7
1600	15	15	15	12	11	10	10	9	9	8	8	7	6	5
2000	20	20	20	18	14	12	12	12	10	10	10	9	8	7

Secondary Fuse Sizing Chart

Maximum Amp Rating for Current Limiting Midget Fuses

VA	24V	110V	115V	120V	230V
63	4	0.75	0.75	0.75	0.4
80	5	1	1	1	0.5
130	9	1.8	1.8	1.8	0.9
200	13	2.5	2.5	2.5	1.25
250	15	3.2	3.2	3.2	1.5
350	20	4.5	4.5	4.5	2.5
500	30	6.25	6.25	6.25	3
750	45	9	9	9	4.5
800	45	9	9	9	4.5
1000	60	12	12	12	6
1600	100	20	20	20	10
2000	—	25	25	25	12

Control Circuit Transformers

Accessories

Fuse Block Kits — For Use when Fuse Block is Not Integrated with the Transformer

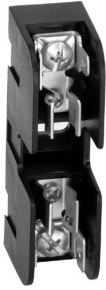

Cat. No. 1491-R165
1-Pole Fuse Block



Cat. No. 1491-R167
2-Pole Fuse Block



Cat. No. 1491-R171
3-Pole Fuse Block



Cat. No. 1491-R169
3-Pole Fuse Block



Cat. No. 1491-R150
Fuse Cover without Fuse

These control circuit fusing kits are intended to be used for control circuit transformer protection and protection of control circuits capable of delivering no more than 200 000 RMS symmetrical amps, 600V maximum.

Description*	Cat. No.
Fuse Cover — Per Pole	1491-R150
One-Pole Kit — Panel-Mounted (Midget Fuse)†	1491-R165
Two-Pole Kit — Panel-Mounted (Two Class CC Fuses)†	1491-R162
Two-Pole Kit — Panel-Mounted (Two Midget Fuses)†	1491-R167
Three-Pole Kit — Panel-Mounted (One Midget Fuse/Two Class CC Fuses)†	1491-R169
Three-Pole Kit — Panel-Mounted (Three Class CC Fuses)†	1491-R171
Single-Pole Kit — Bulletin 500 Line Controller Mounted (Class CC Fuses)‡	599-FR04
One-Pole Kit — Panel-Mounted (31...60 A Class J Fuse)	1491-R173
One-Pole Kit — Panel-Mounted (61...100 A Class J Fuse)	1491-R175

* For control circuit transformers with a 350 VA or larger rating, it is recommended that Bussmann Type FNQ-R, Ferraz-Shawmut Type ATDR, Littelfuse Type KLDR time delay fuses, or equivalent be used for primary fusing.

† These kits use only Class CC or Midget fuses (rated 0.5...30 A) such as those offered by the following manufacturers:

- Bussmann KTK-R
- Ferraz-Shawmut ATM R
- Littelfuse KLK

‡ Cat. No. 599-FR04 is rated for 6 A fuse maximum. Controller mounting applies to size 0...5 devices only.

Control Circuit Transformers

Approximate Dimensions and Shipping Weights

Approximate Dimensions

Dimensions are shown in inches (millimeters). Dimensions are not intended to be used for manufacturing purposes.

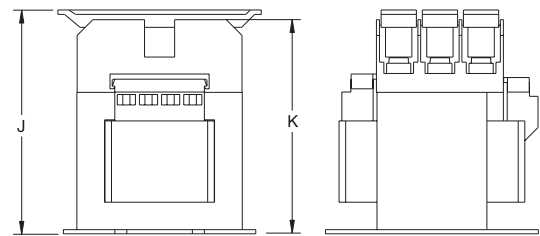
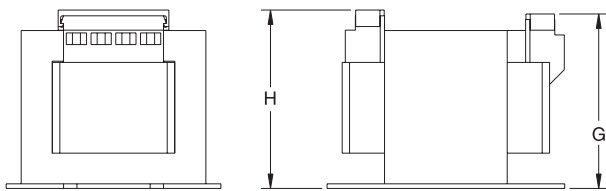
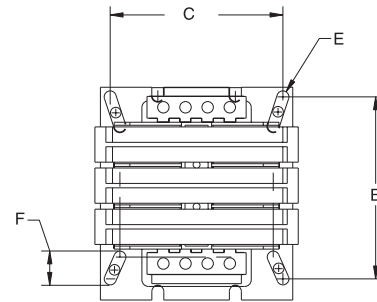
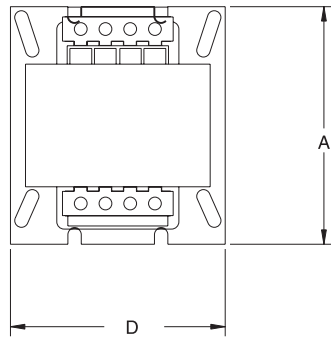

Transformer without Fusing

Transformer with Fuse Holder and Covers

VA	A	B	C	D	E	F	G	H	J	K	Approximate Shipping Wt. lbs (kg)	
											Without Top-Mounted Fuse Block	2-Pole Primary and 1-Pole Secondary Top-Mounted Fuse Block
63	3-7/8 (98.00)	3-1/4 (82.55)	3-1/8 (79.38)	3-1/2 (88.90)	7/32 (5.54)	22/32 (18.29)	2-27/32 (72.39)	2-3/8 (73.91)	4-5/64 (103.51)	3-57/64 (99.01)	4-1/2 (2.04)	4-4/5 (2.18)
80	3-7/8 (98.00)	3-1/4 (82.55)	3-1/8 (79.38)	3-1/2 (88.90)	7/32 (5.54)	22/32 (18.29)	2-27/32 (72.39)	2-3/8 (73.91)	4-5/64 (103.51)	3-57/64 (99.01)	4-1/2 (2.04)	4-4/5 (2.18)
130	3-7/8 (98.00)	3-1/4 (82.55)	3-1/8 (79.38)	3-1/2 (88.90)	7/32 (5.54)	22/32 (18.29)	3-3/8 (85.60)	3-13/32 (86.61)	4-45/64 (119.5)	4-35/64 (115.44)	6-7/10 (3.04)	7-3/20 (3.24)

Control Circuit Transformers

Approximate Dimensions and Shipping Weights, Continued

Dimensions are shown in inches (millimeters). Dimensions are not intended to be used for manufacturing purposes.

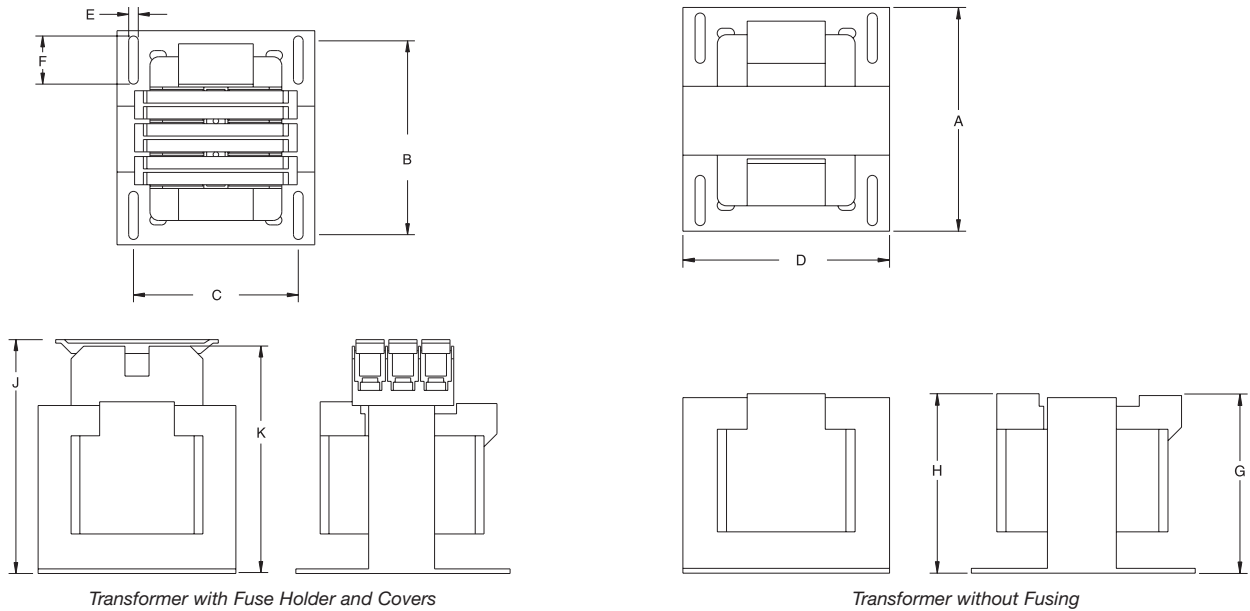

VA	A	B	C	D	E	F	G	H	J	K	Approximate Shipping Wt. lbs (kg)	
											Without Top-Mounted Fuse Block	2-Pole Primary and 1-Pole Secondary Top-Mounted Fuse Block
200	4-7/8 (123.95)	4-7/16 (112.78)	3-3/4 (95.25)	4-1/2 (114.30)	7/32 (5.59)	1-1/8 (28.70)	3-3/8 (85.60)	3-29/32 (86.61)	5-21/64 (135.26)	5-11/64 (131.44)	8-2/5 (3.81)	8-7/10 (3.95)
250	4-7/8 (123.95)	4-7/16 (108.20)	3-3/4 (95.25)	4-1/2 (114.30)	7/32 (5.59)	1-1/8 (28.70)	3-7/8 (98.30)	3-29/32 (98.30)	5-21/64 (135.26)	5-11/64 (131.44)	10-2/5 (4.72)	10-4/5 (4.90)
350	4-7/8 (123.95)	4-7/16 (108.20)	3-3/4 (95.25)	4-1/2 (114.30)	7/32 (5.59)	1-1/8 (28.70)	3-7/8 (98.30)	3-29/32 (98.30)	5-21/64 (135.26)	5-11/64 (131.44)	13-2/5 (6.08)	13-4/5 (6.26)

Control Circuit Transformers

Approximate Dimensions and Shipping Weights, Continued

Dimensions are shown in inches (millimeters). Dimensions are not intended to be used for manufacturing purposes.

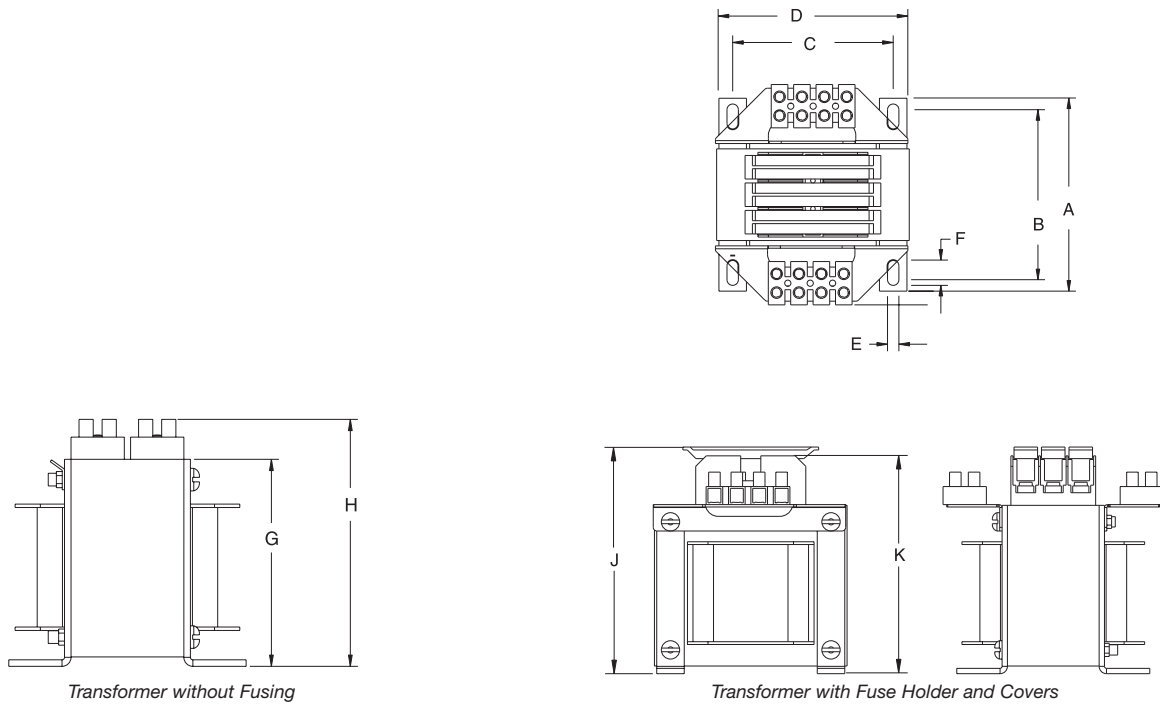

VA	A	B	C	D	E	F	G	H	J	K	Approximate Shipping Wt. lbs (kg)	
											Without Top-Mounted Fuse Block	2-Pole Primary and 1-Pole Secondary Top-Mounted Fuse Block
500	5-1/4 (133.35)	4-33/64 (114.81)	4-3/8 (111.25)	5-1/4 (133.35)	5/16 (7.87)	45/64 (18.03)	4-17/32 (114.81)	5-1/2 (139.70)	6-3/16 (156.97)	5-15/16 (150.62)	17-3/5 (7.98)	17-19/20 (8.14)

Control Circuit Transformers

Approximate Dimensions and Shipping Weights, Continued

Dimensions are shown in inches (millimeters). Dimensions are not intended to be used for manufacturing purposes.

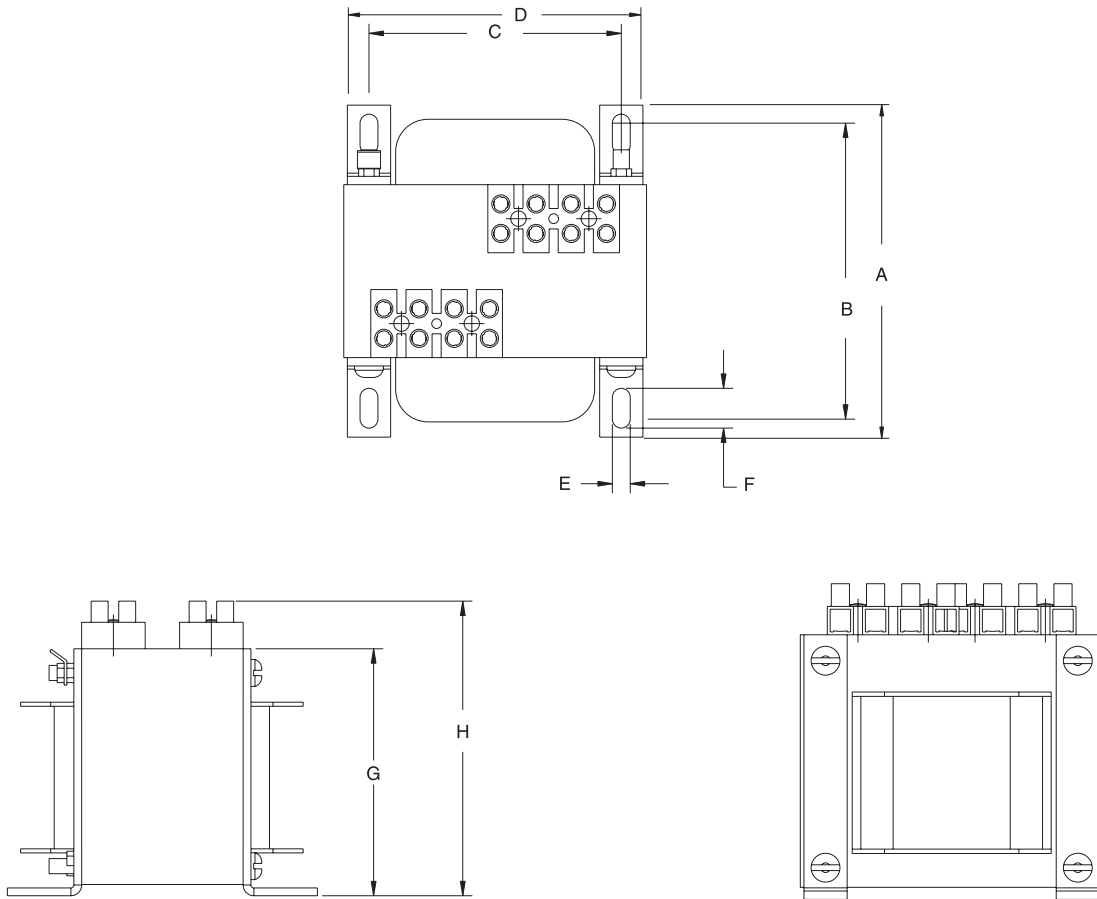

Transformer without Fusing

VA	A	B	C	D	E	F	G	H	Approximate Shipping Wt. lbs (kg)	
									Without Top-Mounted Fuse Block	2-Pole Primary and 1-Pole Secondary Top-Mounted Fuse Block
750	5-3/4 (146.05)	5 (127.51)	4-3/8 (111.25)	5-1/4 (133.35)	5/16 (7.87)	45/64 (18.03)	4-9/16 (114.81)	5-19/32 (137.41)	21-1/2 (9.75)	—
800	5-3/4 (146.05)	5 (127.51)	4-3/8 (111.25)	5-1/4 (133.35)	5/16 (7.87)	45/64 (18.03)	4-9/16 (114.81)	5-19/32 (137.41)	21-1/2 (9.75)	—

Control Circuit Transformers

Approximate Dimensions and Shipping Weights, Continued

Dimensions are shown in inches (millimeters). Dimensions are not intended to be used for manufacturing purposes.

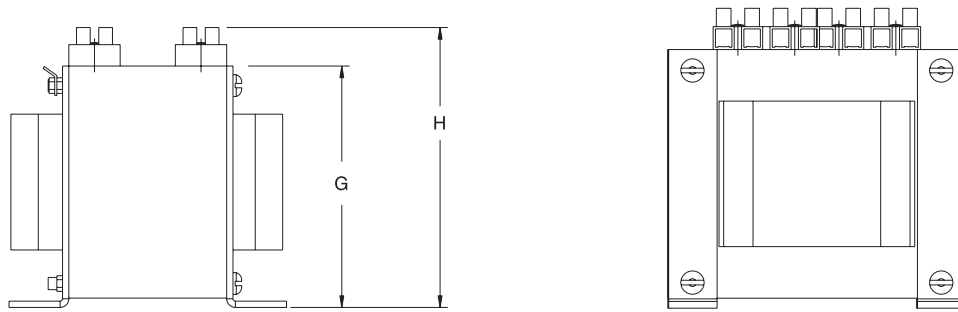
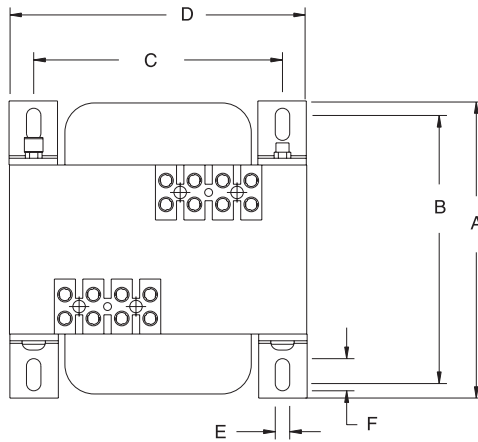

Transformer without Fusing

VA	A	B	C	D	E	F	G	H	Approximate Shipping Wt. lbs (kg)	
									Without Top-Mounted Fuse Block	2-Pole Primary and 1-Pole Secondary Top-Mounted Fuse Block
1000	6-3/8 (161.92)	5-3/8 (136.53)	5-5/16 (134.94)	6-3/8 (161.92)	5/16 (7.87)	45/64 (18.03)	5-33/64 (140.21)	6-1/2 (162.56)	37-1/5 (16.87)	—

Control Circuit Transformers

Approximate Dimensions and Shipping Weights, Continued

Dimensions are shown in inches (millimeters). Dimensions are not intended to be used for manufacturing purposes.

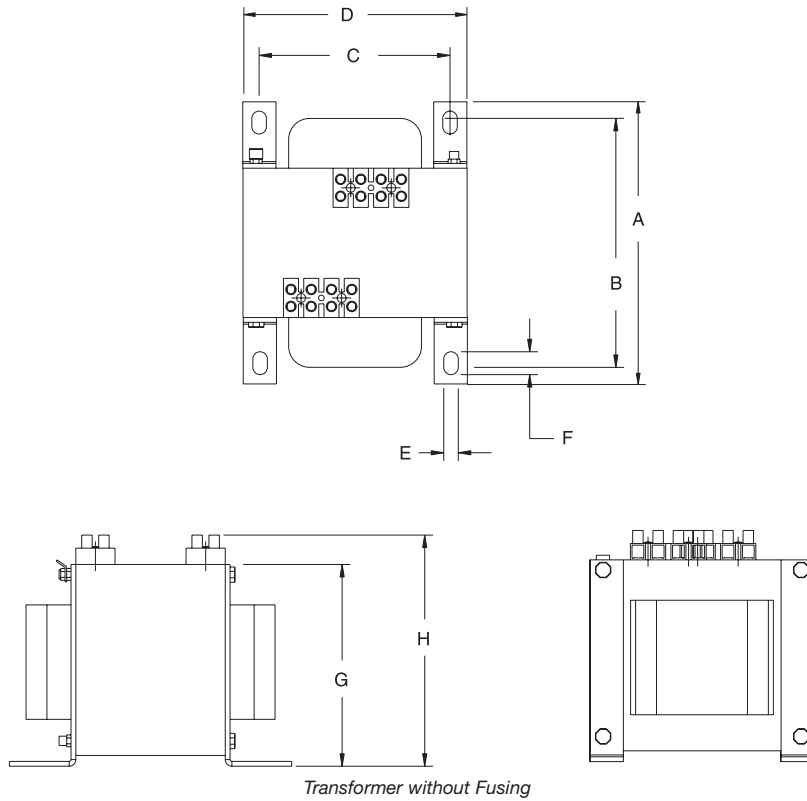

VA	A	B	C	D	E	F	G	H	Approximate Shipping Wt. lbs (kg)	
									Without Top-Mounted Fuse Block	2-Pole Primary and 1-Pole Secondary Top-Mounted Fuse Block
1600	8-1/2 (215.90)	7-1/4 (184.15)	5-3/4 (143.76)	6-3/4 (171.45)	7/16 (10.92)	45/64 (18.03)	5-3/4 (146.05)	7-1/16 (168.66)	50-4/5 (23.04)	—

Control Circuit Transformers

Approximate Dimensions and Shipping Weights, Continued

Dimensions are shown in inches (millimeters). Dimensions are not intended to be used for manufacturing purposes.

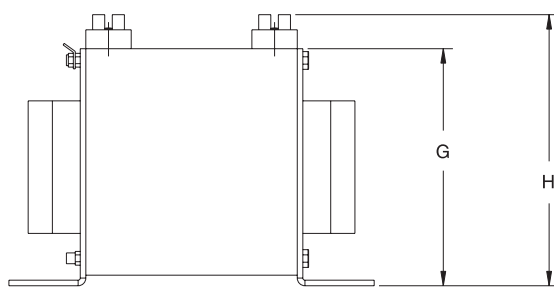
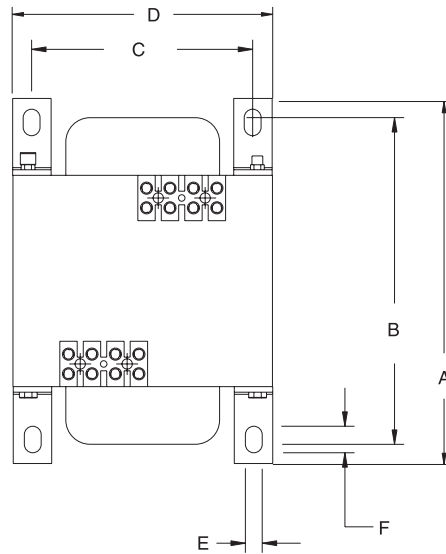

Transformer without Fusing

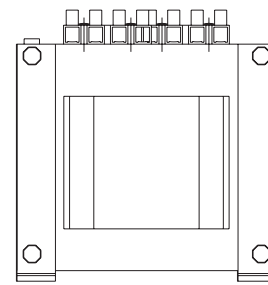

VA	A	B	C	D	E	F	G	H	Approximate Shipping Wt. lbs (kg)	
									Without Top-Mounted Fuse Block	2-Pole Primary and 1-Pole Secondary Top-Mounted Fuse Block
2000	9-1/2 (241.30)	8-1/4 (209.55)	5-3/4 (143.76)	6-3/4 (171.45)	7/16 (10.92)	45/64 (18.03)	5-11/64 (149.86)	7-1/16 (172.47)	61 (27.67)	—

Control Circuit Transformers

Approximate Dimensions and Shipping Weights, Continued

Dimensions are shown in inches (millimeters). Dimensions are not intended to be used for manufacturing purposes.

Note: Electrical clearance required to top of fuse block.

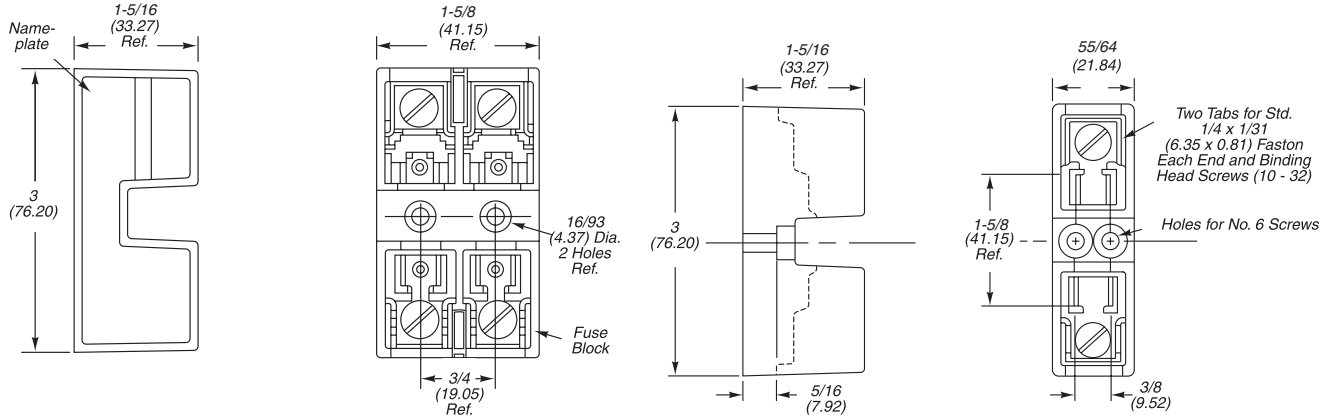

Cat. No. 1491-R162
Cat. No. 1491-R167

Cat. No. 1491-R165

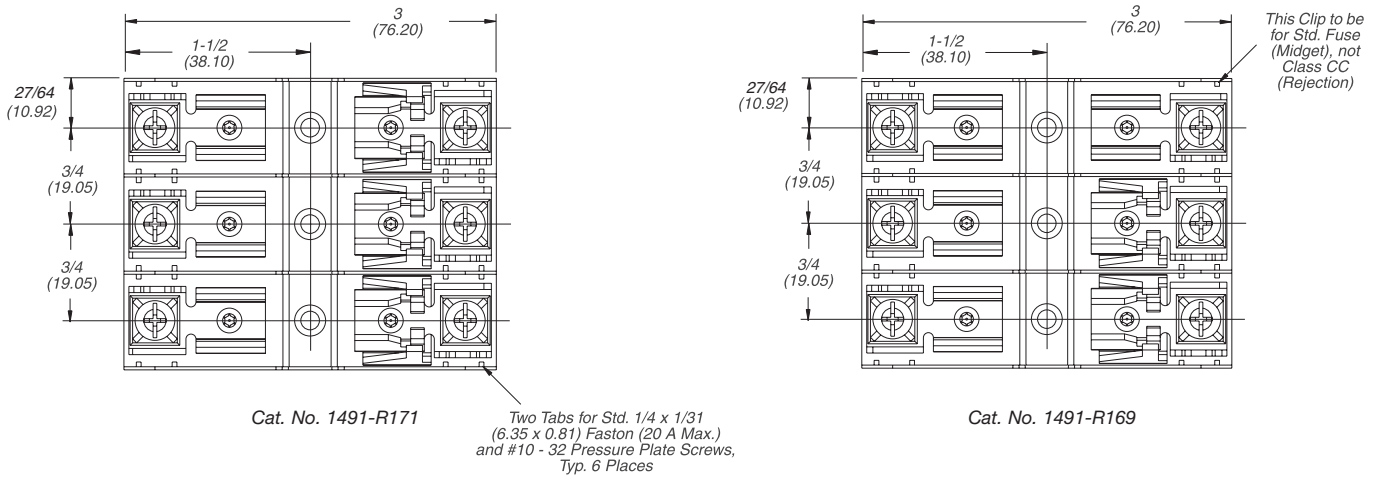

Cat. No. 1491-R171

Cat. No. 1491-R169

Two Tabs for Std. 1/4 x 1/31 (6.35 x 0.81) Faston (20 A Max.) and #10 - 32 Pressure Plate Screws, Typ. 6 Places

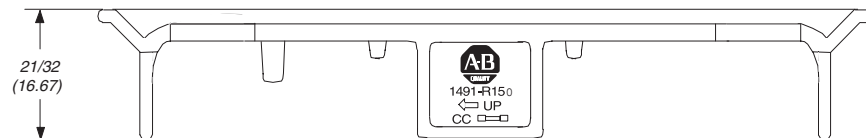
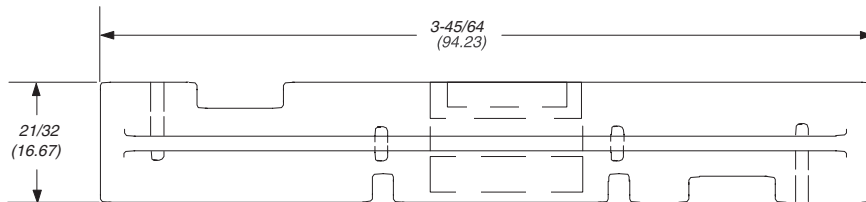
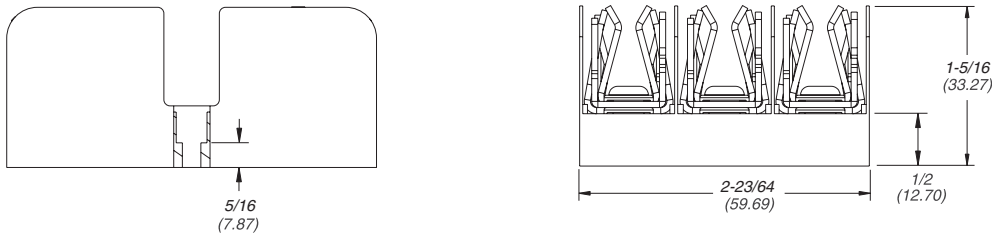

Cat. No. 1491-R150