

Perfect proportions

Balancing proportions – our desire to create optimum conditions for your processes.

Bioengineering equipment accommodates any type of process and at the same time satisfies your striving for an appropriate fusion of functional design and optimum size.

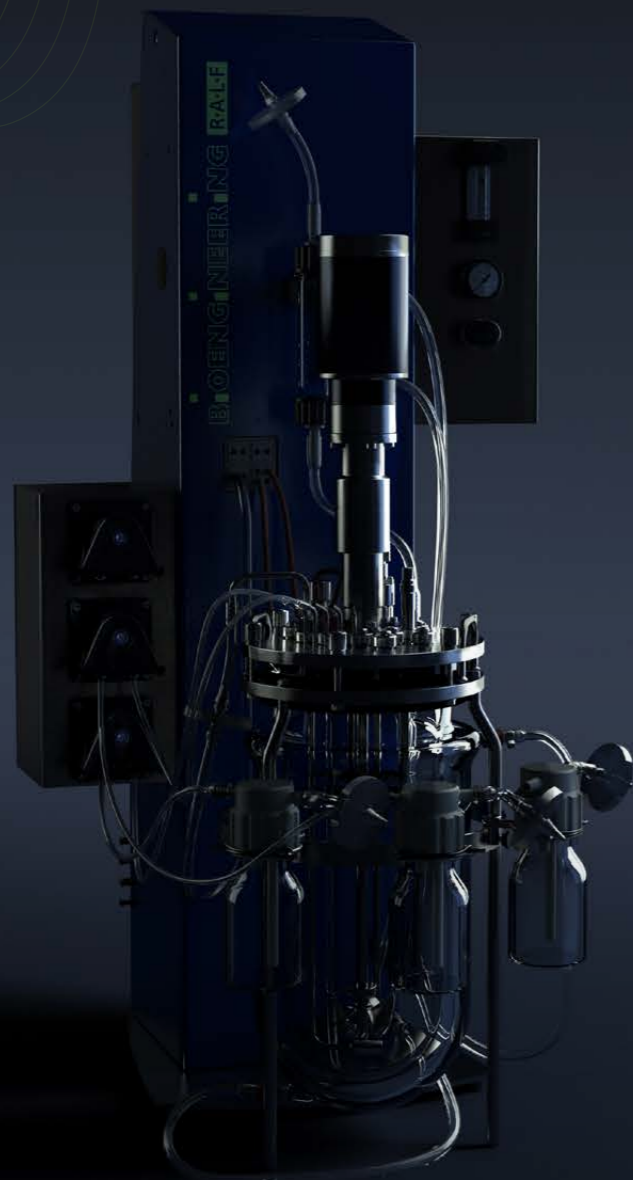

Bioengineering RALF requires little space – even in multi-unit configurations

Compact design

Our layout – with the vessel in front of the control tower and central connections for all probes/utilities – ensures accessibility from all sides, as well as a fast and easy set-up. A slim control tower with a small footprint minimizes the space requirements in your lab.



The vessel slims down for autoclaving

Collapsible reflux cooler

Thanks to flexible hose couplings, the reflux cooler is attached to the control tower during the fermentation process, but can quickly be detached and laterally positioned on the vessel wall for sterilization in an autoclave. This unique feature drastically reduces the total height of the vessel assembly needed for autoclaving.

Everything set in place

Vertically retractable handles reduce the required autoclave space. They also provide convenient access to lid ports during assembly and inoculation.

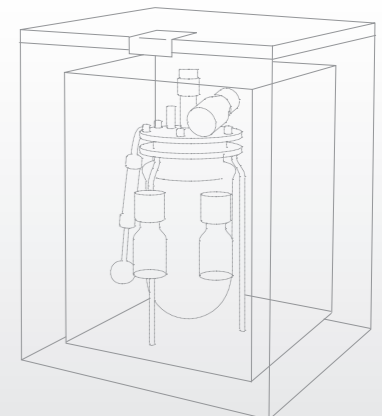
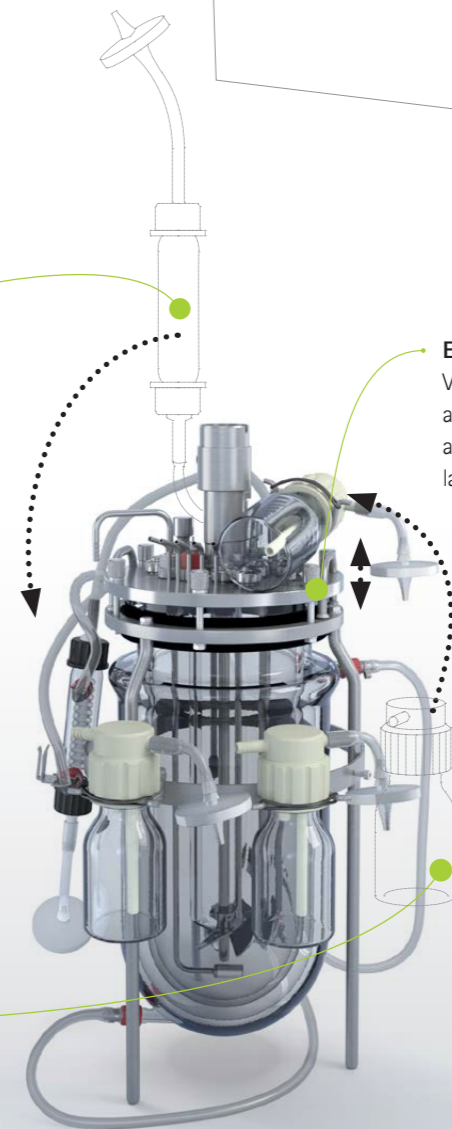

Flexible configuration

Autoclavable medium and feed bottles with filters can be clamped onto the vessel. If desired, they can easily be detached and repositioned anywhere else you see fit. This further reduces the space required in an autoclave.

Smart solutions

We take **S M A R T** literally – by every single letter.

The solutions we offer are **S**pecific, **M**easurable and **A**ccepted throughout the industry, as well as **R**easonable – well established and technically mature – and **T**ime-oriented: promptly delivered within the requested time frame.

Plug 'n' Play: Connectivity at your fingertips

Switch from microbial to cell cultivation and vice-versa

Due to its modular design and the wide variety of gas modules one can choose from, each Bioengineering RALF is capable of delivering both high and low vvm rates. Thus, the same bioreactor can be utilized for either microbial fermentation or cell cultivation.



Connections for multiple Bioengineering RALF systems

Using shared utility connections for multiple Bioengineering RALF systems (employing 2–6 units) requires less space and fewer utility requirements, while also providing an easier and faster means of assembly.

Three temperature control options

Hollow baffles

Our temperature control system achieves two-sided temperature control, but in a single-wall vessel. This leads to a shorter autoclave time and lower overall vessel costs, while providing highly uniform temperature distribution previously obtained only in double-jacket vessels.

Double-jacket vessel

For shear-sensitive processes, a heating loop combined with a double-jacket vessel assures uniform temperature distribution within the vessel, even for smaller working volumes.

Heating pad

An electric heating pad with cut-outs for observation, heats the vessel quickly and efficiently. Cooling is provided by a valve-controlled cooling finger.

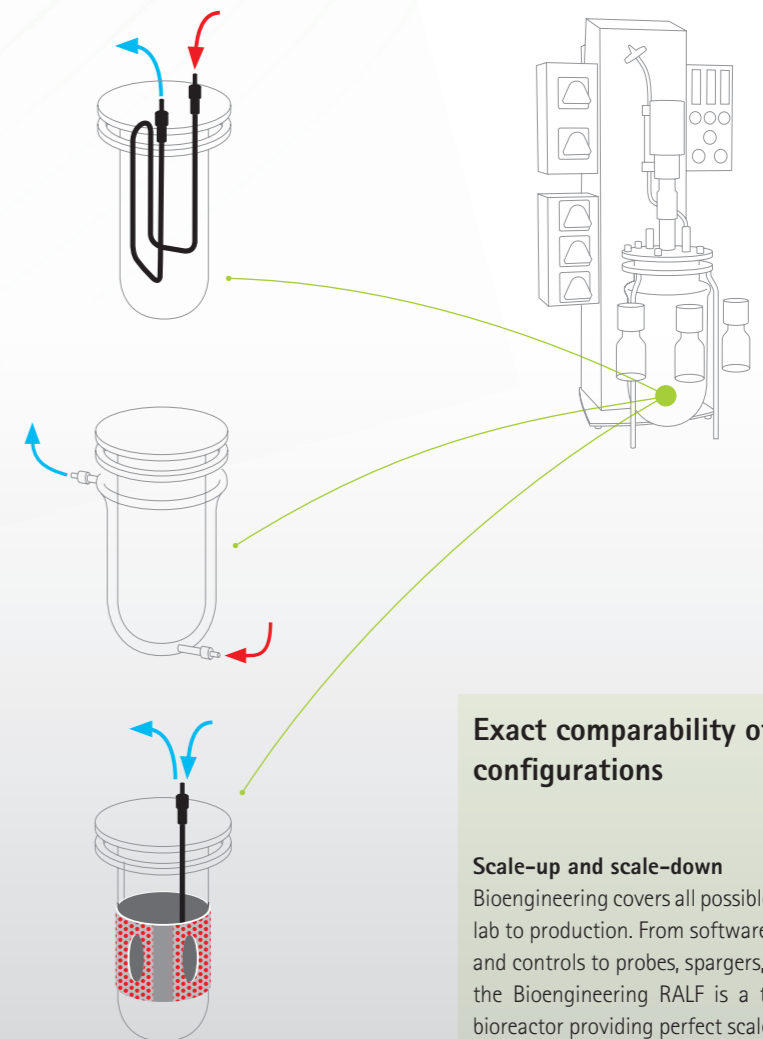

Exact comparability of configurations

Scale-up and scale-down

Bioengineering covers all possible demands from lab to production. From software, measurement, and controls to probes, spargers, and agitators – the Bioengineering RALF is a true production bioreactor providing perfect scale-up conditions.

Quality in detail

Your quality standards inspire us to go the extra mile. In accordance with the Swiss tradition of commitment to quality, our materials and manufacturing procedures are subject to strict quality control.

Premium Swiss workmanship ensures impeccable hygienic design



Welds

Only the highest hygienic design standards and superior materials are used, including clean precision welding and flawlessly designed connections and ports.



Gaskets and ports

Gap-free and hygienic sealing is assured by positioning O-ring gaskets close to the medium side. The form of the ports permits simple and reliable installation of lid components, even in limited space environments.

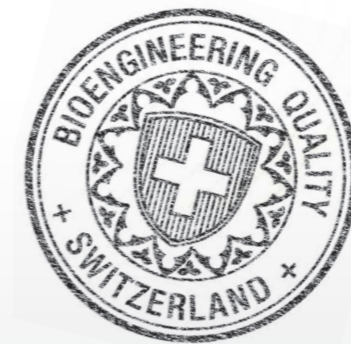

Bioengineering guarantees the best conditions from start to finish

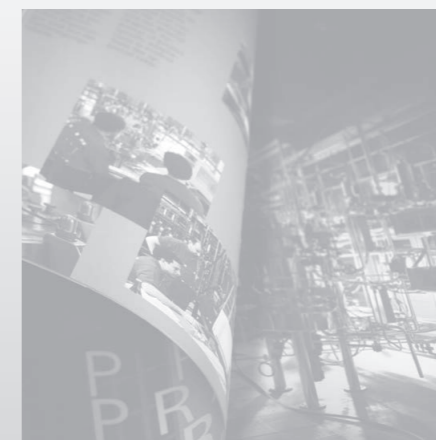

Engineering and manufacturing

Every Bioengineering RALF is carefully designed to the highest standards by our dedicated staff and subject to benchmark quality assurance. Each product arrives ready for use and promises optimal research conditions upon delivery.

Best-of-class suppliers

Our premium bioreactors use only the highest quality parts. Certified suppliers with decades of experience in bioprocess applications are carefully selected to maximize reliability and enhance the overall user experience.

Easy handling

Convenient interfaces allow simple removal of vessels

Drive

Our maintenance-free high-duty agitator has plug 'n' play coupling with the shaft. Set up and disassembly is completed in a mere matter of seconds.



Addition / transfer hoses

Bioengineering's unique pump head design enables users to simply and safely snap on and off their addition / transfer hoses, while couplings on both sides hold the hoses in place and prevent them from shifting.



Probes

Pluggable connections allow for the quick detachment of the wiring of probes. Since all of our plugs visually differ from one another, no confusion arises when connecting the vessel.



Temperature circuit

Quick-action, color-coded couplings provide an easy means to swiftly disconnect water loop hoses and prevent uncertainties when reconnecting the vessel.

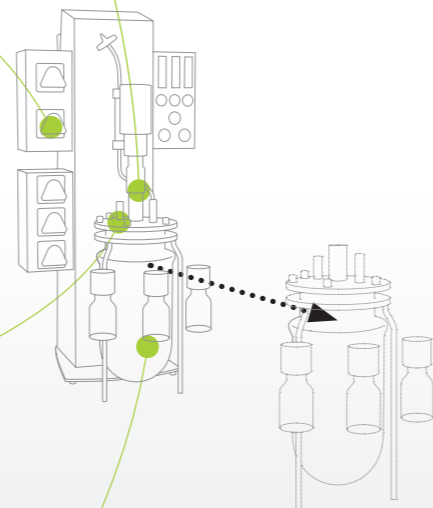

We put on our thinking cap to free your head for the job at hand.

Self-explanatory handling details allow you to focus all your attention on the process.

Immediate access to the control unit

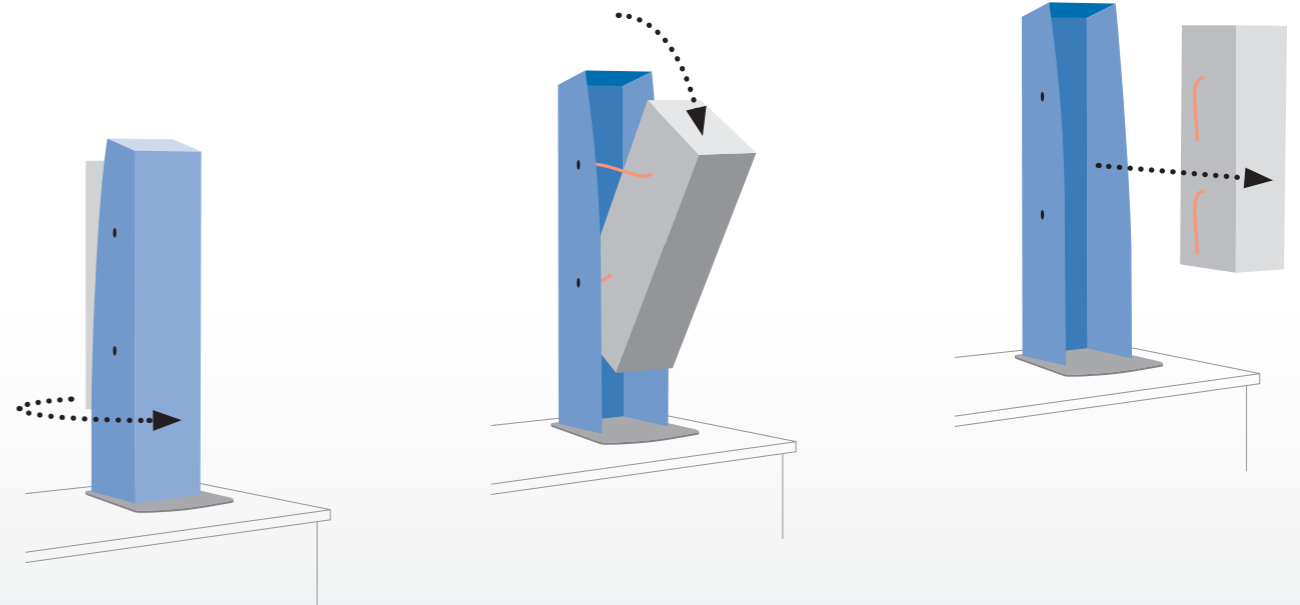

Rotate

The control unit's rotational capability of 180° on its pedestal involves minimal effort on the part of the user, while providing convenient access to all interfaces, valves, and other components.

Tilt forward

If required, the control unit can be tilted forward to access additional interfaces within the housing (for example when upgrading the Bioengineering RALF). The control unit is safely attached for risk-free work, even in the tilted position.

Remove

The control unit can be detached from the utility lines, removed from the housing, and, if necessary, replaced with a new unit – all within minutes.

Modular design

A wide range of modules offers you enough choice to match our equipment to your needs – optimally and from the first step.

Bioengineering RALF: Modular and yet individual

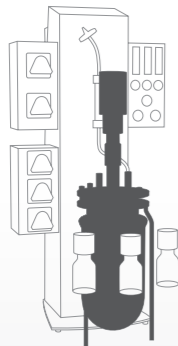

Vessel

The autoclavable glass vessel is featured with a hemispherical bottom and is available in single- or double-jacket versions. The stainless steel lid enables the hygienic connection of all probes, metered inlet/outlet piping, as well as all gas supply and exhaust lines. A high-performance,

maintenance-free motor, centrally positioned on the lid, covers a vast speed range and can drive height-adjustable impellers of various types. A hygienically designed mechanical seal or magnetic drive ensures that the vessel is completely sealed off and sterile.

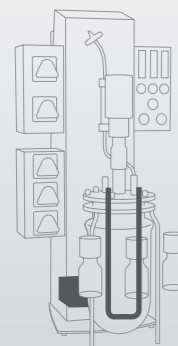

Temperature control

Multiple temperature control systems are available. They all evenly heat the reaction space and maintain the desired temperature with a high degree of accuracy. This can be done with a cooling finger in combination with a heating

pad. Alternatively, a water loop with a recirculation pump keeps the temperature constant via the double-jacket vessel or perfused baffles – all without obstructing the ability to view the reaction space.

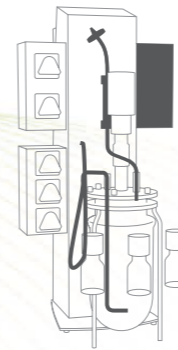

Aeration

Up to six gas lines can be combined for multiple aeration strategies. The wide choice of gas flow combinations provides you with the flexibility to deploy the same fermenter for microbial processes as well as for cell cultivation, if desired. The gas lines are laterally positioned on the side of the control unit in expandable or interchangeable modules. This allows you to control the flow rate and the pressure of the gas mixture injected into the process. Using solenoid valves or mass flow controllers, you can easily automate all gas lines and integrate them into

your control strategy. Several different options are available to assure optimized aeration for any culture: submerged and surface aeration, high-intensity aeration tubes, and spargers for minimized bubble sizes – even at low speeds. The exhaust gas flow is dehumidified in a reflux cooler before going through the exhaust filter. To analyze the O₂ and CO₂ concentrations in the exhaust stream, a Bioengineering Exhalizer can be integrated into the system at any time without additional software modifications.

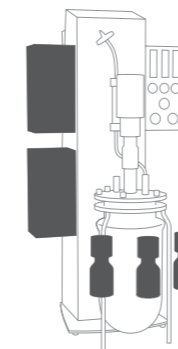

Addition / transfer

Up to seven peristaltic pumps guarantee the precise, minimally pulsed delivery of medium and correction fluids, such as acids, alkalis, or antifoaming agents from ancillary glass flasks. Also included is the extraction and transfer of culture fluids from the vessel. The fixed- or variable-speed pumps are integrated into modules that are mounted on the side of the control unit and can be combined in various ways. For a particularly wide range of flow rates and

accurately controlled speeds, an extra free-standing pump with local display and operating elements can be added to the configuration. This is useful for highly accurate continuous or profile-dependent metering. It is also possible to assign all pumps freely to various control loops and change their tag in the software, optimally addressing process requirements related to corrective agents and nutrients.

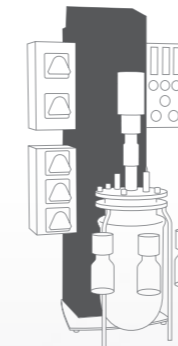

Control unit

Each Bioengineering RALF is equipped with basic control loops that can be expanded, depending on your needs for additional measurements and functions.

Aside from speed, temperature, pH, pO₂, level, or foam controllers, you can add an I/O module with universal controllers for measuring O₂ and CO₂ concentrations in the exhaust stream, the redox potential, or alcohol concentrations. The simple plug-in connection for scales of all capacities enables precise feeding or chemostat cultivation if desired.

The interfaces of the control unit are accessible via plug connectors, and the control software is designed to accommodate additional parameters. This allows you to broaden the scope of functionality at any time with plug 'n' play simplicity.

Connections for analog and digital valves or switches are available as well. Together with the control software, these features support the swift and flexible configuration of control loops correlating internal or external measuring points, valves, pumps, or even subordinate controllers.

The BioSCADA RALF software has a user-friendly interface which permits fast and direct access to the process, including comprehensive analyses, documentation, and management of all current and historic process data. Further features of the software include online export of open process data to Excel and the generation of readily available batch reports. Furthermore, the definition of sequential algorithms and recipes without programming skills are part of the functions, along with alarm and user authorization level management.

Full access to the individual controllers is provided via easy-to-handle input and display fields. With these fields, you can preset control parameters, specify alarm thresholds, diagnose and calibrate probes, and define cascades and profiles. The media and variables displayed on the graphical user interface can be named according to your preferences. The consumption of all correction media is also accessible with the BioSCADA RALF software.

Various additional options

Our options bear witness to the wide scope of our systems and offer optimum upgrades for your equipment, any time.

Individualize your Bioengineering RALF!



Vessel options

Multiple interchangeable mixing elements – such as Rushton, marine and pitched blade impellers – enable high flexibility for optimized mixing.



Addition / transfer options

Fermenters can be equipped with different addition / transfer systems, such as a perfusion filter. The result is the efficient cultivation of different cell cultures, as well as a wide range of microorganisms.



Control unit options

Conveniently expand the scope of your functionality by simple plug 'n' play for a large variety of external devices.



Aeration options

Choose from multiple aeration systems for the best possible and most efficient aeration strategy necessary for different microorganisms and cell cultures.

Upgrade kits



Aeration upgrade kits

Advanced products permit any combination of up to six gases, with a vast range of flow rates. Should process requirements change, you can easily upgrade or replace gas modules at a later stage.



Addition / transfer upgrade kits

Pump upgrade kits enable easy upgrade of addition / transfer capabilities (these connect up to seven pumps which can be added on later).



Vessel kits

Users are completely free to configure their vessel kit, which can be used as a backup vessel, or to avoid downtime during autoclaving.

For more detailed information, please refer to «Module Options».

Full control – ingenious but easy

With us, you don't need to be a control freak to have everything under control.

Our process automation allows for optimum process flow thanks to top-grade measuring and control units, in conjunction with easy-to-handle bioprocess management software that lets you monitor and record everything according to your choice.



Automation

BioSCADA RALF is based on our proven BioSCADA software, which was designed to meet today's challenging demands for laboratory and production systems around the world.

This outstanding BioSCADA system incorporates the cumulative experience acquired over years of development from end-users and partners in all fields of operation. It guarantees you the best link between scale-up and scale-down, as well as advantages in operator training, usability, and maintenance.

Bioengineering BioSCADA RALF and supervisory control

- Each Bioengineering RALF comes with BioSCADA RALF, the most comprehensive and intuitive bioprocess management software on the market. Whether your process is simple or sophisticated, BioSCADA RALF will always adapt to your requirements.
- BioSCADA RALF permits full process automation – including advanced recipe functions, batch recording, user management, audit trail, report generation, as well as other key features to meet the high demands of the 24/7 industry environment. It requires no previous bioprocess software or programming knowledge whatsoever to use successfully.
- Multiple built-in analysis options give you a perfect overview of your process and the ability to export your data into any given format.
- BioSCADA RALF allows total connectivity: add, calibrate, name, and access external devices to use them as inputs or outputs in your control strategy.

Most reliable and durable probes from best-in-class suppliers

- We use solely the best and most advanced probes on the market. It goes without saying that easy recalibration, the ability to run probe diagnostics with software, and extended longevity are our standard for this critical piece of the bioreactor.

Hardware control loops

- Each control loop is independently managed in the hardware of Bioengineering RALF, meaning that setpoints are saved in the actual controllers and not just in the software.

Free input and output for external devices – such as scales, Exhalzers, VOC, probes etc.

- The I/O package also includes multiple, free digital and analog inputs/outputs. Via standard input/output signals, connect external devices such as scales, additional probes, Exhalzers for CO₂/O₂ concentration analysis, or any other tool able to communicate with the Bioengineering RALF universal controller.

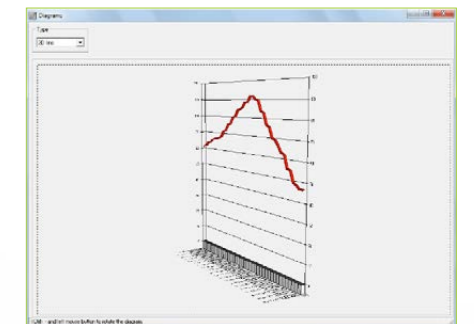
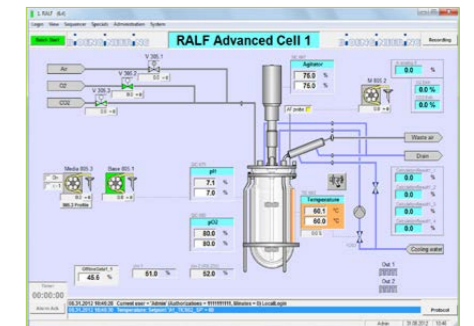

Expert customer service

Our professional customer support is part of the package.

Put your trust in us and expect fast, expert and efficient service and support.

Service

After-sales and spare parts services

- Our after-sales specialists provide a variety of support services – including commissioning, training, first level support, emergency repair, and spare parts.
- We guarantee prompt delivery of spare parts, available in stock at nearby locations. Our multilingual staff has in-depth knowledge of all of our products and services and is always happy to help you.

Local support

- With over 40 years of experience, installations in over 70 countries, and over 100 authorized representatives worldwide, Bioengineering backs up our professional equipment with fast and personal customer support.
- With several locations established around the world and covering every time zone, we will be there for you when you need us.

Installation

- Every Bioengineering RALF comes with a straightforward, but comprehensive, installation guide and user manual. We offer installation and training packages to help instruct your team and successfully get you started using your Bioengineering RALF system to its full potential from day one.
- Contact your local representative to find out what is available in your area.