

Proportional Flow-Control Cartridges, Size 5

$Q_{max} = 22 \text{ l/min}$, $p_{max} = 250 \text{ bar}$, $Q_N = 20 \text{ l/min}$ at $\Delta p 20 \text{ bar}$
 Leak free, load compensated, two stage
 Series MVRPLSA-...



- Seat-valve shut-off from 2 → 1
- Load-independent flow rate
- Normally closed
- Multifunction cartridge with compact design for Bucher standard cavity type AY
- Reliable operation over the whole pressure and flow range (even with high pressure differentials)
- All external parts zinc plated, passivated (CrVI-free)
- High pressure wet-armature solenoids
- The slip-on coil can be rotated, and it can be replaced without opening the hydraulic envelope
- Various plug-connector systems and voltages are available
- Can be fitted in a line-mounting body

1 Description

Series MVRPLSA... two-stage proportional flow-control cartridges are size 5, leak-free, load-compensated screw-in valves with an M22 x 1.5 mounting thread. The ingenious principle makes it possible to combine several functions in one valve. The leak-free nature is preserved thanks to the innovative design, which shuts off the main and pilot functions simultaneously and with zero leakage, while the integral pressure-compensator function enables responsive, controlled and load-independent lowering. With these flow-control cartridges, the flow rate from 2 → 1 can be proportionally controlled without load dependency and it is continuously variable and can be set at any desired level. Due to their responsive opening and closing characteristics,

these cartridges are suitable for the smooth control of movement operations in mobile and industrial applications. This is required in lifting equipment, for example, to be able to move loads of all kinds with control and accuracy. The superior leak-free shut-off means that a raised load can be held in position with slight lowering movement. All external parts of the cartridge are zinc plated and passivated (CrVI-free) and are thus suitable for use in the harshest operating environments. The slip-on coils can be replaced without opening the hydraulic envelope and can be positioned at any angle through 360°. If you intend to manufacture your own cavities or are designing a line-mounting installation, please refer to the section "Related data sheets".

2 Symbol

Simplified

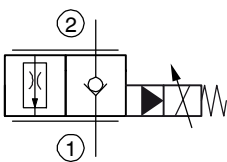

Detailed

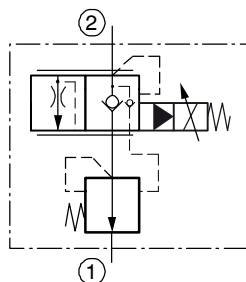

3 Technical data

General characteristics	Description, value, unit
Designation	proportional flow-control cartridge
Design	leak free, load compensated, two stage
Mounting method	screw-in cartridge M22 x 1.5
Tightening torque	50 Nm ± 10 %

General characteristics	Description, value, unit
Size	nominal size 5 mm, cavity type AY
Weight	0.38 kg
Mounting attitude	unrestricted (preferably vertical, coil down)
Ambient temperature range	-25 °C ... +50 °C

Hydraulic characteristics	Description, value, unit
Maximum operating pressure	250 bar
Maximum flow rate	22 l/min
Nominal flow rate	20 l/min at $\Delta p \geq 20$ bar
Leakage flow rate	< 0,2 cm ³ /min (max. 5 drops/min) with oil viscosity 33 mm ² /s (cSt)
Flow direction	2 → 1 flow control function, see symbols 1 → 2 free flow
Hydraulic fluid	HL and HLP mineral oil to DIN 51 524; for other fluids, please contact BUCHER
Hydraulic fluid temperature range	-25 °C ... +70 °C
Viscosity range	15...380 mm ² /s (cSt), recommended 20...130 mm ² /s (cSt)
Minimum fluid cleanliness Cleanliness class to ISO 4406 : 1999	class 18/16/13

Electrical characteristics	Description, value, unit
Supply voltage	12 V DC, 24 V DC
Control current	12 V = 0... 1400 mA, 24 V = 0... 760 mA
Power consumption at max. control current	max. 19 W
Coil resistance R - cold value at 20 °C - max. warm value	12 V = 5.8 Ω / 24 V = 21 Ω 12 V = 8.6 Ω / 24 V = 32 Ω
Recommended PWM frequency (dither)	150 Hz
Hysteresis with PWM	4...8 % I _N
Reversal error with PWM	4...8 % I _N
Sensitivity with PWM	< 4 % I _N
Reproducibility with PWM	< 2 % p _N
Relative duty cycle	100 %
Protection class to EN 60 529	IP 65 / IP 67 / IP 69K, see "Ordering code" (with appropriate mating connector and proper fitting and sealing)
Electrical connection	3-pin square plug to ISO 4400 / DIN 43 650 (standard) for other connectors, see "Ordering code"

4 Performance graphs

measured with oil viscosity 33 mm²/s (cSt)

$Q = f(I; \Delta p)$ Flow rate adjustment characteristic

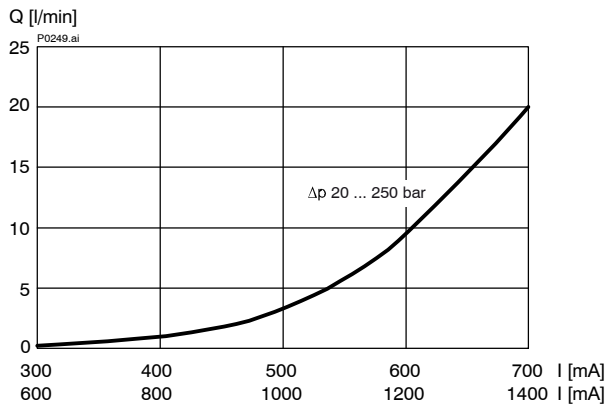

$Q = f(\Delta p; I)$ Flow rate adjustment characteristic

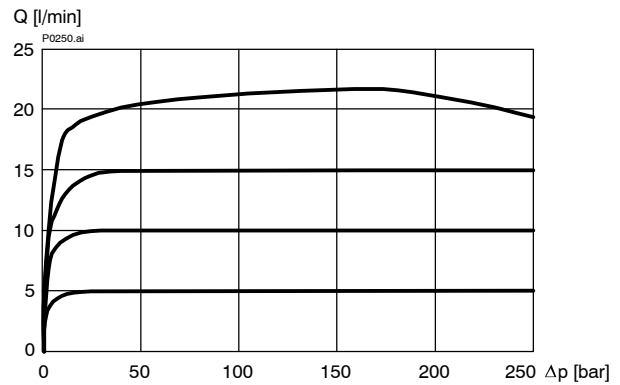

$\Delta p = f(Q)$ Pressure drop - Flow rate characteristic
[2 → 1]

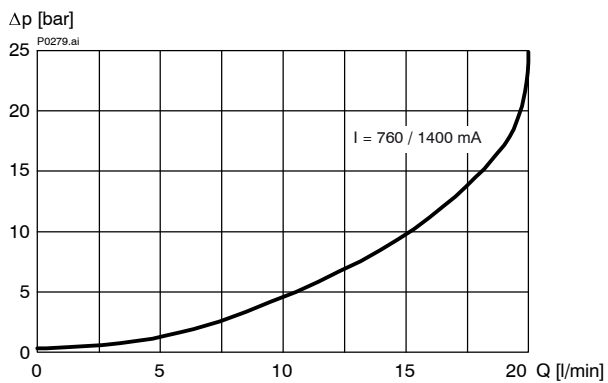

$\Delta p = f(Q)$ Pressure drop - Flow rate characteristic
[1 → 2]

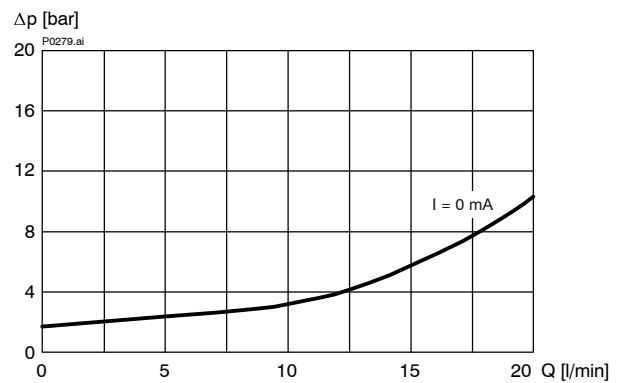

Attention:

where there are large pressure differences in the flow direction 1 → 2, the main stage poppet will become damaged.

5 Dimensions & sectional view

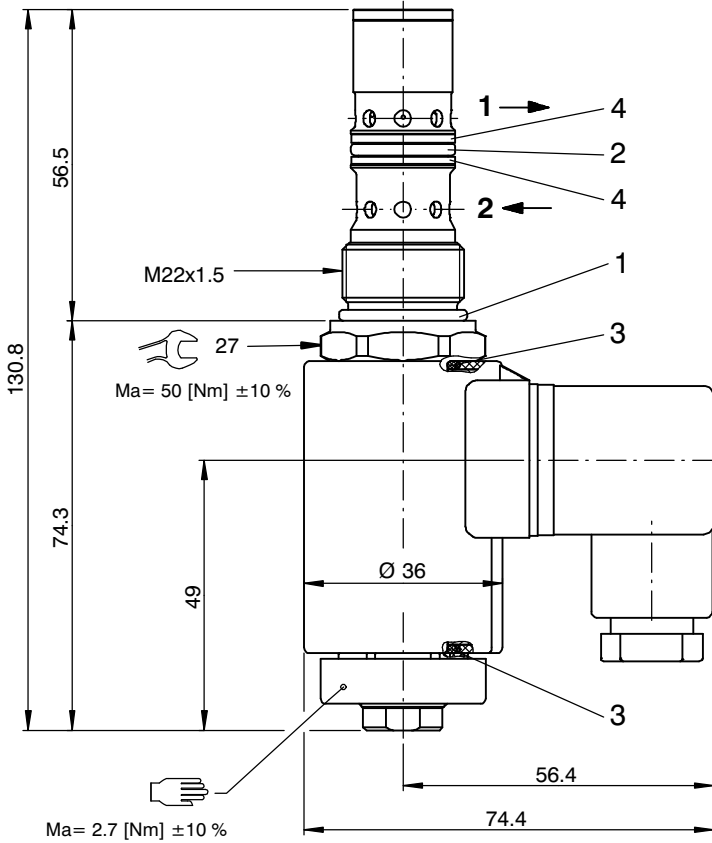

6 Application examples

- Lowering movements for industrial trucks that require a load-independent function with zero leakage
- Forklift trucks, lift platforms, etc.

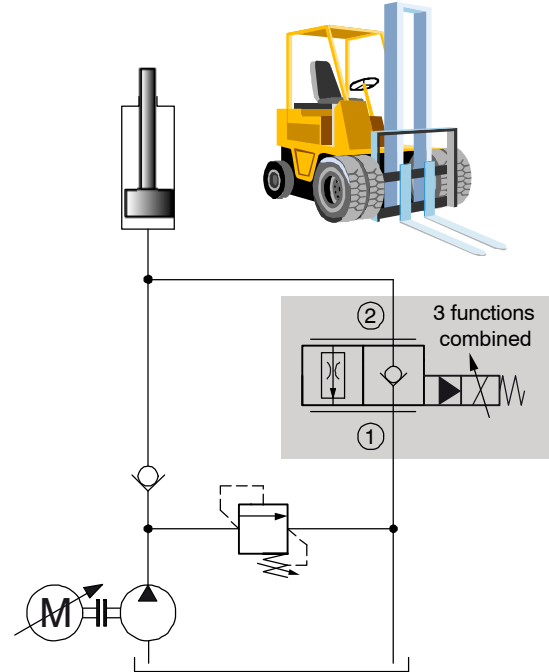

7 Installation information



IMPORTANT!

To achieve the proportional flow control cartridge maximum performance rating, fit the solenoid coil as shown (with the plug pins at the top). When fitting the cartridges, note the mounting attitude (preferably vertical, with coil down → automatic air bleed) and use the specified tightening torque. No adjustments are necessary, since the cartridges are set in the factory.



ATTENTION!

Only qualified personnel with mechanical skills may carry out any maintenance work. Generally, the only work that should ever be undertaken is to check, and possibly replace, the seals. When changing seals, oil or grease the new seals thoroughly before fitting them.

Seal kit NBR no. DS-406-N ¹⁾

Item	Qty.	Description
1	1	O-ring no. 019 Ø 20,35 x 1,78 N90
2	1	O-ring no. 016 Ø 15,60 x 1,78 N90
3	2	O-ring Ø 16,00 x 2,00 FKM
4	2	Backup ring Ø 14,90 x 1,40 x 1,40 F10751



IMPORTANT!

- ¹⁾ Seal kit with FKM (Viton) seals, no. DS-406-V

8 Ordering code

	MV	R	P	L	S	A	-	G	-	5	-	20	-		-	1		24	D	-	
M V	=	flow-control valve, two-stage																			
R	=	proportional-solenoid operated																			
P	=	cartridge design																			
L	=	load compensated																			
S	=	seat-valve design																			
A ... Q	=	standard model - see relevant data sheets																			
Z ... R	=	special features - please consult BUCHER																			
G	=	normally closed																			
5	=	nominal size 5 mm																			
20	=	nominal flow rate 20 l/min at $\Delta p \geq 20$ bar																			
(blank)	=	NBR (Nitrile) seals (standard)																			
V	=	FKM (Viton) seals (special seals - please contact BUCHER)																			
1 ... 9	=	design stage (omit when ordering new units)																			
...	=	voltage e.g. 24 (24 V)																			
D	=	current DC																			
(blank)	=	ISO 4400 / DIN 43 650 mating plug (standard, IP 65)																			
M100	=	without mating DIN plug																			
C	=	Kostal plug connection (IP 65)																			} mating plug not supplied
JT	=	Junior Timer radial plug connection (with protection diode, IP65)																			
IT	=	Junior Timer axial plug connection (with protection diode, IP65)																			
D	=	Deutsch plug connection DT04-2P (IP 67/69K)																			
DT	=	Deutsch plug connection DT04-2P (with protection diode, IP 67/69K)																			
F	=	flying leads (500 mm)																			

9 Related data sheets

Reference	(Old no.)	Description
400-P-040011	(i-32)	The form-tool hire programme
400-P-040271		Cavity type AY to Bucher standard
400-P-720231		Line-mounting body, type GAYA (G 3/8")

info.ch@bucherhydraulics.com

www.bucherhydraulics.com

© 2012 by Bucher Hydraulics AG Frutigen, CH-3714 Frutigen

All rights reserved.

Data is provided for the purpose of product description only, and must not be construed as warranted characteristics in the legal sense. The information does not relieve users from the duty of conducting their own evaluations and tests. Because the products are subject to continual improvement, we reserve the right to amend the product specifications contained in this catalogue.

Classification: 430.310.330.305.310.310