



Epsilon EP

Compact Servo Drives for Industrial Applications

2.2 A - 16 A
115 V | 230 V



CONTROL TECHNIQUES™

Nidec
All for dreams

Compact, Powerful and Easy-to-Use Servo Drives

The **Epsilon EP** is a compact, easy-to-use servo drive that is scalable from serving as a simple amplifier to a completely programmable 1.5 axis motion controller. Available in Base, Indexer and Programming variants to meet a broad variety of application requirements, the Epsilon EP has models configured with fieldbus options and motion control capabilities that provide an excellent value for your motion control dollar.

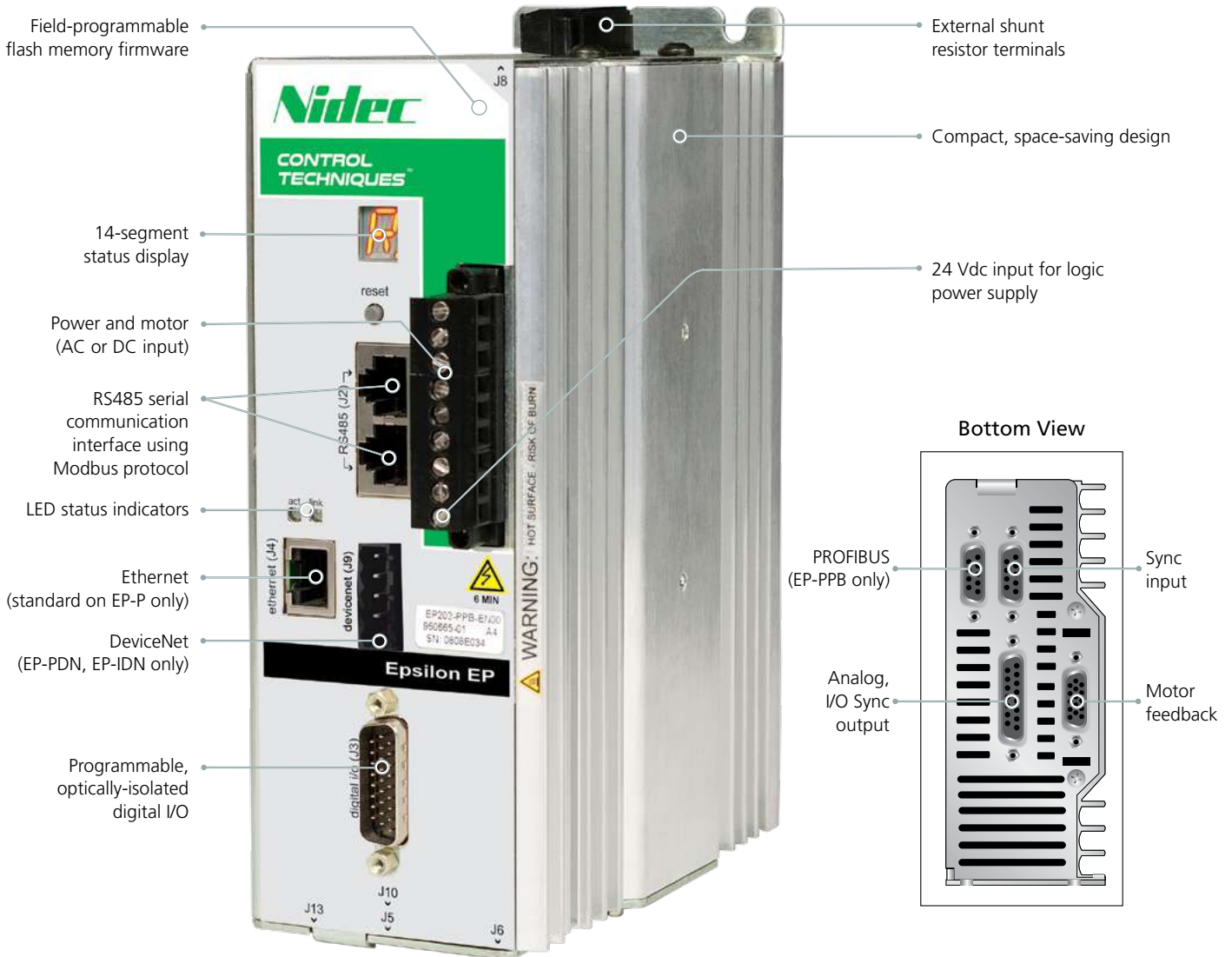

RoHS*
Compliant
*RoHS-compatible models are available.



Rugged, Reliable Motion Control

Good Things Come in Small Packages

Designed to fit in cabinets as small as six inches (152 mm) deep (with cables attached), the Epsilon EP series is the most compact digital servo drive in the Control Techniques product lineup. Though small in size, Epsilon EP drives possess the same rugged quality and reliability found in our larger drive series. There are five sizes of each Epsilon EP drive: 2.2, 4, 6.5, 9 and 16 A. The largest drive is capable of delivering up to 198 lb-in (22.4 Nm) continuous torque at rated motor speed. Each drive contains a 14-segment status display, reset button, removable connectors and utilizes standard “D-type” connectors. A wide range of options are available allowing the user to customize the Epsilon EP variants to meet application requirements.

Performance Advantage

Three configurations are available with built-in functionality (no add-ons required):

- **EP-B Base** — simple, for centralized control
- **EP-I Indexing** — point-to-point positioning applications
- **EP-P Programming** — sophisticated control

EP-B Base: Multiple Operating Modes

Modes include Analog Torque, Analog Velocity, Position Tracker® – Analog, Preset Velocity, Preset Velocity + Analog Velocity, Pulse/Pulse, Pulse/Direction and Pulse/Quadrature.

EP-I Indexing: Simple, Powerful Capabilities

Sixteen indexes with chaining and linking capability, jogging, a multitude of homing routines, user units and Position Tracker® (see page 5).

EP-P Programming: Provides Advanced Capabilities

Complex control is easily achieved in the Epsilon EP-P programming environment including Position Tracker® fieldbus indexing. Online help, application notes and programming examples are readily available. Capable of 1.5-axis control. Optional EP-PDN (DeviceNet), or EP-PPB (PROFIBUS DP) are also available.

Complimentary “Motion Made Easy”® Software

Control Techniques’ PowerTools Pro software uses drag-and-drop, fill-in-the-blank, point-and-click set-up, tabbed set-up screens and hierarchical views.

Extensive Motors, Cables and Options

FM, HD, NT and XV servo motors offer a wide range of inertia, torque, speed and cost; Pre-configured cables for easy installation.

Easy-to-Use Communications

Systems include Modbus RTU (standard), EtherNet/IP, Modbus TCP/IP, PROFIBUS DP and DeviceNet.

Modbus Master

Supplements RTU the drive’s on-board I/O, manages a very large number of I/O and communicates updates to any Modbus follower device.

Position Tracker®

Analog and fieldbus position control brings low-cost closed-loop feature onboard the drive. “Teach” function reduces set-up time.

Timers

Up to eight different timer types to match your needs.

Ethernet Programming

Epsilon EP-P drive uses common Ethernet protocols for all levels of networking.

Epsilon EP Product Overview		
Motors Controlled	Servo motors, linear motors, linear actuators, gear motors	
Control Modes	Analog Velocity, Analog Torque, Digital Velocity Preset, Summation of A/D Velocity, Pulse/Pulse, Pulse/Direction, and Pulse /Quadrature. Indexing and programmable positioning, analog positioning - Position Tracker®	
Continuous Torque	Up to 200 lb-in	
Continuous Current	2.2 A, 4 A, 6.5 A, 9 A & 16 A	
AC voltage 50/60 Hz ±10%	90 to 264 Vac 1 Ø 208 to 240 Vac 3 Ø (Epsilon EP 216 only)	
Motor Position Feedback	Incremental encoders	
Input/Output	Input	Output
Digital: Indexer, Programmable	16	8
Digital: Base	5	3
Analog:	1	2
Pulse Single-Ended	1	--
Pulse Differential	1	1
Input/Output Options	Via on-board MODBUS RTU master (EP-P)	
Communication	MODBUS RTU standard all models	
	EP-I: Optional DeviceNet - EP-IDN	
	EP-P: Modbus TCP/IP & EtherNet/IP std.	
	Optional: PROFIBUS DP (EP-PPB), DeviceNet (EP-PDN)	
Configuration & Programming	PowerTools Pro	
Approvals	UL, cULus, RoHS (option), CE	

Select the Epsilon EP That Meets Your Needs

Application Solutions from Simple to Complex

Three functional configurations are available to meet a wide variety of applications.



Base: Epsilon EP-B

This base drive is ideal for servo applications utilizing an external motion controller. It accepts an analog command signal and transmits position feedback. The EP-B has the unique capability of combining an analog command with a preset velocity for trimming or advance/ decel operations. The EP-B drive is an excellent choice for stepper replacements or centralized control systems.

Indexer: Epsilon EP-I or EP-IDN (DeviceNet)

The EP-I drive is a highly capable position controller that provides Home, Index and Jog motion profiles. The EP-I holds up to 16 unique indexes that also can be chained together to create complex motion profiles. The EP-I has a unique alternate mode feature whereby it can perform an Index or Home function and then switch to an alternate control mode (such as analog torque, analog velocity, or pulse-follower mode) on-the-fly.

Programming: Epsilon EP-P, EP-PDN (DeviceNet) and EP-PPB (PROFIBUS DP)

The EP-P drive provides the highest level of control by allowing the user to create complete user programs to sequence the motion control along with other machine functionality. Using Control Techniques' complimentary PowerTools Pro configuration software, the EP-P can be used to solve the most complex motion applications and simplify set-up using simple drag-and-drop and fill-in-the-blank screens. Set the EP-P to be a Modbus RTU master in order to control multiple combinations of EP-P, EP-B and EP-I drives, up to a total of 32 drives.

Epsilon EP Feature Matrix	Epsilon Model		
	EP-B	EP-I	EP-P
Velocity Summation	✓		✓
Analog Position	✓	✓	✓
Analog Velocity	✓	✓	✓
Pulse Follower	✓	✓	✓
Analog Torque	✓	✓	✓
Preset Velocity / Jog	✓	✓	✓
Torque Limits	✓	✓	✓
Software Travel Limits		✓	✓
Homing		✓	✓
Indexing		✓	✓
Index Chaining		✓	✓
Compound Indexing		✓	✓
Synchronized Motion			✓
Gearing			✓
Camming			✓
Timed Index			✓
Multiple Profile Summation			✓
Queuing			✓
Feedhold			✓
Feedrate Override			✓
Programmable Limit Switches			✓
Autotune	✓	✓	✓
Software Oscilloscope	✓	✓	✓
Software Watch Window	✓	✓	✓
Status Display	✓	✓	✓
User Inits		✓	✓
User Variables			✓
User Programs			✓
Cyclical Programs			✓
Real-Time Programs			✓
Program Multitasking			✓
Timers			✓
High-Speed Position Capture			✓
Modbus RTU	✓	✓	✓
DeviceNet		Opt	Opt
PROFIBUS DP			Opt
EtherNet/IP			✓
Modbus TCP/IP			✓
Modbus RTU Master			✓
Modbus Bridge/Gateway			✓
Web Page			✓
E-mail			✓
Position Tracker® - Analog	✓	✓	✓
Position Tracker® - Fieldbus		✓	✓

Powerful Features for Powerful Solutions

Advanced Features

Real-Time Programs (EP-P)

A Real-Time Program (RTP) is a user program that executes to completion in every servo update period. RTPs allow for synchronous execution of external I/O updates, communications routines or external PI control loops. They can be used for creating motion profile modifications while the application is running.

Camming (EP-P)

Programming electronic camming is now easier than ever with Control Techniques' straight forward camming function. Execute a variety of cam profiles without having to write a single line of program code. For advanced capabilities, user programs can access a wealth of cam information for unprecedented flexibility. Cam motion can be dynamically monitored and easily modified on-the-fly.

Modbus RTU Master (EP-P)/Modbus Follower (EP-I, EP-B)

No longer limited to the drive's on-board I/O, the Modbus RTU Master feature can manage a very large number of I/O and communicate updates to any Modbus follower device, giving machine builders extensive control options.

Timers (EP-P)

Built-in timers provide a simple and accurate way to trigger an action based on a previously initiated time delay. Select from up to eight different timer types to match your needs.

Ethernet Programming (EP-P)

The EP-P drive uses common Ethernet protocols for all levels of networking – to set up and monitor your application, communicate to PLC's via EtherNet/IP or connect to an operator panel using Modbus TCP/IP.

Position Tracker®

Analog and fieldbus position control allow the Epsilon EP to replace an expensive PLC motion control module with a simple, low-cost analog signal or fieldbus register. With Position Tracker®, the closed-loop feature of the position controller has been integrated into the

drive itself. The user simply sends the drive an analog or fieldbus signal that is proportional to the absolute motor/actuator position. Advanced features, including Teach functions, help speed.

Position Tracker® – Analog Mode (EP-B, EP-I)

The advantage of the Position Tracker® Analog Mode is that the drive can now use a simple and low-cost analog output module from a PLC (or analog joystick, potentiometer, lab view analog output, etc.) instead of a costly position control module. Analog mode includes several features that allow its intelligence to go beyond the initial set-up such as Mode Enable, Velocity Limits, Dead Band, Preset Calibration and Teach functions.

Position Tracker® – Fieldbus Indexing (EP-I, EP-P)

If you like the simplicity of analog position mode but require an optional command source, upgrade to the Position Tracker® Fieldbus Indexing. This indexing option tracks the updated command and dynamically indexes the motor/load. Just send a single numeric value, using fieldbus communication of your choice, to a predefined register and the motor will go to that position and hold its position until another command is sent. Commands can be sent on-the-fly even when the motor is in motion, positioning the motor to the latest command.

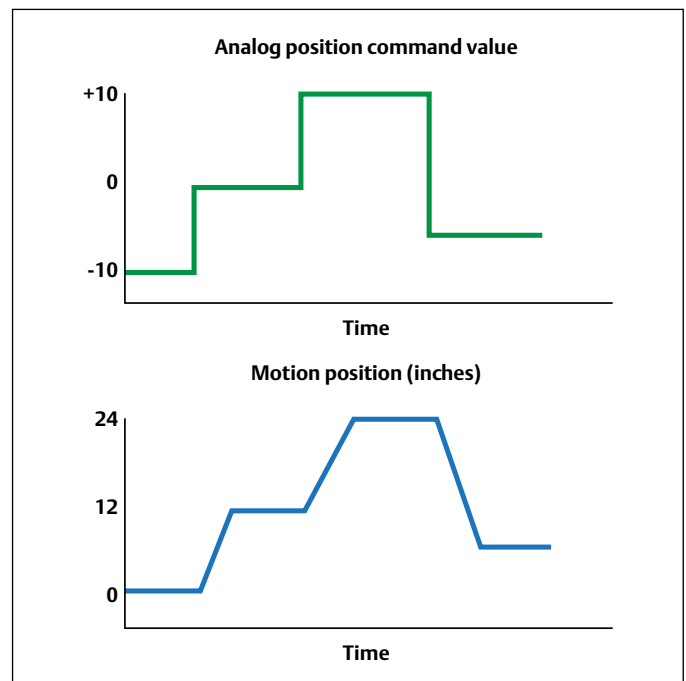

Powerful Features for Powerful Solutions

High-Speed Data Capture (EP-P)

Capture motor command position, motor position feedback, master position feedback and time within 1 microsecond after an event trigger. The High Speed Data Capture function (see Figure 1) has the functionality to initiate indexes or blended indexes and ensure that they are completed as calculated. This is achieved by internal operations that ensure the time line for motion execution is not broken and indexes automatically adjust for processor latencies.

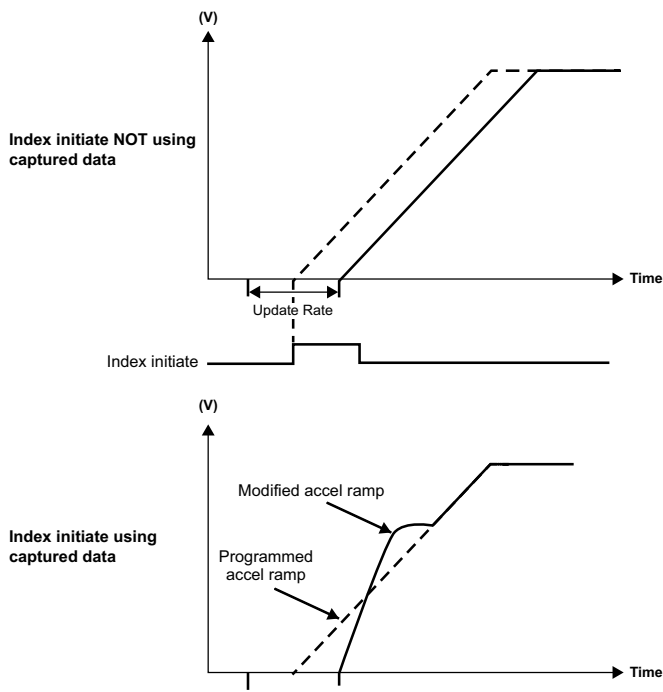

Figure 1

PLS – Programmable Limit Switches (EP-P)

Refer to Figure 2. Up to 8 outputs can be triggered to “ON” based on motor or master encoder position range that is affected by motion in one direction, both directions or rotary rollover. Another mode of the PLS allows the output(s) to be triggered by time.

Rotary rollover = 5

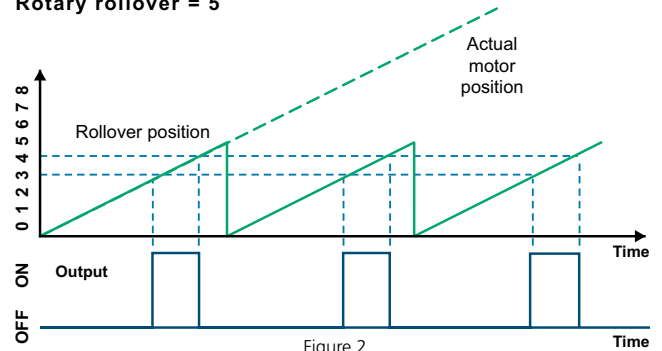

Figure 2

Dual Loop Mode (EP-P)

For those applications where it is required to command motion based on feedback from a linear encoder, for example, PowerTools Pro has the functionality to configure the EP-P drive for Dual Loop mode. Whether the feedback is linear or rotary, a user can define motion in terms of the secondary feedback and let the Epsilon calculate the relative motion required by the motor.

Feedrate/Feedhold (EP-P)

The Feedrate feature allows for adjustment of the motor velocity on-the-fly while the Feedhold feature allows for “Pause” of motion. Feedhold can be triggered by an input or event and motion stopped with a linear or S-curve deceleration, then started with a linear or S-curve acceleration. Motion stops in the middle of a motion profile and when started again will continue the interrupted motion profile.

Queue Object (EP-P)

The Queue is used in applications where multiple products exist between the incoming product sensor and the location where the process takes place (i.e. applying labels, bar code printing, vision inspection, part rejection, etc.). Up to eight Queue objects can be used simultaneously to control all of the processes in your application.

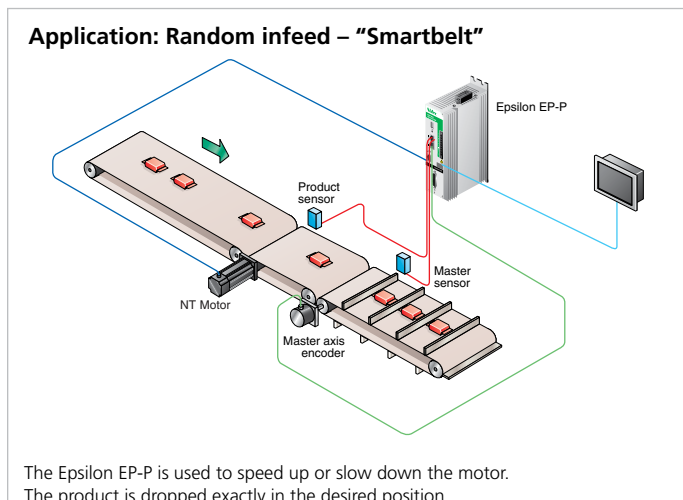

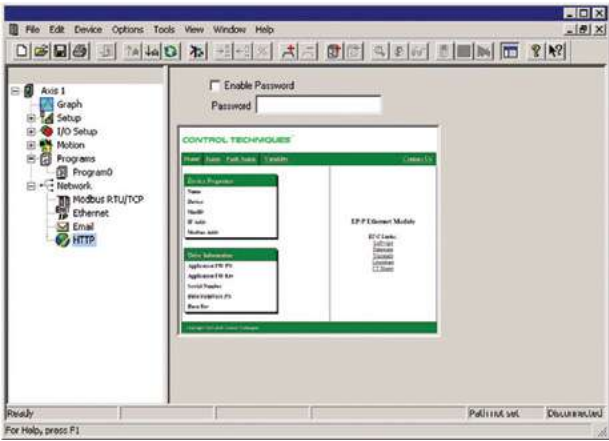

Web Browser (EP-P)

This view is used to access and set-up a password for a password-protected web page in the Epsilon EP-P drive.

Email View (EP-P)

The Email function allows a user to send a SMTP (email) message to one or more email addresses when initiated by a source or through a program. The Email view in the Network group on the hierarchy tree allows the user to set up the relay host, addresses, subject and text for the email message.

Flexible I/O Functionality

The digital I/O of the drive is completely programmable with the ability to map one or more I/O functions to the I/O points.

Base Functionality	Input Functions	Output functions
	Stop	Drive OK
	Reset	At Velocity
	Travel Limit (+ and -)	Travel Limits (+ and -)
	Torque Limit Enable	In Motion (+ and -)
	Torque Mode Enable	Power Stage Enabled
	Brake Release	Torque Limit Active
	Brake Control	Fault
	Enable Analog Position	Brake
	Teach Analog Position	Shunt Active
	Define Analog Position	Torque Level 1 Or 2 Active
	Velocity Presets (3) (EP-B only)	Foldback Active
		Power Module System Ready
	Velocity Limiting Active (EP-B only)	
Indexing Functionality*	Define Home	Torque at Max Velocity
	Jog +	Index in Position
	Jog -	Home Limit Distance Hit
	Jog Fast	End of Home
	Index Initiate	Absolute Position Valid
	Index Select 0	End of Index
	Index Select 1	End of Index Motion
	Index Select 2	End of Index Count
	Index Select 3	End of Chaining Counts
	Run Next Index	Registration Limit Distance Hit
	Home Initiate	
	Home Sensor	
	Registration Sensor 1	
Registration Sensor 2		
Repeat Current Index		

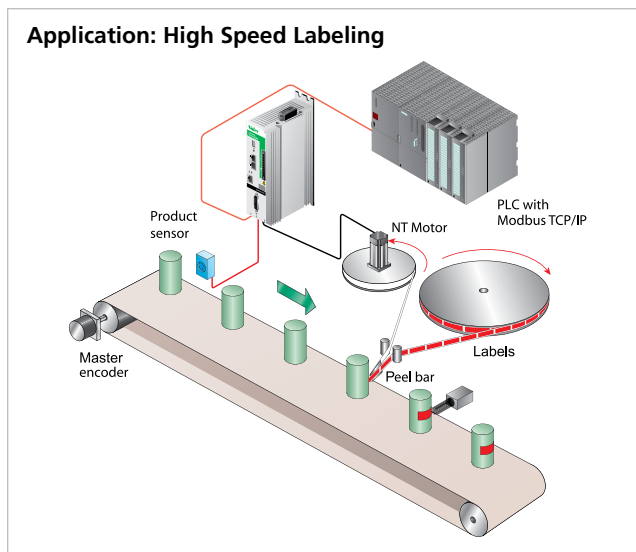

* Indexing functionality includes all of Base functionality except where noted.

Easy-to-use Software for Rapid Application Programming



“Motion Made Easy”[®]

Each step is configured using simple check boxes, drop-down selections and drag-and-drop functionality. A straightforward programming language allows users to develop more complex applications and advanced sequencing by simply dragging functions onto the work area and dropping them in place.

PowerTools Pro Software for Epsilon EP

PowerTools Pro software provides configuration and advanced motion control programming for all Epsilon EP drives. Configuration and programming is simple, easy and fast - enabling you to fully realize the power of the Epsilon EP motion controller. A familiar Microsoft® Windows® interface provides operators and machine builders with the tools needed to access everything they need for complete servo control — PLS, Queuing, High-Speed Capture, Electronic Gearing, Event Assignments and more.

Developing motion applications with PowerTools Pro is a simple “five-step, top-down” process. The five steps are displayed in a familiar “explorer” bar for easier navigation:

1. Hardware
2. Drive setup
3. I/O setup
4. Motion
5. Programs

Assignments – Use “virtual wiring” to create programs right out of the box without writing a single line of code. For example, the assignment screen (below) allows you to drag-and-drop the desired machine function onto the digital inputs and outputs.

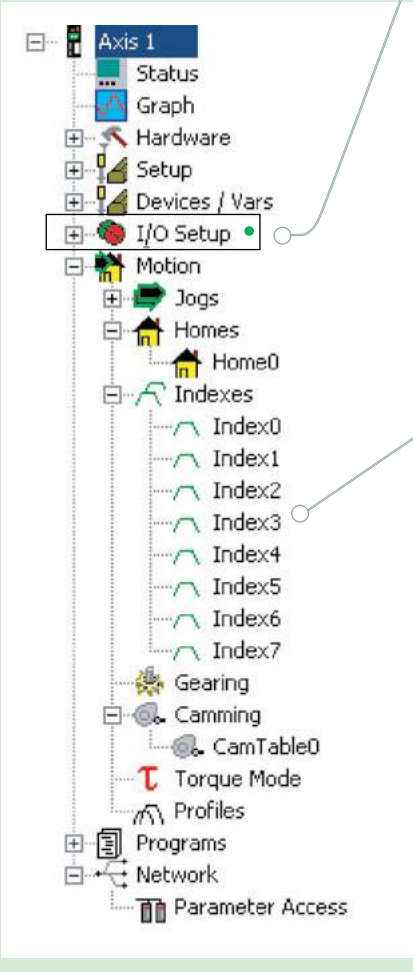

Indexes – Indexes are set up easily by filling in the screen’s blanks to create an index profile. Select from incremental, absolute, registration, or rotary plus and minus types. Choose the time base of the index by selecting either real-time or synchronized to a master. Over 100 user-defined indexes are available with the Epsilon EP.

Microsoft and Windows are registered trademarks of Microsoft Corporation in the United States and other countries.

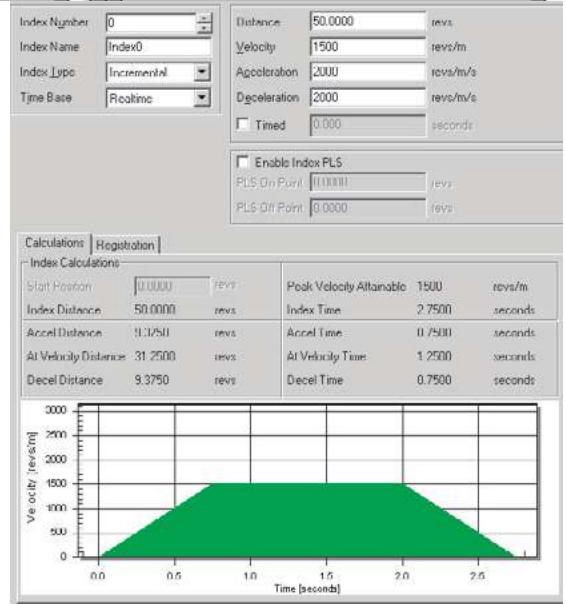
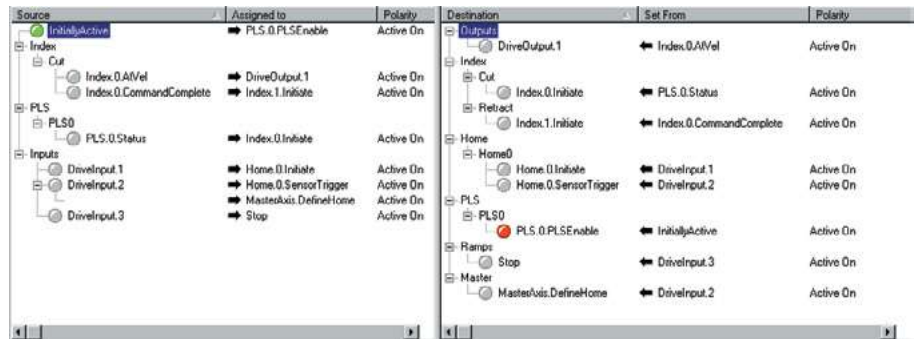

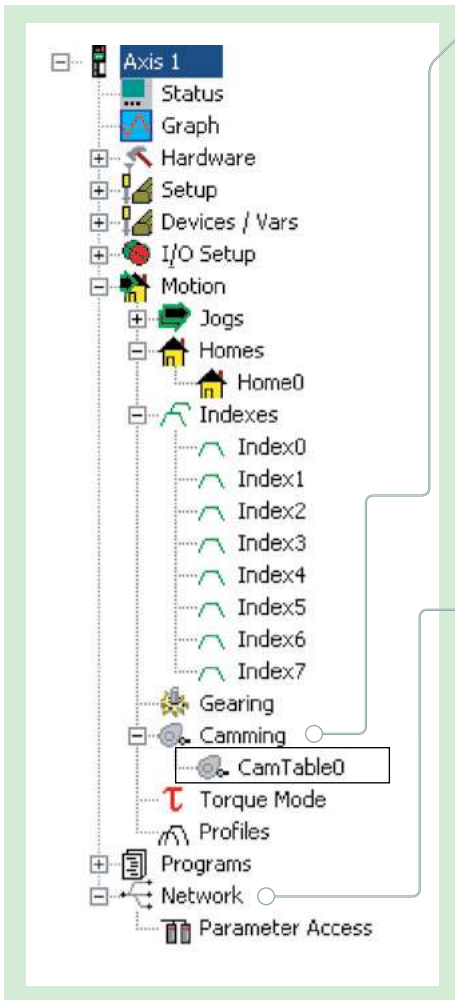

Camming – Cams make set-up and programming of complex motion profiles easy. The use of real-time programs provides smooth transitions when switching between cam profiles on-the-fly. Cam data is easily imported within PowerTools Pro and the cam graphing tool features multiple interpolation types.

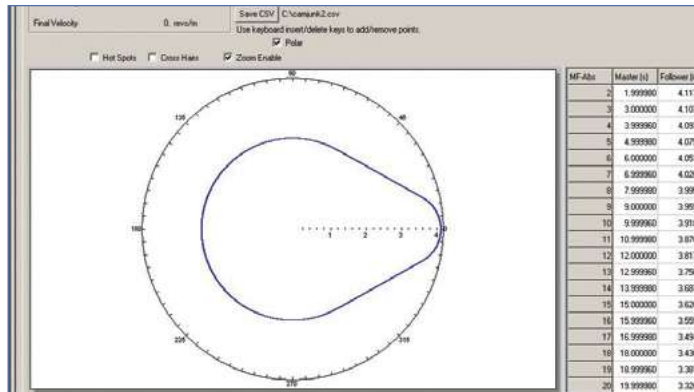

Sophisticated motion routines such as camming, gearing or multiple profile summation are easily implemented with PowerTools Pro and Epsilon EP.

Network – Whichever fieldbus is being used, setting up network communications is quick and easy. Fill-in-the-blank, drag-and-drop procedures are used to establish communication. PowerTools Pro's diagnostics allow monitoring of the actual data being sent and received.

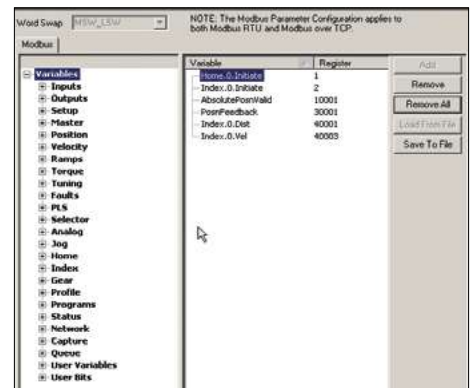

Typical Applications

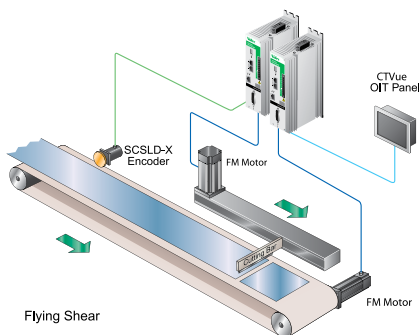

- Rotary knife
- Flying shear
- Pick and place machines
- Vertical or horizontal cartoners
- Traverse winders
- Form-fill-sealers
- Packaging systems
- Conveyor controls
- High speed labeling
- Random infeed – smart belt
- Phase synchronization
- Extend-retract
- Gluing applications
- Auger filler with analog weight check
- Semiconductor wet bath
- Dancer arm loop control
- Extruders

Epsilon EP, Fast and Easy Integration Flexibility

Software

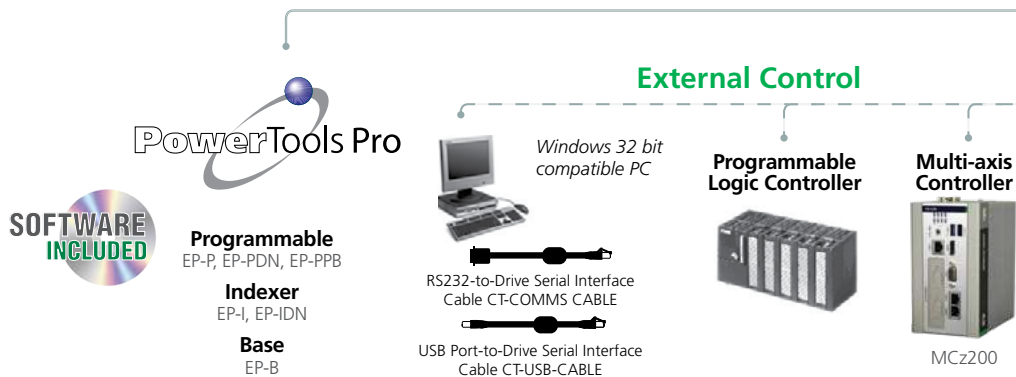

Operator Interface Options



Ethernet Switch



Interconnect Cable
 See the *Options & Accessories* brochure for order codes

Communications

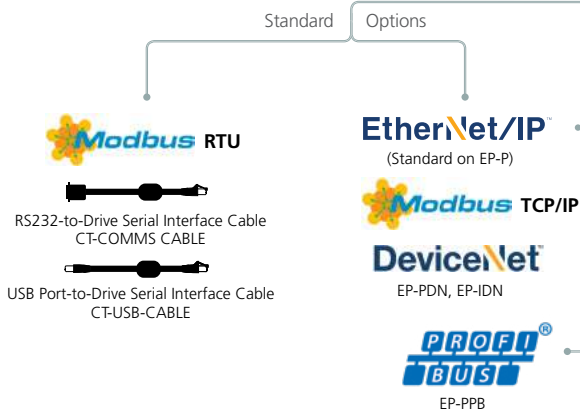

Sync encoder IN
 Sync encoder OUT

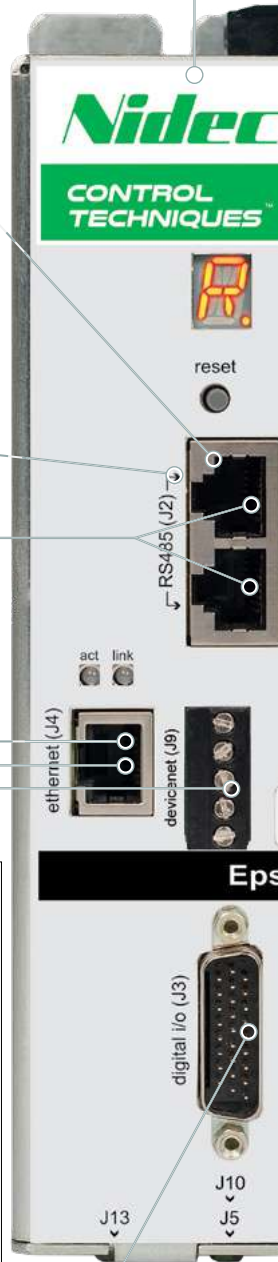
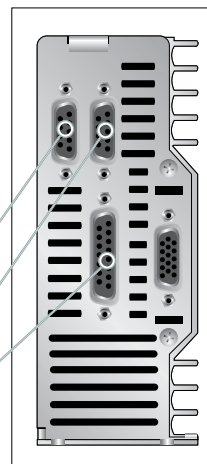

Input / Output

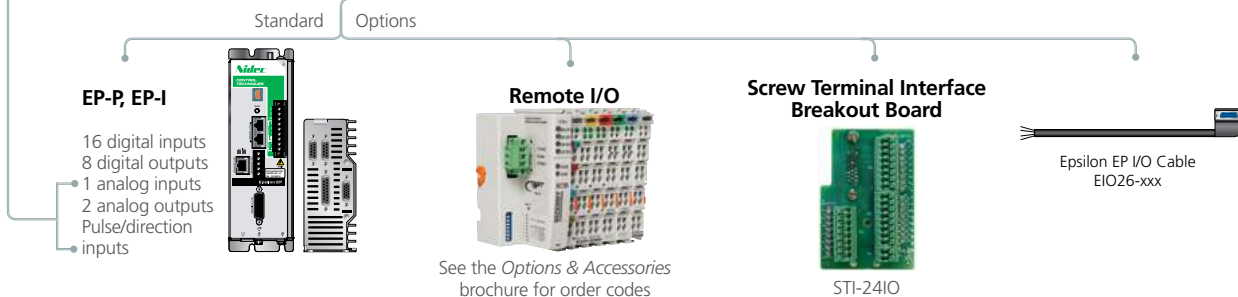

Dynamic Braking Options

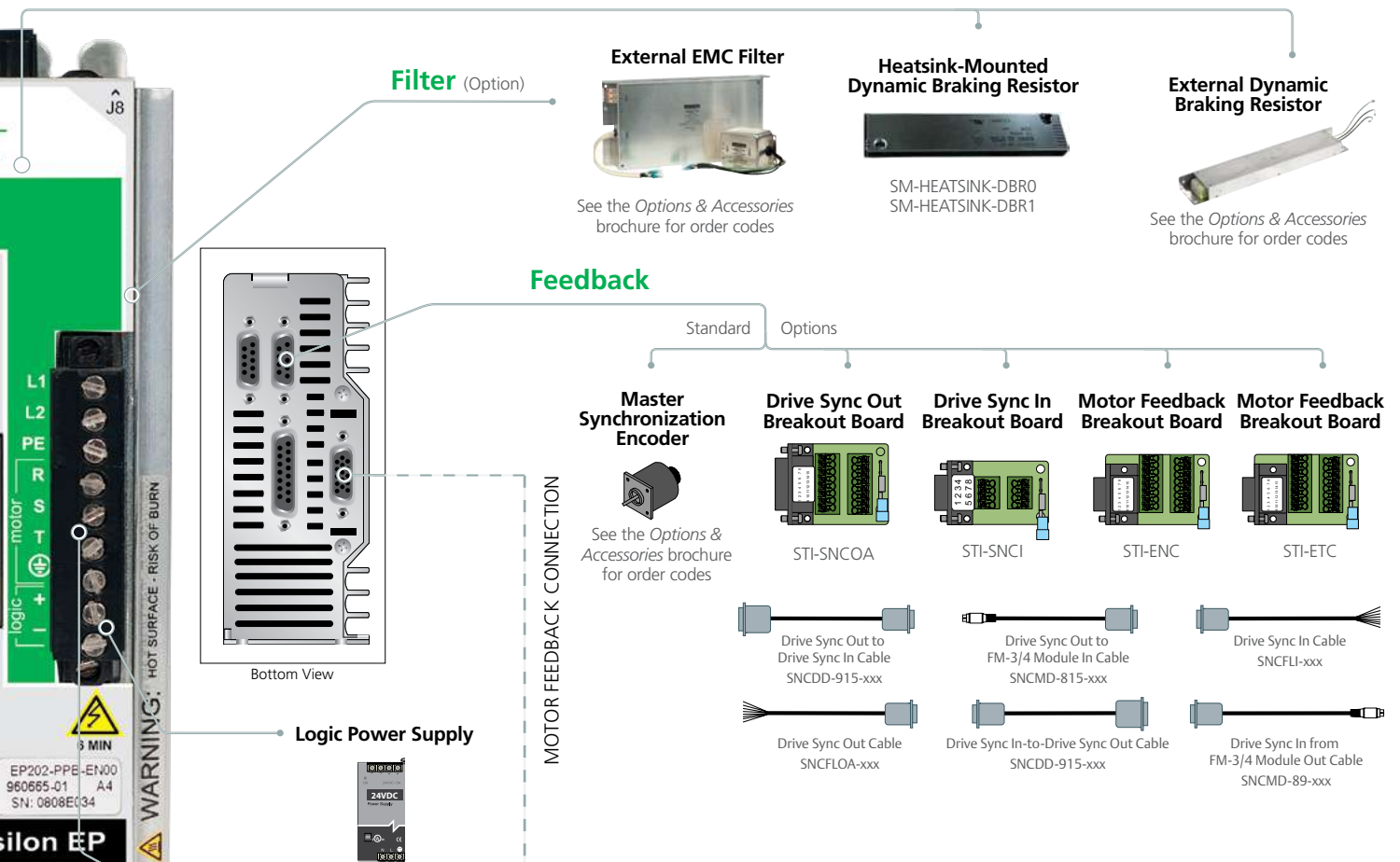

Servo Motors and Motor Cables

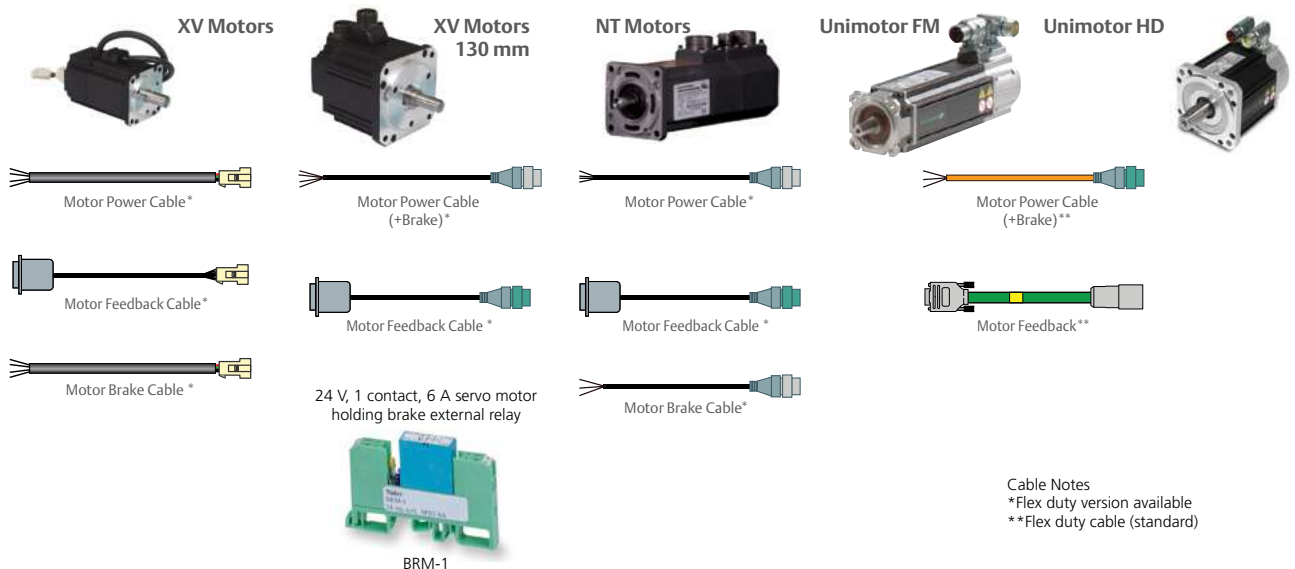



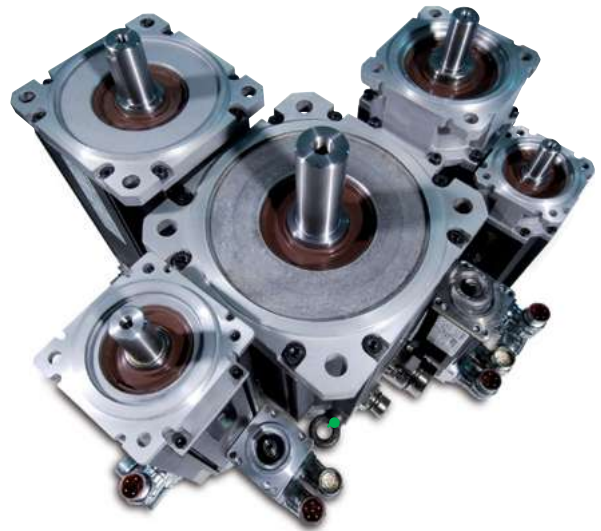

Motors to Match Your Application Needs

The Epsilon EP supports incremental feedback devices which are standard on all Control Techniques' servo motors. Control Techniques manufactures several matched motor solutions for Epsilon EP servo drives. These drive-and-motor combinations provide an optimized system in terms of ratings, performance, cost and ease of use.



Servo Motor Product Matrix

	Unimotor hd	NT Series	XV Series	Unimotor fm
Motor Family				
Epsilon EP Drive Voltage	230	230	230	230
Frame	55, 67, 89, 115, 142, 190 mm	2, 3 in	40, 60, 80, 130 mm	75, 95, 115, 142, 190 mm
Flange	IEC	IEC, NEMA	Metric	IEC
Continuous Stall Torque	Up to 916 lb-in (85 Nm)	Up to 56 lb-in (6.3 Nm)	Up to 101 lb-in (11.4 Nm)	Up to 681 lb-in (77 Nm)
Peak Torque	Up to 2257 lb-in (255 Nm)	Up to 144 lb-in (16.2 Nm)	Up to 301 lb-in (34 Nm)	Up to 2044 lb-in (231 Nm)
Base Speeds	Up to 6000 rpm	Up to 5000 rpm	Up to 5000 rpm	Up to 6000 rpm
Brake Options	24 Vdc Holding Brake			
Connector Options	Circular style frame mounted 90° and rotatable	MS or circular style frame mounted, MS style on 40° lead, flying leads, drive connector terminated leads (20 ft max.)	AMP Mat-n-Loc on 1 ft. lead (40-80 mm); MS style frame mounted (130 mm)	Circular style frame mounted 90° and rotatable; optional 90° fixed, vertical, or mixed
Inertia	Low	Low	Low, Medium	Med. (high inertia opt.)
Feedback Options	Incremental encoders, optical SinCos single & multi-turn, inductive SinCos single & multi turn, resolver, HIPERFACE (SICK) and EnDAT	Incremental 2048 line count	Incremental 2048 line count	Incremental encoders, optical SinCos single & multi-turn, inductive SinCos single & multi turn, resolver, HIPERFACE (SICK) and EnDAT
Ingress Protection	IP65	IP65, IP67, IP68	IP55, IP65	IP65
Approvals	UL, CE, RoHS	UL (RoHS opt.)	CE, UL, RoHS	CE, UL, RoHS

Selecting the Right Motor and Drive

Control Techniques' drive-and-motor combinations provide an optimized system in terms of ratings, performance, cost and ease-of-use. Use Control Techniques' software to select system components or manually select the system using the following steps.

1. Determine the application's continuous and peak torque requirements at various motor shaft speeds, then refer to motor data tables and the visual-reference overview on the facing page to help determine which motor family will be most appropriate for the application.
2. Once the motor family is selected, refer to the Control Techniques' *Servo Motors* brochure to select a specific motor that delivers the required torque and speed. Make note of the continuous and peak torque requirements of the selected motor.
3. Check the specification tables on pages 14-17 or check the drive rates table on page 19 to select the drive model that delivers adequate continuous and peak torque for the selected motor.

4. Go to the Control Techniques' *Servo Motors* brochure to select motor power and feedback cables for the selected drive/motor combination.

For optimum performance, verify the rotor inertia ratio is <10 when calculated with the load inertia using the following equation:

$$\text{Load inertia/rotor inertia}$$

Note: A gear reducer will reduce the load inertia based on the following equation:

$$\text{Reflected load inertia} = \text{load inertia/gear ratio}^2$$

Note: Epsilon EP-B, EP-I and EP-P can handle up to 50:1 inertia ratio effectively. When specifying a motor system, be sure to consider such factors as user-interface (HMI) options, braking resistors and other options and accessories that will enhance the system's performance and value.

Example (using Unimotor hd family):

Step 1: The application requires 25 lb-in continuous torque @ 2000 rpm.

Step 2: The Control Techniques *Servo Motors* brochure lists the HD89EDB300 motor with 42.92 rated torque at 3000 rpm. Select Epsilon EP drive-and-motor combination.

Step 3: Select the appropriate power and feedback cables.

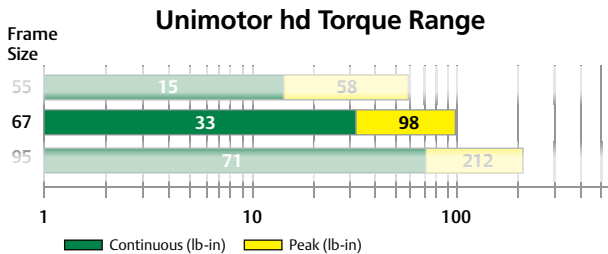

Epsilon EP and Unimotor hd – 230 V, 3Ø								
Drive Model	Motor Model	Cont. Stall Torque lb-in (Nm)	Peak Torque lb-in (Nm)	Rated Torque @ Rated Speed lb-in (Nm)	Rated Power HP (kW)	Rated Operating Speed – rpm	Inertia lb-in sec ² (kgm ²)	Kt lb-in/Arms (Nm/Arms)
EP204	HD 67EDB600	16.46 (1.86)	32.92 (3.72)	16.46 (1.86)	1.56 (1.17)	6000	.00046 (.000053)	4.12 (.47)
EP206	HD 67EDB600	22.57 (2.55)	53.50 (6.05)	19.47 (2.20)	1.84 (1.38)	6000	.00046 (.000053)	4.12 (.47)
EP206	HD 89EDB300	48.68 (5.50)	107.00 (12.09)	42.92 (4.85)	2.03 (1.52)	3000	.00142 (.000161)	8.23 (.93)
EP209	HD 89EDC300	70.80 (8.00)	148.15 (16.74)	61.07 (6.90)	2.89 (2.17)	3000	.00207 (.000234)	8.23 (.93)
EP209	HD 115EDB300	74.07 (8.37)	148.15 (16.74)	68.15 (7.70)	3.22 (2.42)	3000	.00390 (.000441)	8.23 (.93)

Matched Solution: Epsilon EP and Unimotor hd

Unimotor hd 230 V

The Unimotor hd is a high-dynamic servo motor range designed for maximum torque density. This brushless AC servo motor range provides an exceptionally compact, low-inertia solution for applications where very high torque is required during rapid acceleration and deceleration profiles.

The Unimotor hd torque profile is closely matched to Epsilon EP servo drives providing up to 200% peak overload for maximum dynamic performance. Unimotor hd incorporates a number of unique performance-enhancing design features.

- High torque-to-inertia ratio for high-dynamic performance
- High-energy dissipation brakes
- Compact and powerful

- IP65, rating, UL, CE and RoHS compliant
- Supported by rigorous testing for performance and reliability

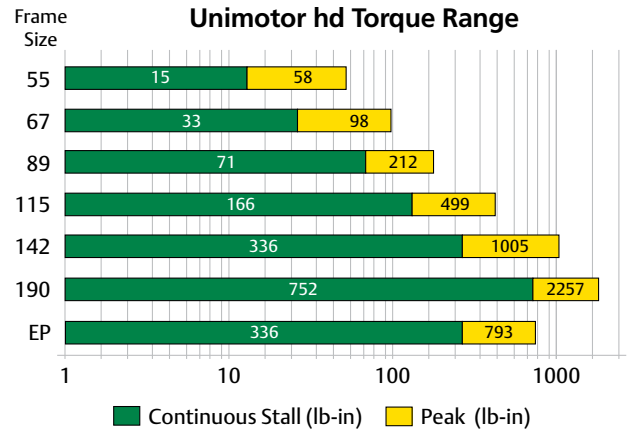

Sample Motor and Drive Combinations

Epsilon EP and Unimotor hd – 230 V, 1Ø														
Drive Model	Motor Model	Cont. Stall Torque		Peak Torque		Rated Torque		Rated Power		Rated Operating Speed	Inertia		Kt	
		lb-in	Nm	lb-in	Nm	lb-in	Nm	HP	kW		rpm	lb-in sec ²	kgm ²	lb-in/Arms
EP202	055EDC300	14.60	1.65	35.44	4.00	13.10	1.48	0.60	0.46	3000	0.00032	0.000036	8.05	0.91
EP206	067EDB600	22.57	2.55	56.15	6.35	19.47	2.20	1.81	1.38	6000	0.00047	0.000053	4.25	0.47
EP206	089EDB300	48.68	5.50	111.11	12.56	43.37	4.85	1.81	1.52	3000	0.00142	0.000161	8.23	0.93
EP209	089EDC300	70.80	8.00	148.15	16.74	61.07	6.90	2.84	2.17	3000	0.00207	0.000234	8.23	0.93
EP216*	089EDC400	70.80	8.00	198.24	22.40	56.20	6.35	3.48	2.66	4000	0.00207	0.000234	6.20	0.70
EP216*	115EDB300	90.27	10.20	263.38	29.76	68.15	7.70	3.17	2.42	3000	0.00390	0.000441	8.23	0.93
EP216*	115EDC300	129.21	14.60	263.38	29.76	92.93	10.50	4.32	3.30	3000	0.00566	0.000639	8.23	0.93

NOTES: Drive switching frequency 10 kHz unless noted; refer to the *Servo Motors* brochure for complete motor model number.
*3 phase ratings listed

Order Information

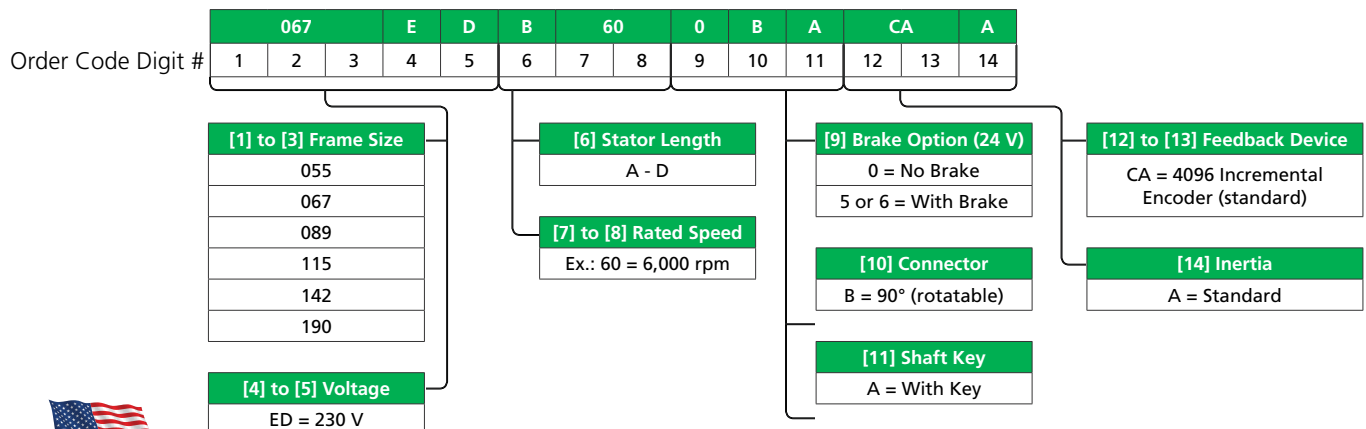

Assembled in the U.S.A.

Matched Solution: Epsilon EP and NT Servo Motor

NT Series Servo Motor 230 V

The rugged NT motor is designed for the most stringent servo applications. Now available with multiple feedback options and white epoxy food-grade finish, the NT motor is an economical, high-performance motor made to maximize torque and minimize size. The NT motor uses powerful Neodymium magnets and is manufactured with a segmented core to maximize stator efficiency and further reduce size.

- Continuous torque range up to 56 lb-in (6.3 Nm)
- Peak torque over 2.5 X continuous torque
- Low-inertia, high-performance motor
- Rated speeds: 3000, 4000 and 5000 rpm

- Frame sizes in English (NEMA 23 or 34) or Metric (IEC-72-1)
- Flying lead cabling options
- IP65, IP67 & IP68 rating, UL, RoHS optional

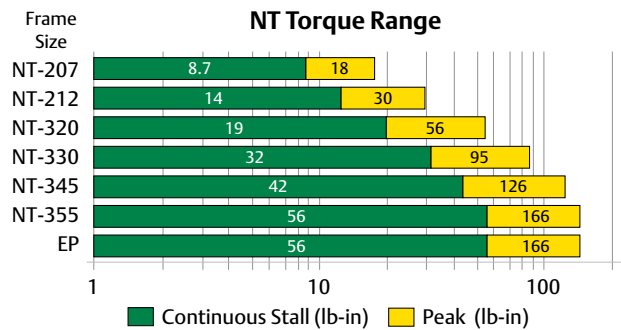

Sample Motor and Drive Combinations

Epsilon EP and NT Motor – 230 V, 1Ø														
Drive Model	Motor Model	Cont. Stall Torque		Peak Torque		Rated Torque		Rated Power		Rated Operating Speed	Inertia		Kt	
		lb-in	Nm	lb-in	Nm	lb-in	Nm	HP	kW		rpm	lb-in sec ²	kgm ²	lb-in/Arms
EP202	NT207	7.5	0.80	22.50	2.54	7.30	0.82	0.58	0.43	5000	0.00009	0.000011	5.12	0.58
EP204	NT212	12.5	1.40	40.60	4.58	12.50	1.41	0.99	0.73	5000	0.00016	0.000019	5.08	0.57
EP 206	NT320	19.7	2.20	45.50	5.14	16.00	1.80	1.02	0.76	4000	0.00033	0.000037	3.50	0.40
EP206	NT330	31.5	3.50	65.52	7.40	31.50	3.55	2.00	1.49	4000	0.00044	0.000049	5.04	0.57
EP206	NT345	47.0	5.31	92.69	10.47	47.00	5.31	2.24	1.67	3000	0.00067	0.000075	7.13	0.81
EP209	NT355	55.5	6.27	131.40	14.84	55.50	6.27	2.64	1.96	3000	0.00089	0.000010	7.30	0.82

NOTES: Drive switching frequency 10 kHz unless noted; refer to the *Servo Motors* brochure for complete motor model number.

Order Information

Order Code Digit #

NT	M-	2	12-	C	0	N	S-	0000					
1	2	3	4	5	6	7	8	9	10	11	12	13	14

[1] to [2] Motor Family
NT = 230 V

[3] Mounting Flange
E = NEMA
M = Metric (IEC-72-1)

[4] Frame Size
2 = 2 in NEMA 23
3 = 3 in NEMA 34

[5] to [6] Torque Rating
07, 12, 20, 30, 45, 55

[7] Connection Type
C = MS Connectors (IP65)
T = MS Connector on Leads (IP65)
L = Flying Leads, no connector (IP65)
E = 90° Rotatable (IP67)
F = Flying Leads w/white epoxy finish (IP68S)

[8] Brake Option (24 V)
0 = No Brake
B = With Brake

[9] Feedback Device
N = 2048 ppr Encoder (std)

[10] Inertia
S = Standard

[11] to [12] Flying Lead (opt)
00 = Standard
DP = 15-pin D-sub feedback connector for direct connection to Epsilon EP

[13] to [14] Flying Lead Length
00 = Standard
05 = 5 ft (+5-ft increments); max. length = 20 ft



White epoxy food-grade option



Assembled in the U.S.A.

Matched Solution: Epsilon EP and XV Servo Motor

XV Series Servo Motor 230 V

The XV series servo motors provide a low-cost, high-quality servo motor solution for light industrial applications. The XV offers the smallest frame sizes of any servo motors from Control Techniques starting at 40 mm. This compact motor is a great solution for many servo applications and is also a good option for stepper motor replacements. XV servo motors are available in 230 Vac input voltage rating with a 2048 ppr incremental encoder.

- Available in four frame sizes: 40, 60, 80 and 130 mm
- Speed range from 2000 to 5000 rpm

- Cost-effective replacement for stepper motor
- CE, UL and RoHS compliant

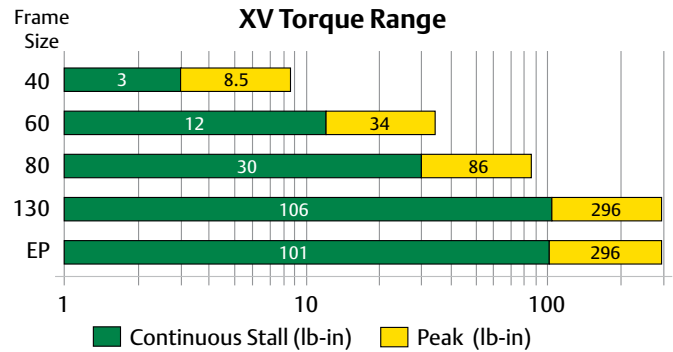

Sample Motor and Drive Combinations

Epsilon EP and Unimotor XV – 230 V, 1Ø														
Drive Model	Motor Model	Cont. Stall Torque		Peak Torque		Rated Torque		Rated Power		Rated Operating Speed rpm	Inertia		Kt	
		lb-in	Nm	lb-in	Nm	lb-in	Nm	HP	kW		lb-in sec ²	kgm ²	lb-in/Arms	Nm/Arms
EP202	XV-402	1.41	0.16	4.00	0.45	1.41	0.16	0.07	0.05	3000	0.00002	0.000002	1.24	0.14
EP202	XV-403	2.81	0.32	7.70	0.87	2.80	0.32	0.13	0.10	3000	0.00004	0.000004	2.21	0.25
EP202	XV-606	5.70	0.64	16.10	1.82	5.70	0.64	0.27	0.20	3000	0.00016	0.000018	3.72	0.42
EP204	XV-6011	11.20	1.27	32.30	3.65	11.20	1.27	0.54	0.40	3000	0.00028	0.000032	4.07	0.46
EP204	XV-8017	16.90	1.91	39.70	4.48	16.90	1.91	0.80	0.60	3000	0.00096	0.000109	4.96	0.56
EP204	XV-8023	23.30	2.63	51.00	5.76	23.30	2.63	0.74	0.55	2000	0.00133	0.000151	6.37	0.72
EP206	XV-8028	28.10	3.17	71.50	8.08	28.10	3.17	1.34	1.00	3000	0.00170	0.000192	5.50	0.62
EP206	XV-13046	46.50	5.25	97.50	11.00	46.50	5.25	1.48	1.10	2000	0.01100	0.001245	7.50	0.85
EP206	XV-13051	50.70	5.73	148.00	16.70	50.70	5.73	0.80	0.60	1000	0.01100	0.001245	12.60	1.42
EP216*	XV-13068	67.60	7.64	199.00	22.50	67.60	7.64	2.15	1.60	2000	0.01530	0.001732	74.0	0.84
EP209	XV-13089	88.80	10.00	242.00	27.40	88.80	10.00	1.41	1.05	1000	0.01530	0.001732	13.50	1.52
EP209	XV-130101	101.00	11.50	245.00	27.70	101.00	11.50	1.61	1.20	1000	0.02001	0.002265	13.60	1.54

NOTES: Drive switching frequency 10 kHz unless noted; refer to the *Servo Motors* brochure for complete motor model number.
*3 phase ratings listed

Order Information

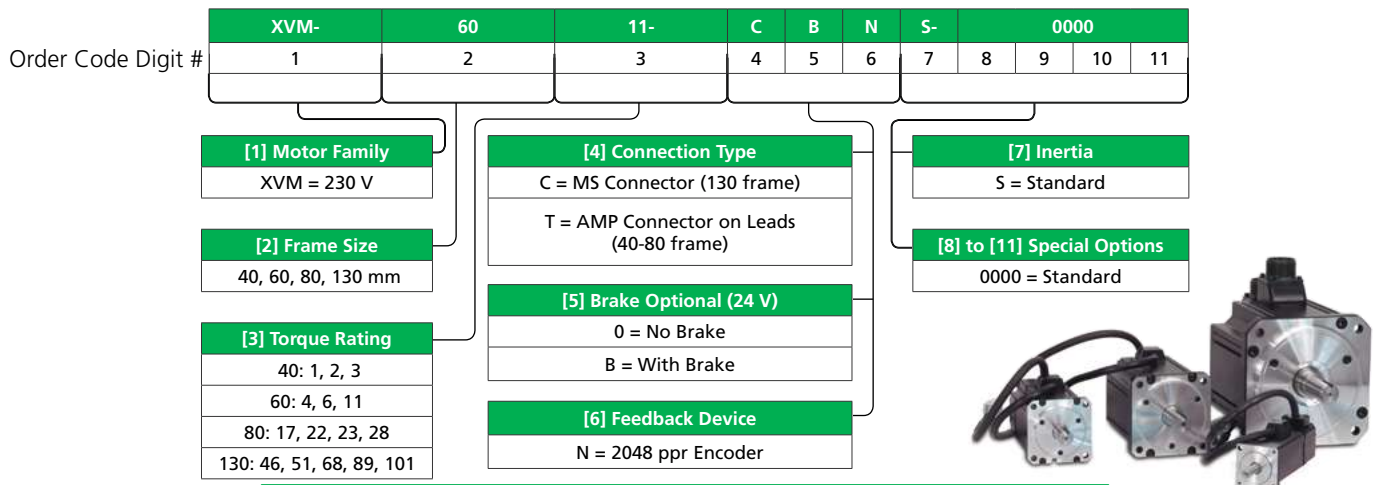

Matched Solution: Epsilon EP and Unimotor fm Servo Motor

Unimotor fm Series Servo Motor 230 V

Control Techniques' Unimotor fm flexible motor series is designed to accommodate a wide range of applications with a highly configurable selection of feedback devices, shafts, inertias and more.

- Medium inertia
- IEC mounting (NEMA option on 95 and 142 frames only)
- Configuration options include brake, bolt circle, shaft diameter, plus high-peak and high-inertia options
- Multiple feedback options
- IP65 rating, UL, CE and RoHS compliant

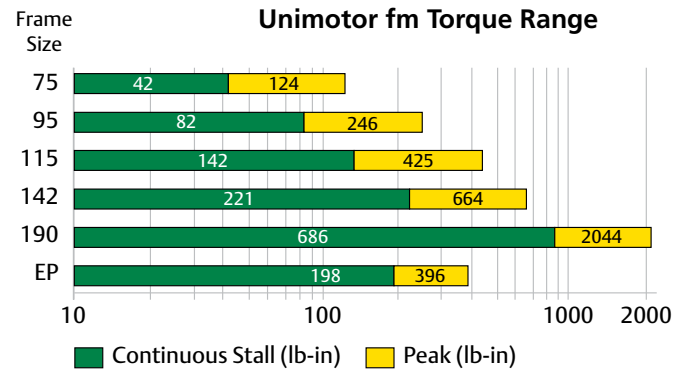

Sample Motor and Drive Combinations

Epsilon EP and Unimotor fm – 230 V, 1Ø														
Drive Model	Motor Model	Cont. Stall Torque		Peak Torque		Rated Torque		Rated Power		Rated Operating Speed	Inertia		Kt	
		lb-in	Nm	lb-in	Nm	lb-in	Nm	HP	kW		rpm	lb-in sec ²	kgm ²	lb-in/Arms
EP202	075E3A40	12.39	1.40	27.26	3.08	10.62	1.20	0.67	0.50	4000	0.00071	0.00008	6.20	0.70
EP204	075E3B40	23.90	2.70	49.56	5.60	18.59	2.10	1.15	0.86	4000	0.00106	0.00012	6.20	0.70
EP206	075E3C40	32.75	3.70	80.54	9.10	24.78	2.80	1.57	1.17	4000	0.00142	0.00016	6.20	0.70
EP206	075E3D30	41.60	4.70	107.00	12.09	37.17	4.20	1.76	1.31	3000	0.00186	0.00021	8.23	0.93
EP206	095E3B40	39.83	4.50	80.54	9.10	33.63	3.80	2.13	1.59	4000	0.00230	0.00026	6.20	0.70
EP209	095E3D30	69.92	7.90	148.15	16.74	61.07	6.90	2.91	2.17	3000	0.00425	0.00048	8.23	0.93
EP216*	095E3D40	69.92	7.90	198.24	22.40	56.64	6.40	3.59	2.68	4000	0.00425	0.00048	6.20	0.70
EP209	115E3B30	65.49	7.40	148.15	16.74	59.30	6.70	2.82	2.10	3000	0.00681	0.00077	8.23	0.93
EP216*	115E3C30	95.58	10.80	263.38	29.76	84.08	9.50	4.00	2.98	3000	0.00885	0.00100	8.23	0.93
EP216*	115E3E30	131.69	14.88	263.38	29.76	104.55	11.81	4.98	3.71	3000	0.01310	0.00148	8.23	0.93
EP216*	190E3B20	198.24	22.40	396.48	44.80	181.18	20.47	5.75	4.29	2000	0.04407	0.00498	12.39	1.40

NOTES: Drive switching frequency 10 kHz unless noted; refer to the *Servo Motors* brochure for complete motor model number.
*3 phase ratings listed

Order Information

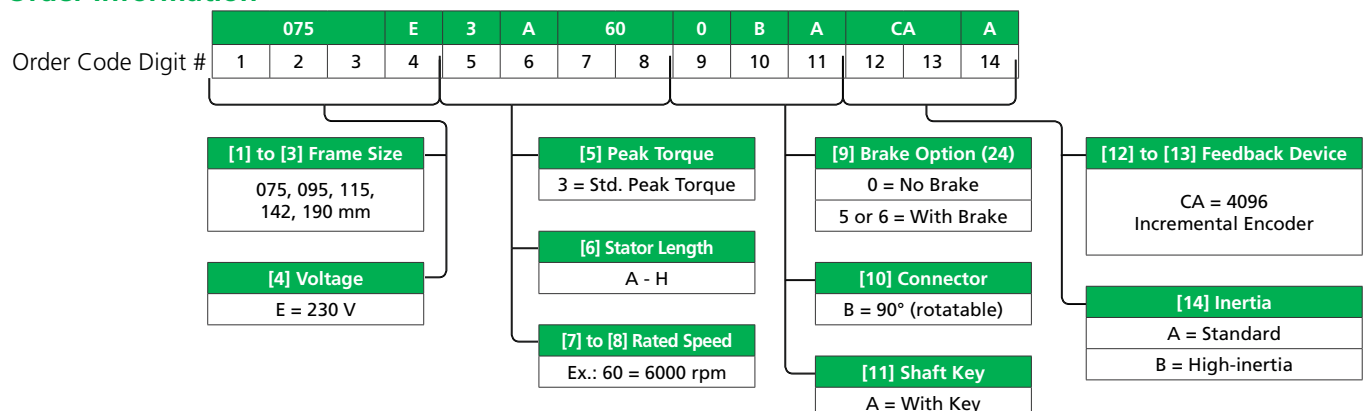

Terminals and Pinouts

RS485 - Communications (J2)	
Pin #	Signal
1	120 Ω Termination Resistor
2	RX TX
3	Isolated 0 V
4	+15 V
5	Isolated 0 V
6	TX Enable
7	RX/ TX/
8	RX/ TX/ (if termination resistors are required, link to pin 1)
Shell	PE

Ethernet (J4) (EP-P ONLY)	
Pin #	Signal
1	TX+Ve
2	TX-Ve
3	RX+Ve
4	N/C
5	N/C
6	RX-Ve
7	N/C
8	N/C

DeviceNet (J9) (EP-PDN, IDN ONLY)	
Pin #	Signal
1	V-
2	CAN_L
3	Shield
4	CAN_H
5	V+

PROFIBUS (J13) (EP-PPB ONLY)	
Pin #	Signal
3	B
8	A

Sync In (J10)	
Pin #	Signal
1	Encoder In A
2	Encoder In A/
3	Encoder In B
4	5 Vdc
5	Encoder In B/
6	Encoder In Z
7	Encoder In Z/
8	Logic Common
9	N/C

Analog, Sync Out (J5)	
Pin #	Signal
1	Encoder Out A
2	Encoder Out B
3	Encoder Out Z
4	Pulse In
5	Analog In +
6	Analog Ground
7	Analog Out 1
8	Logic Common
9	Encoder Out A/
10	Encoder Out B/
11	Encoder Out Z/
12	Direction In
13	Analog In -
14	Analog Ground
15	Analog Out 2

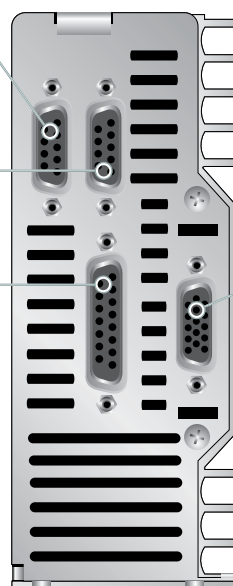
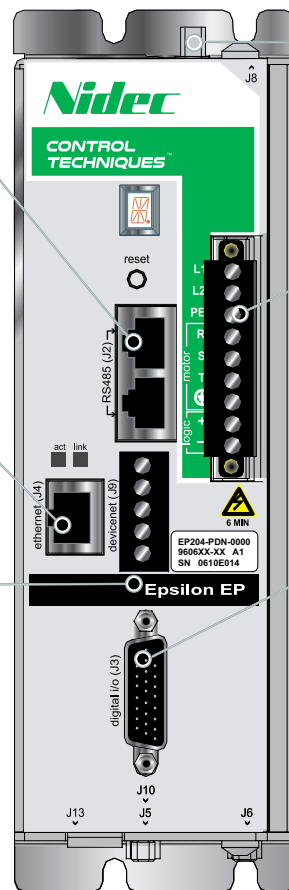

(Bottom View)

Shunt (J8)	
Pin #	Signal
1	B+
2	PE
3	SH
4	PE
5	B-

Power (J1)	
Pin #	Signal
L1	AC Input L1
L2	AC Input L2
PE	PE
Motor R	Motor Power R
Motor S	Motor Power S
Motor T	Motor Power T
Gnd	Motor Ground
Logic +	Logic +24 Vdc
Logic -	Logic 0 Vdc

Digital I/O (J3)	
Pin #	Signal
1*	Input 1
11*	Input 2
2*	Input 3
12*	Input 4
3	Input 5
13	Input 6
4	Input 7
14	Input 8
5	Input 9
15	Input 10
6	Input 11
16	Input 12
10*	Drive Enable
19	I/O + Vdc
20	I/O Common
7	Output 1
17	Output 2
8	Output 3
18	Output 4
9	Output 5
25	Output 6
26	Output 7
21	Output 8
22	Input 13
23	Input 14
24	Input 15

*Epsilon EP-B includes these pinouts only

Motor Feedback (J6)	
Pin #	Signal
1	Encoder A
2	Encoder A/
3	Encoder B
4	Encoder B/
5	Encoder Z
6	Encoder Z/
7	Commutation U
8	Commutation U/
9	Commutation V
10	Commutation V/
11	Commutation W
12	Commutation W/
13	5 Vdc Power
14	Ground
15	Motor OverTemp

Epsilon EP Specifications and Dimensions

Specifications

Power Requirements

AC input voltage, 47-63 Hz
 EP-202/204/206: 1Ø, 20 to 264 Vac
 EP-209: 1Ø, 90 to 264 Vac
 EP-216: 1Ø/3Ø, 90 to 264 Vac
 (240 Vac for rated performance) fault current 10 kA

DC input voltage
 EP-202/204/206: 10 to 340 Vdc
 EP-209/216: 140 to 340 Vdc

AC input current (max. continuous)
 EP-202: 5.0 Arms (140 A for 2 ms inrush)
 EP-204: 8.5 Arms (140 A for 2 ms inrush)
 EP-206: 12.0 Arms (140 A for 2 ms inrush)
 EP-209: 18 Arms (34 A for 5 ms inrush)
 EP-216: 36 Arms (34 A for 5 ms inrush)

Output current continuous (rms) / Peak (4 sec.)
 EP-202: 2.2 A / 4.4 A
 EP-204: 4.0 A / 8 A
 EP-206: 6.5 A / 13 A
 EP-209: 9.0 A / 18 A
 EP-216: 16.0 A / 32 A

Continuous output power
 EP-202: 0.775 kW
 EP-204: 1.275 kW
 EP-206: 1.775 kW
 EP-209: 2.325 kW
 EP-216: 4.8 kW

Switching Frequency 10 kHz
External Logic Supply 24 Vdc ± 10% @ 0.5 A
Encoder Supply Output +5 Vdc, 250 mA
I/O Supply +10 to 30 Vdc

System Efficiency 93%
Cooling Method Convection

Regeneration

Internal energy absorption (115 V / 230 V)
 EP-202: 39 Joules / 8 Joules
 EP-204: 58 Joules / 12 Joules
 EP-206: 97 Joules / 20 Joules
 EP-209: 117 Joules / 24 Joules
 EP-216: 132 Joules / 28 Joules

External: Connection to external resistor,
 33 Ω min, 15 Arms, 2 kW

EP216: 20 Ω, 20 Arms, 5 kW

Drive Control Inputs

Analog: (1) +/-10 Vdc, 14 bit, 100 kOhm, differential

Analog max. input rating: differential
 +/-14 Vdc, each input with reference

to analog ground +/-14 Vdc

Digital: (16) (5 on EP-B) +10 to 30 Vdc,
 4.8 kΩ, sourcing, optically isolated

Pulse: (1) Differential RS-422, 1 MHz/channel,
 50% duty cycle

Single-ended: (1) TTL Schmitt trigger
 500 kHz/channel, 50% duty cycle

Motor overtemperature: 0 to +5 Vdc,
 1 kΩ, single-ended

Drive Control Outputs

Analog: (2) +/-10 Vdc, 10 bit, single-ended

20 mA

Digital: (8) (3 on EP-B) +10 to 30 Vdc, 150 mA,
 sourcing optically isolated

Pulse: Differential RS-422 and TTL compatible,
 20 mA/channel sink or source

Environmental

Rated ambient temperature: 32 to 104 °F
 (0 to 40 °C) for rated performance

Maximum ambient temperature: 32 to 122 °F
 (0 - 50° C) with power derating of 3.0%/ 1 °C
 above 40 °C

Rated altitude: 1000 m

Maximum altitude: For altitudes > 1000 m derate
 output by 1%/100 m

Vibration: 10 to 2000 Hz @ 2g

Humidity: 10 to 95% non-condensing

Storage temperature: -13 to 167 °F
 (-25 to 75 °C)

Ingress protection: IP-20

Serial Interface

2 RS-485 connectors for multi-drop
 applications Modbus RTU w/ 32-bit extension,
 9600 to 19.2kBaud

Ethernet Interface (EP-P only)

1 RJ-45, Modbus TCP/IP or EtherNet/IP
 @ 10/100 M bandwidth

DeviceNet (EP-xDN models only)

Power consumption: 25 mA
 Baud rates: 125, 250 and 500 kps
 Node addresses: 00-63

PROFIBUS DP (EP-PPB model only)

Baud: 1.5 to 12 Mb
 Address Range: 00 to 126

Dimensions

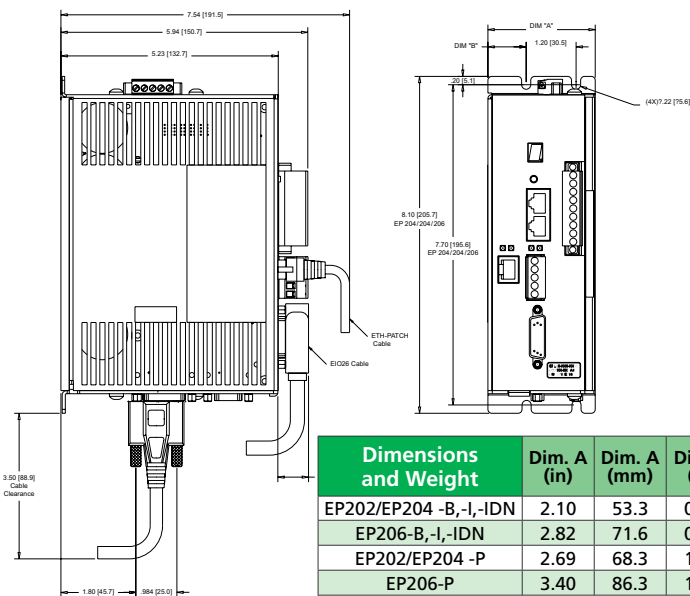

Epsilon EP Order String

EP X XX - X XX - XX XX

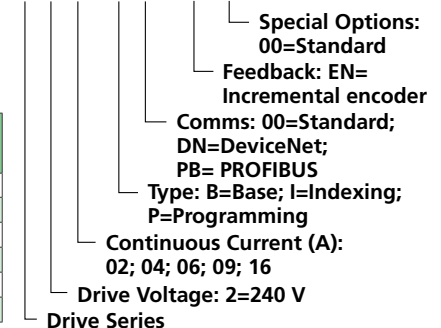

CONTROL TECHNIQUES™

www.controltechniques.com

Connect with us at:

[Twitter.com/Nidec_CTA](https://twitter.com/Nidec_CTA)

[Facebook.com/NidecCTA](https://facebook.com/NidecCTA)

[Youtube.com/c/NidecControlTechniquesAmericas](https://youtube.com/c/NidecControlTechniquesAmericas)

[Linkedin.com/company/control-techniques](https://linkedin.com/company/control-techniques)

theautomationengineer.com (blog)



©2018 Control Techniques a Nidec Motor Corporation business. The information contained in this brochure is for guidance only and does not form part of any contract. The accuracy cannot be guaranteed as Control Techniques has an ongoing process of development and reserves the right to change the specifications of its products without notice. Unidrive and Control Techniques are registered marks of Nidec Control Techniques Limited in the USA.

Control Techniques
7078 Shady Oak Road Eden Prairie, MN 55344-3505 USA