

- Squeeze-out unit suitable for 310 ml Euro cartridges
- Integrated pressure controller 0 to 3.5 bar
- Available on request incorporated into unit or with attached manual handle
- Special adaptor for the processing of plastic tubes



The cartridge gun is ideal when working with 310 ml Euro cartridges or plastic tubes. In combination with the attached handle with integrated pneumatic valve, it becomes a reliable low-cost alternative for single point and bead dispensing.

For high-quality metering and automatized use we recommend you chose the squeeze-out device incorporated into an unit and to combine it with an appropriate metering valve. Thus, accurately reproducible metering quantities and neat treatment without draining become possible.

Technical data:

Cartridge dispensing	310 ml Euro standard
Cartridge diameter	max. 45 mm
Cartridge length	max. 215 mm
Compressed air connection	R 1/4" - hose Ø 6 mm
Supply pressure	max. 8.5 bar
Adjustment range	0 to 3.5 bar
Weight	680 grams

Dimensions:

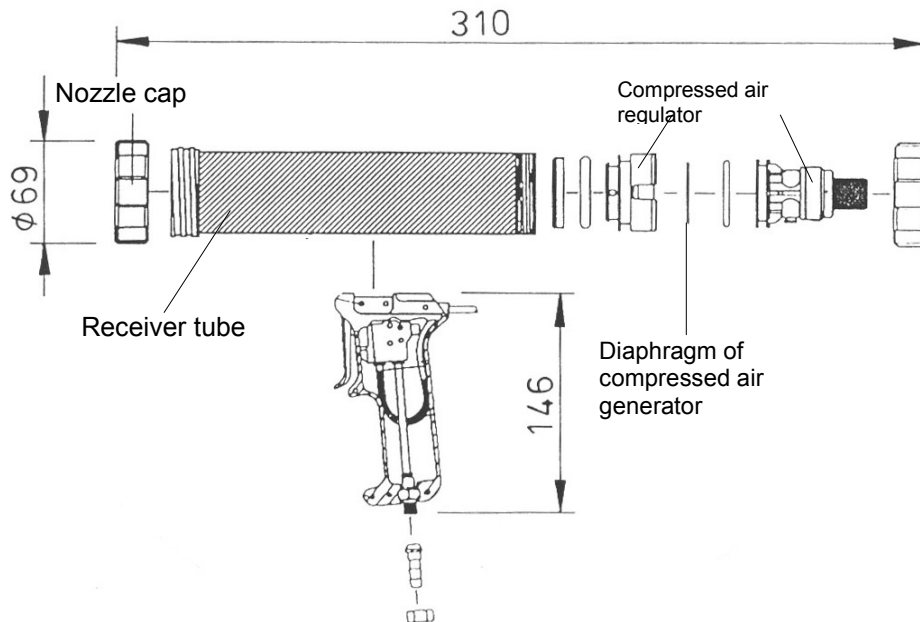

Ordering data:

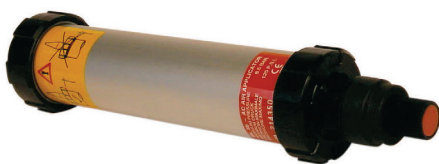

Article/Nomenclature

Cartridge squeeze-out unit

Material no.







on request

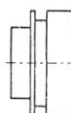
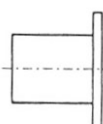

Gun handle with integrated pneumatic valve completely assembled

on request

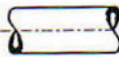
Accessories:

	Article/Nomenclature	Material no.
	Textile-reinforced PVC hose Ø 6/12 mm for air connection at gun handle	417400123
	Hose clamp for textile-reinforced PVC hose	415013303
	PA hose Ø 3.3 / 5 mm for air connection at cartridge squeeze-out unit	417400164
	Adaptor for reception of 200 gram Omni Fit or Sicomet tubes	
	Connection adaptor for threads of 310 ml Euro cartridges with PG 9 inner thread	39522704
	Screw connection PG 9 with anti-kink protection for hose Ø 6/8 mm	417804084
	Product hose Ø 6/8 mm material: PTFE	417400224
	Product hose Ø 6/8 mm material: transparent PE	417400310
	310 ml empty cartridge	416018402