

Double Containment System
CONTAIN-IT Plus
metric

Product Range 2004



+GF+

40 Years of Application Know-How



Our long experience in plastic piping systems applications is also for your security. Approvals and third-party controls are the guarantee for continuously

high quality. Many of our products have the necessary approvals of the relevant institutes and thanks to the batch identification they are traceable.

Fields of applications

Our specialists are proving their wide material knowledge and their application experience day by day in various industries:

- Water treatment
- Galvanics
- Automotive industry
- Cellulose and paper industry
- Textile industry
- Museums/Archives
- Waste water technical asset, with pollutant ingredients
- Waste water systems in water protection areas
- Battery production
- Chemical industry
- Semiconductor industry/printed circuit board production
- Waste water treatment/waste combustion
- Generating plant
- Metal processing/betterment
- Disposal drainage
- Life Science

Do you miss your application in the above list? No problem. Please call us, and we will find a solution according to your specifications.

Quality Products with Advantages



Advantage of Wide Product Ranges

Fittings
Hand-Operated Valves
Pipes
Jointing Systems
Actuated Valves
Measure and Control Technology
Machines and Tools
 available in ISO/DIN



Quality management system certified according to ISO 9001/EN 29001 and ISO 14001



Advantage of Quality

Compound
 Our own compound and strict quality controls for each raw material delivery form the basis for Georg Fischer's high-quality products.

Production Know-How
 Due to know-how gathered over 40 years we are able to produce our products to exceptionally high tolerances.



Advantage of Ecology

In the line with the ISO 14001 certification the environmental risks get systematically analysed and if necessary arrangements get discharged to minimise them. Modern large concerns demand analysis of the deliverers and Georg Fischer supports that actively. Most of our companies are already successfully certificated or the process of certification is in progress.

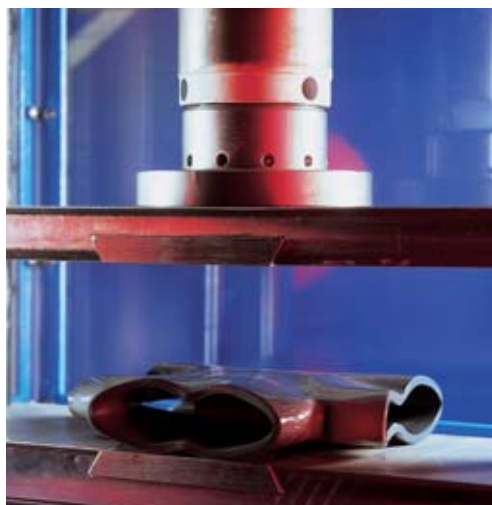

Advantage of Production Quality Control Tests

The double containment system consists of standard single components, which come under different component scrutiny.

- Pressure Pulsation Testing 100 h Test
- Chemical Resistance
- Functions
- Temperature Cycling Test
- Cyclic Bending Test

Accredited laboratory for components of plastic piping systems according to SN EN ISO 45001

for Professional Users

Advantage in Planning

Many customers prefer to purchase the complete piping system from one supplier. Because only systems that are designed to complement each other guarantee easy planning, installing and efficient functioning of the piping system. The calculation of the piping system will be made with the most modern calculation program.

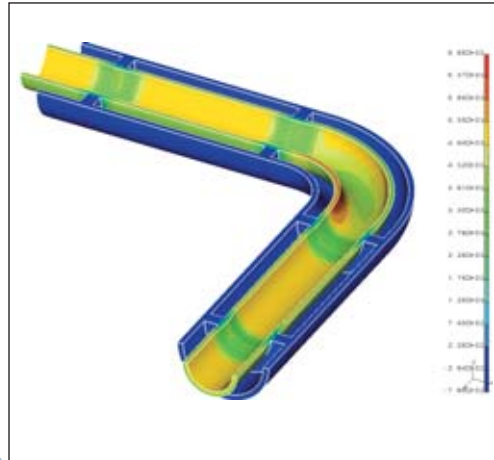

Up-to-date know-how

+GF+ DIGICAT
CD-ROM catalogue

Online catalogue
www.piping.georgfischer.com



Advantage of Choosing the Right Material

For maximum safety and optimal durability of a piping system the choice of raw material and pressure class of the pipe parts is highly important. The raw material's suitability to the medium can be checked with the help of our chemical resistance list.



Advantage of Jointing Technology

The patented Double Containment jointing technology enables to connect the double pipeline to be joined similarly to a single pipeline with stringent adherence to DVS guidelines. Thereby "blind fusions" are avoided. This kind of connection allows a pressure control on the inner pipe.

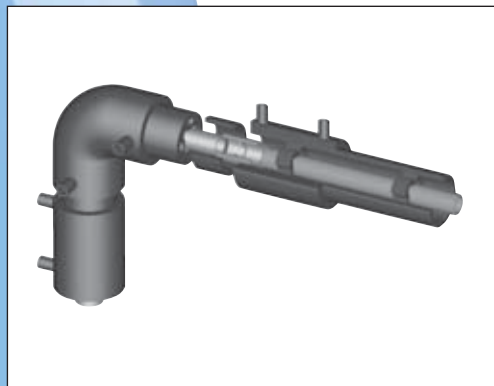

Advantage of Support

Training

Georg Fischer offers training possibilities at our regional sales companies, in our own training center in Schaffhausen or at your premises.

Worldwide Distribution

Sales companies, representatives and dealers from Georg Fischer can supply you with complete technical advice, punctual distribution and fast service in almost every corner of the world.



Contents

	Page
System description	6
Calculation chart	7
Questionnaire for Static Evidence of Secondary Containment Systems	8
Overview product range	9
Pressure Temperature Diagram / Abbreviation	11
Outer pipes and accessories for all inner pipes	12
Leak detection	17
Double containment fitting, ball valve and inner pipe PVC-U/PE 100	19
Double containment fitting, ball valve and inner pipe PVC-C/PE 100	23
Double containment fitting, ball valve and inner pipe PE/PE 100	27
Double containment fitting, ball valve and inner pipe PP-H/PE 100	34
Double containment fitting, ball valve and inner pipe PVDF/PE 100	42
Tools, machines and accessories	49
Cement / Cleaner	53

Double Containment – Contain-IT Plus

Double containment from Georg Fischer are a safe means of transport for all dangerous fluidities, that can damage our environment, people or plant components if they leak uncontrolled.

The inner pipe is available in all plastic materials from Georg Fischer, thereby ideal basic material range concerning chemical resistance. For the outer pipe there can alternatively be used a **pressure-resistant** (up to 16 bar) PE-pipe, that gets reweld with ELGEF Plus electrofusion socket, or a thin-walled PVC-U pipe, transparent or grey. The PVC-U outer pipe and the double containment fitting of PE 100 material will be linked with a EPDM coupler (splash guard up to 1 bar) over which a V2A-strap is laid.

The following criteria are significant for safe operation:

Separate connections of inner and outer pipes, thereby control of fusion or cementing connection in compliance with the DVS fusion commandments and solvent instructions of the KRV.

Pressure test of the ready-made inner pipes before locking the outer pipe, thereby leakage of the inner pipe immediately visible, trouble-free location of leakage.

Arrangement of the outer pipe with the endfitting in leak sections, thereby containment of the leaking fluidity in case of loss and easier location of leakage. For pipelines in the ground with overpressure leak indication this is an alternative solution to the leak indication locating cable.

Minimal dimension differences between inner and outer pipe, thereby smaller outer pipe, smaller electrofusion socket, smaller pipe clamps, less required space, lower installation complexity.

Inner pipe gets pushed into the outer pipe with clamped distance retainers, no precast double containment, pipe also useable as single pipe.

Converting to a large extend with standard fusion machines.

Single relocation of double containment to inapproachable places, in ducts and on ceilings by toolless connection with solvent cementing inner pipe.

Assembling anchor with static evidence, the occurring powers and stresses will be calculated by Georg Fischer, if desired, and held to bend, t-pieces and fittings by **anchor pipe clamps**. The anchor for the inner pipe is already assembled in every fitting with support rings. The operation conditions as for example pressure, temperature, medium are asked by the questionnaire "static evidence", if the calculated stresses on the pipe are too big, the operation conditions or the basic material have to be changed maybe.

The circumference in the piping system course has not to be regarded, no added circumferenced bends and flexible section necessary.

Calculation chart

Calculation of socket equal / snap ring /
ELGEF Plus electrofusion socket or EPDM couplers

Needed number of pieces → /per	Socket equal	Snap ring	ELGEF Plus electro- fusion socket for pressure-resistant outer pipe	EPDM rubber coupler for splash proof
Socket fusion/Solvent				
Elbow 90°	1	2	2	2
Elbow 45°	1	2	2	2
T 90°	2	3	3	3
Endfitting	0 (1**)	1 (2**)	1 (2**)	1 (2**)
Butt fusion				
Elbow 90°	0	2	2	2
Elbow 45°	0	2	2	2
T 90°	0	3	3	3
Endfitting	0 (1**)	1 (2**)	1 (2**)	1 (2**)
Inner pipe	*	0	0	0
Outer pipe	0	0	*	*

* 1 piece per manufactured pipe

** for segmentation of pipeline into leak detection sections

Fittingtypes for solvent cementing and socket fusion

Fittingtype: CONTAIN-IT Plus
Solvent cementing and socket fusion HD

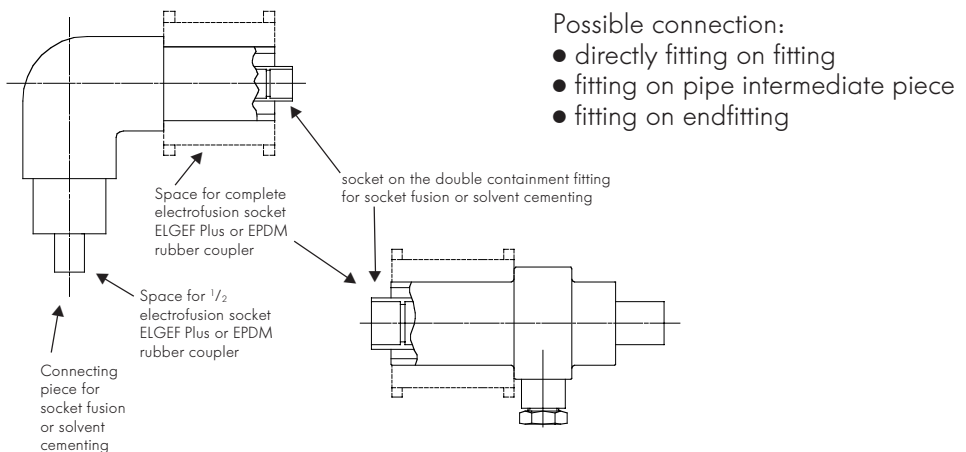

Fittingtypes for butt fusion

Fittingtype: CONTAIN-IT Plus
Butt fusion HS

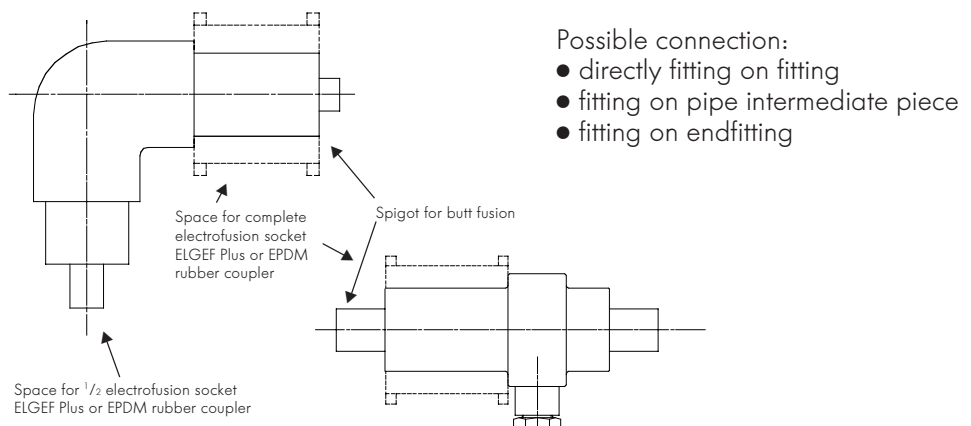

Questionnaire for Static Evidence of Secondary Containment Systems

General project information	
Project / Object = File name	_____
Order placed by / Customer	_____
Bid / Order number	_____

Materials selection for outer pipe*	PE 80	PE 100	PVC-U
	<input type="checkbox"/>	<input type="checkbox"/>	<input type="checkbox"/>

Leak detection information Type of monitoring*	optical	N ₂	Cable	Other
	<input type="checkbox"/>	<input type="checkbox"/>	<input type="checkbox"/>	
Overpressure difference [bar]				
Underpressure [mbar]				
No pressure*	<input type="checkbox"/>			

Additional system data*	Installation location 1		Installation location 2	
	Above ground <input type="checkbox"/>	In the ground <input type="checkbox"/>	In buildings <input type="checkbox"/>	Outdoors <input type="checkbox"/>
Time period for temperature change:	_____		_____	
Ambient temperature:	Max. _____ Min. _____	Max. _____ Min. _____		
Installation temperature:	Max. _____ Min. _____	Max. _____ Min. _____		

Selection of Secondary Containment components				
Type of fittings required*	<input type="checkbox"/> 90° elbow	<input type="checkbox"/> 45° elbow	<input type="checkbox"/> T-equal	<input type="checkbox"/> T-red
Inner pipe:			Outer pipe:	
Material	_____		Material	
Nominal diameter DN	_____		Nominal diameter DN	
Outer diameter d	_____		Outer diameter d	
Wall thickness e	_____		Wall thickness e	
Nominal pressure rating PN	_____		Nominal pressure rating PN	
Standard dimension ratio SDR	_____		Standard dimension ratio SDR	

Joining technology	HS	HD	IR	KL	HM	GM	HS = Butt fusion HD = Socket fusion IR = Infrared KL = Cementing HM = Electrofusion GM = EPDM coupler	
	Inner pipe*	<input type="checkbox"/>	<input type="checkbox"/>	<input type="checkbox"/>	<input type="checkbox"/>			
	Outer pipe*					<input type="checkbox"/>		<input type="checkbox"/>

Operating Conditions	
Flow media / Concentration _____	Density: _____ g/cm ³
Maximum working temperature _____ °C	In percent _____ %
Minimum working temperature _____ °C	In percent _____ %
Maximum working pressure _____ bar	In percent _____ %
Minimum working pressure _____ bar	In percent _____ %
Required service life * (years)	10 <input type="checkbox"/> 25 <input type="checkbox"/> 50 <input type="checkbox"/>

* Please mark if applicable

Overview Product Range

Dimension d x D	Inner pipe										
	Solvent cementing				Socket fusion			Butt-/IR-fusion			
	PVC-U Tangit	PVC-U Dytex	PVC-C Tangit	PVC-C Dytex	PP-H	PE 80	PVDF Standard	PP-H ISO S5 SDR 11	PE 100 ISO S5 SDR 11	PVDF Standard PN 16	PVDF Standard PN 10
20 x 50	▲	▲	▲	▲	▲	▲	▲	☼	☼	☼	
25 x 50	▲	▲	▲	▲	▲	▲	▲	☼	☼	☼	
32 x 63	▲	▲	▲	▲	▲	▲	▲	☼	☼	☼	
40 x 75	▲	▲	▲	▲	▲	▲	▲	▲	▲	▲	
50 x 90	▲	▲	▲	▲	▲	▲	▲	▲	▲	▲	
63 x 110	▲	▲	▲	▲	▲	▲	▲	☼	☼	☼	
75 x 125	▲	▲	▲	▲	▲	▲	▲	☼	☼	☼	
90 x 140	▲	▲	▲	▲	▲	▲	▲	☼	☼	☼	
110 x 160	▲	▲	▲	▲	▲	▲	▲	☼	☼	☼	
125 x 180	▲							▲	▲		▲
140 x 200	▲							▲	▲		▲
160 x 225	▲							▲	▲		▲
200 x 280	▲							▲	▲		▲
225 x 315	▲							▲	▲		▲

☼ = Butt- and Infrared-(IR-Plus®) compatible

Nominal pressure PN (also known as pressure rate) isn't enough anymore

The common use of PN almost all over the world as designation of the pipe dimension holds huge danger of confusion when butt fusing. An attempt for pipes and fittings of plastic was achieved, to use pressure uncommitted descriptions for pipes and fittings with the same pressure capacity. This is to avoid a mistakable use of pipes in different fields of application or under different conditions.

According to ISO 4065 the pipes are divided in series, whereby pipes with the same serial number accept the same capacity, as it is also comparatively with descriptions according nominal pressure rate. The pipe series is signed with the letter S.

For a PP-pipe with admeasurement 110 x 10 mm it makes:

$$S = 5 = (110 - 10) / (2 * 10)$$

Furthermore the description SDR is also known, whereby SDR stands for Standard Dimension Ratio. SDR gives the bore-/ wall thickness ratio.

$$SDR = \frac{d}{e}$$

Serial- and SDR description are linked by the formula:

$$SDR = 2 * S + 1$$

Referring to the example mentioned before it follows:

$$SDR = 110/10 = 11 = 2 * 5 + 1$$

At the moment there are all three descriptions in market, namely PN, S and SDR.

We therefore recommend to always give dimension and wall thickness as well as pipe serial or SDR.

The following pressure-temperature-diagrams are based on an operating life of 25 years.

Safety factors at variance with these and modified operational lifetime necessitate separate calculations.

Pressure-Temperature-Diagram

Application Limits of Pipes and Fittings made of PE100 (Eltex TUB121®, CRP 100®)

(25 years operation with design-factor = 1,6 or 1,25 incorporated; medium water or similar media)

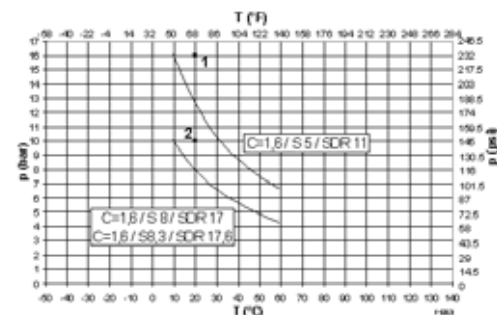

- 1 Design Factor C= 1,25 / S 5 / SDR 11 for 20 °C water / 50 years
- 2 Design Factor C= 1,25 / S 8,3 / SDR 17,6 and S 8 / SDR 17 for 20 °C water / 50 years
- T Temperature in °C / °F
- p permissible pressure in bar / psi

Application Limits of Pipes and Fittings made of PE80

(25 years operation with design-factor = 1,6)

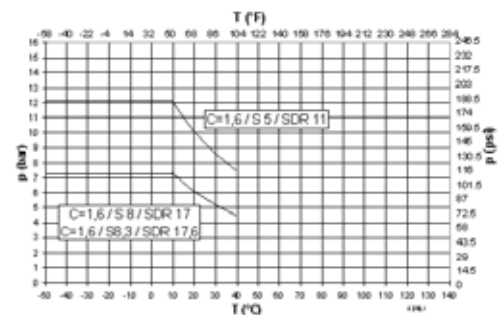

- P permissible pressure in bar / psi
T Temperature in °C / °F

Application Limits of Pipes and Fittings made of PP-H

(25 years operation with design-factor = 2,0 incorporated; medium water or similar media)

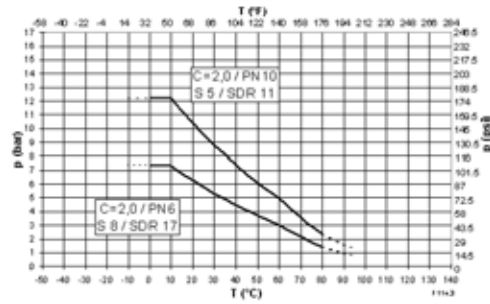

T Temperature in °C / °F
p permissible pressure in bar / psi

Application Limits of Pipes and Fittings made of PVDF

(medium water or similar media)

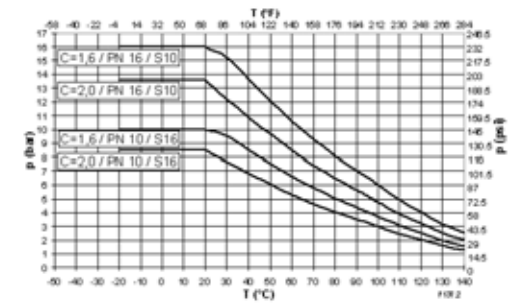

T Temperature in °C / °F
p permissible pressure in bar / psi

Application Limits of Pipes and Fittings made of PVC-U

(25 years operation with design-factor = 2,5 incorporated; medium water or similar media)

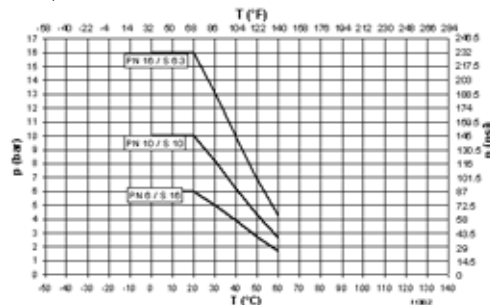

T Temperature in °C / °F
p permissible pressure in bar / psi

Application limits of pipes and fittings made of PVC-C

(25 years operation with design-factor incorporated; medium water or similar media)

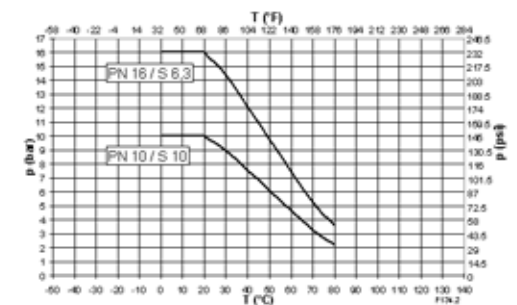

T Temperature in °C / °F
p permissible pressure in bar / psi

The pressure-temperature-diagrams mentioned above for pipes and fittings are designed to have a useful life of 25 years. Digressing design factors or a changed useful life make an individual calculation necessary.

List of abbreviations

ANSI	American National Standard Institute	DN	Nominal width
ASTM	American Society for Testing and Materials	PN	Nominal pressure at 20°C, water
BS	British Standard	kg	Weight in kilograms
DIN	Deutsche Industrie Normen	g	Weight in grams
ISO	International Standardization Organisation	SP	Standard pack. The figure given indicates the quantity fittings contained in a standard pack
ABS	Acrylonitrile-Butadien-Styrene	GP	Gross pack. The figure given indicates the quantity of fittings contained in a gross pack
PVC-U	Polyvinyl Chloride	G	Pipe thread, not pressure tight in the thread to ANSI B 1.20.1
PVC-C	Polyvinyl Chloride chlorinated	NPT	Taper male thread pressure tight in the thread to ANSI B 1.20.1
PP	Polypropylene, heat stabilised	R	Taper male thread, pressure tight in the thread to ISO 7/DIN 2999/1
PE	Polyethylene	Rc	Taper female thread, pressure tight in the thread to ISO 7/1
PVDF	Polyvinylidene fluoride	Rp	Parallel female thread, pressure tight in the thread to ISO 7/DIN 2999/1
EPDM	Ethylene-Propylene-Rubber	Tr	Trapezoid thread
FPM	Fluoric-Rubber e.g. Viton®	SC	Size of hexagon bolts
NBR	Nitrile-Rubber	s	A/F
PTFE	Polytetrafluorethylene, e.g. Teflon®	e	Wall thickness
PBTP	Polybutylene terephthalate	AL	Number of bolt holes
UP-GF	Unsaturated polyester resin, glassfibre reinforced	®	Registered trade-mark
St	Steel		
d	Pipe outside diameter		
HD	Socket fusion		
HS	Butt fusion		
SDR	Wall thickness relation		
S	Pipe category		
SM	Fusion method		

Outer pipes and accessories for all inner pipes

Pipes

93 01 71

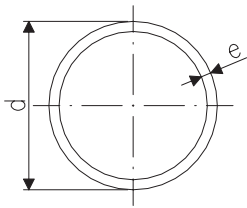

Containment pipes, PE100 S5/SDR11

Model:

- Material: PE 100, Polyethylene
- Colour: RAL 9011 graphite black
- Dimension: DIN 8074
- Pipe lengths: 5m, with plain ends

d	PN	Matching to inner pipe d	Code	e
50	16	20; 25	193 017 160	4,6
63	16	32	193 017 161	5,8
75	16	40	193 017 162	6,8

93 01 71

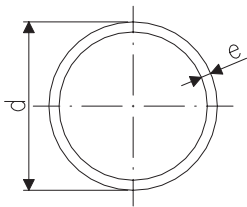

Containment pipes, PE100 S8,3/SDR17,6

Model:

- Material: PE 100, Polyethylene
- Colour: RAL 9011 graphite black
- Dimension: DIN 8074
- Pipe lengths: 5m, with plain ends

d	PN	Matching to inner pipe d	Code	e
90	10	50	193 017 113	5,1
110	10	63	193 017 114	6,3
125	10	75	193 017 115	7,1
140	10	90	193 017 116	8,0
160	10	110	193 017 117	9,1
180	10	125	193 017 118	10,2
200	10	140	193 017 119	11,4
225	10	160	193 017 120	12,8
280	10	200	193 017 122	15,9
315	10	225	193 017 123	17,9

Containment pipes, PVC-U

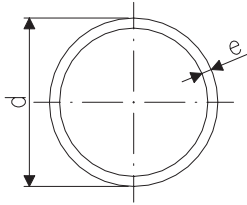

Model:

- Material: PVC-U, Polyvinyl Chloride Unplasticised DIN 8061
- Colour: RAL 7011 – dark-grey
- Dimension: DIN 8062
- Pipe lengths: 5m, with plain ends

d	PN	Matching to inner pipe d	Code	e
50	16	20; 25	161 017 110	3.7
63	16	32	161 017 111	4.7
75	10	40	161 017 087	3.6
90	10	50	161 017 088	4.3
110	10	63	161 017 089	5.3
125	6	75	161 017 065	3.7
140	6	90		
160	6	110		
180	6	125		
200	6	140		
225	6	160		
280	4	200		
315	4	225		

Containment Pipes PVC-U transparent

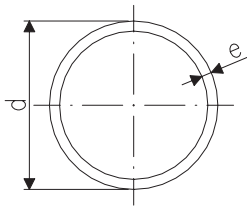

Model:

- Material: PVC-U, Polyvinyl Chloride Unplasticised DIN 8061
- Colour: transparent
- Dimension: DIN 8062
- Pipe lengths: 5m, with plain ends

d	PN	Matching to inner pipe d	Code	e
50	16	20; 25	192 017 110	3.7
63	16	32	192 017 111	4.7
75	10	40	192 017 087	3.6
90	10	50	192 017 088	4.3
110	10	63	192 017 089	5.3
125	6	75		
140	6	90		
160	6	110		
180	6	125		
200	6	140		
225	6	160		
280	4	200		
315	4	225		

Coupler ELGEF

Connection for outer pipe

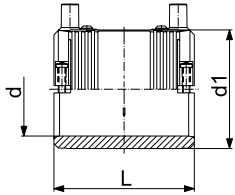

d	SDR	PN	Code	d1	L
50	11	16	753 911 610	66	88
63	11	16	753 911 611	81	96
75	11	16	753 911 612	96	110
90	11	16	753 911 613	113	125
110	11	16	753 911 614	138	145
125	11	16	753 911 615	154	158
140	11	10	753 911 616	172	168
160	17	10	753 911 817	186	180
180	17	10	753 911 818	202	190
200	17	10	753 911 819	224	202
225	17	10	753 911 820	252	220
280	17	10	753 911 822	340	252
315	17	10	753 911 823	360	271

Coupler EPDM

Connection for outer pipe

- leak tight up to 1 bar

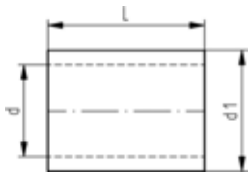

d	PN	Code	d1	L
50	1	700 238 444	66	85
63	1	700 238 445	80	85
75	1	700 238 446	93	85
90	1	700 238 447	110	85
110	1	700 238 448	130	125
125	1	700 238 449	145	125
140	1	700 238 450	160	125
160	1	700 238 451	180	125
180	1	700 238 452	200	125
200	1	700 238 453	220	125
225	1	700 238 454	245	125
280	1	700 238 456	300	150
315	1	700 238 457	335	150

Sockets equal, PVC-U

21 91 01

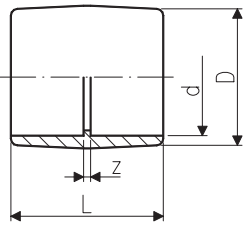

d	PN	Code	z	D	L
50	16	721 910 110	3	58	65
63	16	721 910 111	3	73,4	79
75	16	721 910 112	4	87,2	92
90	16	721 910 113	5	105	107
110	16	721 910 114	6	127,5	128
125	16	721 910 115	7	142	145
140	16	721 910 116	7	162	159
160	16	721 910 117	8	183	180
200	10	721 910 119	9	221	221
225	10	721 910 120	10	253	248
280	10	721 910 122	16	321	314
315	10	721 910 123	16	356	348

Snap ring PE

For closing the gap in the outer pipe



d	Code	e	B
50	700 238 424	4.6	30
63	700 238 425	5.8	30
75	700 238 426	6.9	30
90	700 238 427	5.1	30
110	700 238 428	6.3	30
125	700 238 429	7.1	30
140	700 238 430	8.0	30
160	700 238 431	9.1	30
180	700 238 432	10.2	30
200	700 238 433	11.4	30
225	700 238 434	12.8	30
280	700 238 436	15.9	30
315	700 238 437	17.9	30

Spacers

To center the medium pipe within the outer pipe

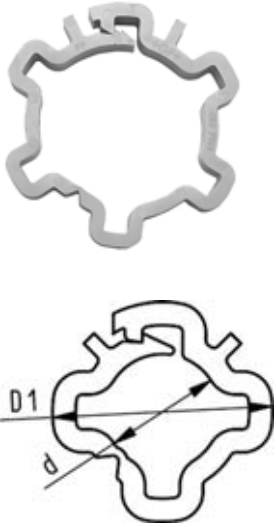

d	D1	Code	B	Matching to outer pipe PVC-U	Matching to outer pipe PE
20	38	700 238 060	15	d50 x 3,7 (PN16)	d50 x 4,6 (SDR11)
25	38	700 238 061	20	d50 x 3,7 (PN16)	d50 x 4,6 (SDR11)
32	48	700 238 062	20	d63 x 4,7 (PN16)	d63 x 5,8 (SDR11)
40	57	700 238 043	25	d75 x 3,6 (PN10)	d75 x 6,9 (SDR11)
50	76	700 238 064	25	d90 x 4,3 (PN10)	d90 x 5,1 (SDR17.6)
63	94	700 238 065	25	d110 x 5,3 (PN10)	d110 x 6,3 (SDR17.6)
75	104	700 238 046	30	d125 x 3,7 (PN6)	d125 x 7,1 (SDR17.6)
90	118	700 238 047	30	d140 x 4,1 (PN6)	d140 x 8,0 (SDR17.6)
110	138	700 238 068	35	d160 x 4,7 (PN6)	d160 x 9,1 (SDR17.6)
125	152	700 238 049	35	d180 x 5,3 (PN6)	d180 x 10,2 (SDR17.6)
140	173	700 238 070	35	d200 x 5,9 (PN6)	d200 x 11,4 (SDR17.6)
160	195	700 238 071	35	d225 x 6,6 (PN6)	d225 x 12,8 (SDR17.6)
200	238	700 238 053	40	d280 x 5,5 (PN4)	d280 x 15,9 (SDR17.6)
225	267	700 238 054	40	d315 x 6,2 (PN4)	d315 x 17,9 (SDR17.6)

Foil roll

g		Code
210	Rolle PE-Stretchfolie	799 198 041

Leak Detection

Branch Saddle

Mounting fixture for leak detection system at outer pipe.

53 131 000

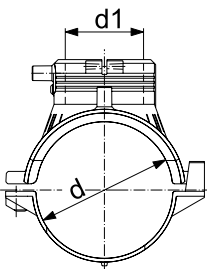

L = length / Länge

** not suitable for all tapping-tee, tapping-valve and spigot with cutter of the modular systems / delivery without lower part for assembling as Top load with tool 799.350.368

d-d1	Code	L
63-63	193 131 037	165
75-63	193 131 047	165
90-63	193 131 057	165
110-63	193 131 067	165
125-63	193 131 077	165
140-63	193 131 087	165
160-63	193 131 097	165
180-63	193 131 107	165
200-63	193 131 117	165
225-63	193 131 127	165
280-63**	193 131 147	165
315-63**	193 131 157	165

Adapter for branch saddle



d	Code
63 x 1/2"	700 238 300

21 91 07

Bushes equal, PVC-U

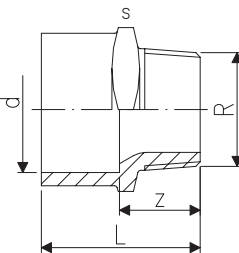

Model:

- With solvent cement socket ISO/DIN and taper male thread R
- Connection to plastic thread
- Do not use thread sealing pastes that are harmful to PVC-U

d-R	PN	Code	z	L	s
20-1/2"	16	721 910 706	24	40	32

Branch Saddle with reinforcement ring

Incl. O-ring seal NBR

B = No. of bolts

M = bolt type

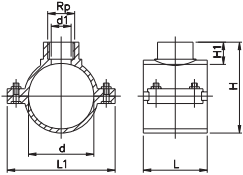

d-Rp	PN	Code	d1	L	L1	H	H1	B	M
50- 1/2"	10	700 627 393	20,5	62	86	82	20	2	M 8x40
63- 1/2"	10	700 627 396	18	62	101	96	21	4	M 8x40
75- 1/2"	10	700 627 401	16	79	123	102	14	4	M 8x60
90- 1/2"	10	700 627 407	16	87	138	116	14	4	M 8x60
110- 1/2"	10	700 627 413	15	99	152	150	23	4	M 8x50
125- 1/2"	10	700 627 419	15	101	166	168,5	23,5	4	M 8x50
140- 1/2"	6	700 627 426	18	114	207	191	25	4	M 8x70
160- 1/2"	6	700 627 432	18	114	226	215	24	4	M 8x70

Ball Valve Type 546, PVC-U with solvent cement spigots, metric

Model:

- Union type ends for easy installation and removal
(z-dimension, valve end and valve nut are **not compatible** with Type 346)
- Ball seals PTFE
- Without mounting inserts

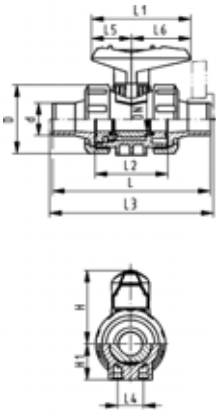

d	DN	PN	kv-value l/ min ($\Delta p=1$ bar)	EPDM Code
20	15	16	185	161 546 042

d	D	H	H1	L	L1	L2	L3	L4	L5	L6
20	50	57	26,5	124	77	56	130	25	32	45

Monitoring pipe PVC-U, transparent

for ball valve Type 546

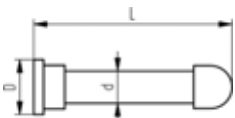

d	Code	L	D
20	700 244 652	110	38

Double Containment Fitting PVC-U / PE100

Connection of inner pipe by socket cementing

Elbows 90° PVC-U / PE100

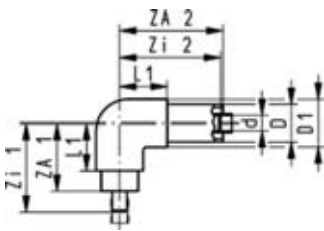

d x D	PN	PVC-U Tangit / PE Code	PVC-U Dytex / PE Code	ZA 1	ZA 2	L1	Zi 1	Zi 2	D1
20 x 50	16/ 16	721 104 106	721 104 156	105	175	71	139	174	66
25 x 50	16/ 16	721 104 107	721 104 157	105	175	71	142	171	66
32 x 63	16/ 16	721 104 108	721 104 158	120	190	81	160	183	81
40 x 75	16/ 16	721 104 109	721 104 159	145	225	101	189	214	97
50 x 90	16/ 10	721 104 110	721 104 160	160	250	110	209	234	113
63 x 110	16/ 10	721 104 111	721 104 161	195	290	132	251	267	136
75 x 125	16/ 10	721 104 112	721 104 162	210	315	142	273	286	151
90 x 140	16/ 10	721 104 113	721 104 163	250	360	178	321	324	196
110 x 160	16/ 10	721 104 114	721 104 164	260	375	178	342	329	196
125 x 180	16/ 10	721 104 115							
140 x 200	16/ 10	721 104 116							
160 x 225	16/ 10	721 104 117							
200 x 280	10/ 10	721 104 119							
225 x 315	10/ 10	721 104 120							

Elbows 45° PVC-U / PE100

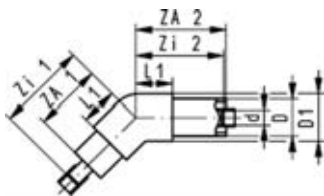

d x D	PN	PVC-U Tangit/ PE Code	PVC-U DYTEX/ PE Code	ZA 1	ZA 2	L1	Zi 1	Zi 2	D1
20 x 50	16/ 16	721 154 106	721 154 156	105	175	56	139	174	66
25 x 50	16/ 16	721 154 107	721 154 157	105	175	56	142	171	66
32 x 63	16/ 16	721 154 108	721 154 158	120	190	63	160	183	81
40 x 75	16/ 16	721 154 109	721 154 159	145	225	79	189	214	97
50 x 90	16/ 10	721 154 110	721 154 160	160	250	52	209	234	112
63 x 110	16/ 10	721 154 111	721 154 161	195	290	103	251	267	136
75 x 125	16/ 10	721 154 112	721 154 162	210	315	107	273	286	151
90 x 140	16/ 10	721 154 113	721 154 163	250	360	134	321	324	196
110 x 160	16/ 10	721 154 114	721 154 164	260	375	134	342	329	196
125 x 180	16/ 10	721 154 115							
140 x 200	16/ 10	721 154 116							
160 x 225	16/ 10	721 154 117							
200 x 280	10/ 10	721 154 119							
225 x 315	10/ 10	721 154 120							

T90° equal PVC-U / PE100

Tee 45° on request

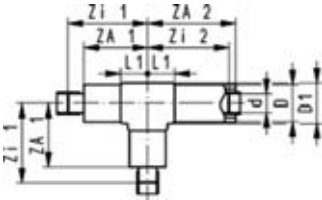

d x D	PN	PVC-U Tangit / PE Code	PVC-U Dytex / PE Code	ZA 1	ZA 2	L1	Zi 1	Zi 2	D1
20 x 50	16/ 16	721 204 106	721 204 156	105	175	42,5	139	174	54
25 x 50	16/ 16	721 204 107	721 204 157	105	175	42,5	142	171	54
32 x 63	16/ 16	721 204 108	721 204 158	120	190	50	160	183	67
40 x 75	16/ 16	721 204 109	721 204 159	145	225	61	189	214	79
50 x 90	16/ 10	721 204 110	721 204 160	160	250	70,5	209	234	101
63 x 110	16/ 10	721 204 111	721 204 161	195	290	80	251	267	119
75 x 125	16/ 10	721 204 112	721 204 162	210	315	90,5	273	286	134
90 x 140	16/ 10	721 204 113	721 204 163	250	360	108	321	324	170
110 x 160	16/ 10	721 204 114	721 204 164	260	375	108	342	329	170
125 x 180	16/ 10	721 204 115							
140 x 200	16/ 10	721 204 116							
160 x 225	16/ 10	721 204 117							
200 x 280	10/ 10	721 204 119							
225 x 315	10/ 10	721 204 120							

Termination fitting PVC-U / PE100

Sealing in body EPDM

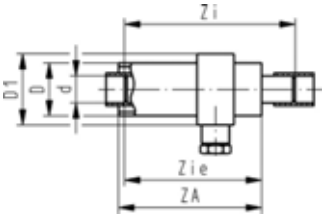

d x D	PN	PVC-U Tangit / PE Code	PVC-U Dytex/ PE Code	ZA	Zi	Zie	D1
20 x 50	16/ 10	721 964 106	721 964 156	175	208	174	70
25 x 50	16/ 10	721 964 107	721 964 157	175	208	171	70
32 x 63	16/ 10	721 964 108	721 964 158	185	218	178	80
40 x 75	16/ 10	721 964 109	721 964 159	205	238	194	90
50 x 90	16/ 10	721 964 110	721 964 160	250	283	234	110
63 x 110	16/ 10	721 964 111	721 964 161	270	303	247	130
75 x 125	16/ 10	721 964 112	721 964 162	290	324	261	140
90 x 140	16/ 10	721 964 113	721 964 163	310	345	274	160
110 x 160	16/ 10	721 964 114	721 964 164	330	366	284	170
125 x 180	16/ 10	721 964 115					
140 x 200	16/ 10	721 964 116					
160 x 225	16/ 10	721 964 117					
200 x 280	10/ 10	721 964 119					
225 x 315	10/ 10	721 964 120					

Double Containment Ball Valve

Inner pipe PVC-U Tangit/Outer pipe PE

Ball Valve Type 346, PVC-U

Connections for solvent cementing with Tangit

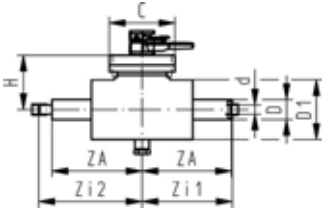

Model:

- Manual operated
- Manual override with ratchet setting
- Retrofit with an electric or pneumatic actuator unit
- Radial installation and removal possible
- Protection housing PE PN6

d x D	PN	EPDM Code	FPM Code	ZA	Zi 1	Zi 2	Ø C	D1	H
20 x 50	16/6	700 238 800	700 238 806	235	234	269	151	170	152
25 x 50	16/6	700 238 801	700 238 807	235	231	272	151	170	152
32 x 63	16/6	700 238 802	700 238 808	240	233	280	151	170	152
40 x 75	16/6	700 238 803	700 238 809	290	279	334	196	215	201
50 x 90	16/6	700 238 804	700 238 810	305	289	354	196	215	201
63 x 110	16/6	700 238 805	700 238 811	335	312	391	225	235	221

Inner pipe PVC-U Dytex/Outer pipe PE

Ball Valve Type 346, PVC-U

Connections for solvent cementing with Dytex

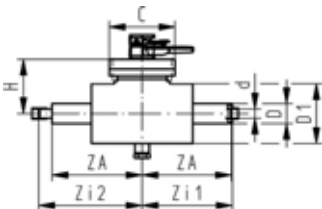

Model:

- Manual operated
- Manual override with ratchet setting
- Retrofit with an electric or pneumatic actuator unit
- Radial installation and removal possible
- Protection housing PE PN6

d x D	PN	EPDM Code	FPM Code	ZA	Zi 1	Zi 2	Ø C	D1	H
20 x 50	16/6	700 238 812	700 238 818	235	234	269	151	170	152
25 x 50	16/6	700 238 813	700 238 819	235	231	272	151	170	152
32 x 63	16/6	700 238 814	700 238 820	240	233	280	151	170	152
40 x 75	16/6	700 238 815	700 238 821	290	279	334	196	215	201
50 x 90	16/6	700 238 816	700 238 822	305	289	354	196	215	201
63 x 110	16/6	700 238 817	700 238 823	335	312	391	225	235	221

Inner pipe and connection elements PVC-U

Medium pipes PVC-U, grey

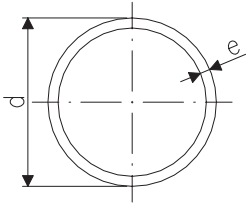

Model:

- Material: PVC-U, Polyvinyl Chlorid unplasticised DIN 8061
- Colour: RAL 7011 - dark-grey
- Dimension: DIN 8062
- Pipe length: 5m, with plain ends

d	PN	Code	e
20	16	161 017 106	1.5
25	16	161 017 107	1.9
32	16	161 017 108	2.4
40	16	161 017 109	3.0
50	16	161 017 110	3.7
63	16	161 017 111	4.7
75	16	161 017 112	5.6
90	16	161 017 113	6.7
110	16	161 017 114	8.1
125	16	161 017 115	9.2
140	16	161 017 116	10.3
160	16	161 017 117	11.8
200	10	161 017 094	9.6
225	10	161 017 095	10.8

21 91 01

Sockets equal, PVC-U

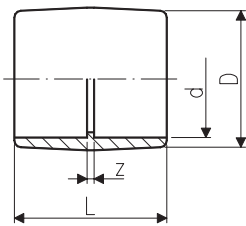

d	PN	Code	z	D	L
20	16	721 910 106	3	26	35
25	16	721 910 107	3	31,5	41
32	16	721 910 108	3	39,2	47
40	16	721 910 109	3	48	55
50	16	721 910 110	3	58	65
63	16	721 910 111	3	73,4	79
75	16	721 910 112	4	87,2	92
90	16	721 910 113	5	105	107
110	16	721 910 114	6	127,5	128
125	16	721 910 115	7	142	145
140	16	721 910 116	7	162	159
160	16	721 910 117	8	183	180
200	10	721 910 119	9	221	221
225	10	721 910 120	10	253	248

Double Containment Fitting PVC-C / PE100

Connection of inner pipe by socket cementing

Elbow 90° PVC-C / PE100

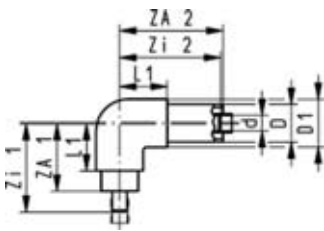

d x D	PN	PVC-C Tangit/ PE Code	PVC-C Dytex/ PE Code	ZA 1	ZA 2	L1	Zi 1	Zi 2	D1
20 x 50	16/ 16	723 104 106	723 104 156	105	175	71	139	174	66
25 x 50	16/ 16	723 104 107	723 104 157	105	175	71	142	171	66
32 x 63	16/ 16	723 104 108	723 104 158	120	190	81	160	183	81
40 x 75	16/ 16	723 104 109	723 104 159	145	225	101	189	214	97
50 x 90	16/ 10	723 104 110	723 104 160	160	250	110	209	234	113
63 x 110	16/ 10	723 104 111	723 104 161	195	290	132	251	267	136
75 x 125	16/ 10	723 104 112	723 104 162	210	315	142	276.5	286.5	151
90 x 140	16/ 10	723 104 113	723 104 163	250	360	178	321	324	196
110 x 160	16/ 10	723 104 114	723 104 164	260	375	178	343.5	326.5	196

Elbow 45° PVC-C / PE100

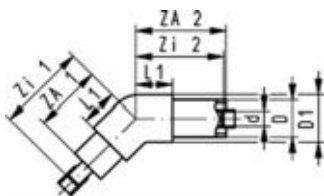

d x D	PN	PPVC-C Tangit/ PE Code	PVC-C Dytex/ PE Code	ZA 1	ZA 2	L1	Zi 1	Zi 2	D1
20 x 50	16/ 16	723 154 106	723 154 156	105	175	56	139	174	66
25 x 50	16/ 16	723 154 107	723 154 157	105	175	56	142	171	66
32 x 63	16/ 16	723 154 108	723 154 158	120	190	63	160	183	81
40 x 75	16/ 16	723 154 109	723 154 159	145	225	79	189	214	97
50 x 90	16/ 10	723 154 110	723 154 160	160	250	85	209	234	113
63 x 110	16/ 10	723 154 111	723 154 161	195	290	103	251	267	136
75 x 125	16/ 10	723 154 112	723 154 162	210	315	107	276.5	286.5	151
90 x 140	16/ 10	723 154 113	723 154 163	250	360	134	321	324	196
110 x 160	16/ 10	723 154 114	723 154 164	260	375	134	343.5	326.5	196

T90° equal PVC-C / PE100

T 45° on request

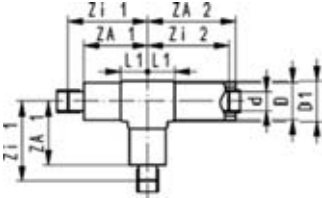

d x D	PN	PVC-C Tangit/ PE Code	PVPVC-C Dytex/ PE Code	ZA 1	ZA 2	L1	Zi 1	Zi 2	D1
20 x 50	16/ 16	723 204 106	723 204 156	105	175	42.5	139	174	54
25 x 50	16/ 16	723 204 107	723 204 157	105	175	42.5	142	171	54
32 x 63	16/ 16	723 204 108	723 204 158	120	190	50	160	183	67
40 x 75	16/ 16	723 204 109	723 204 159	145	225	61	189	214	79
50 x 90	16/ 10	723 204 110	723 204 160	160	250	70.5	209	234	101
63 x 110	16/ 10	723 204 111	723 204 161	195	290	80	251	267	119
75 x 125	16/ 10	723 204 112	723 204 162	210	315	90.5	276.5	286.5	134
90 x 140	16/ 10	723 204 113	723 204 163	250	360	108	321	324	170
110 x 160	16/ 10	723 204 114	723 204 164	260	375	108	343.5	326.5	170

Termination Fitting PVC-C / PE100

Sealing in body EPDM

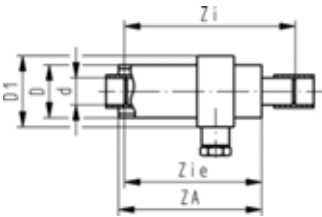

d x D	PN	PPVC-C Tangit/ PE Code	PVC-U Dytex/ PE Code	ZA	Zi	Zie	D1
20 x 50	16/ 10	723 964 106	723 964 156	175	208	174	70
25 x 50	16/ 10	723 964 107	723 964 157	175	208	171	70
32 x 63	16/ 10	723 964 108	723 964 158	185	218	178	80
40 x 75	16/ 10	723 964 109	723 964 159	205	238	194	90
50 x 90	16/ 10	723 964 110	723 964 160	250	283	234	110
63 x 110	16/ 10	723 964 111	723 964 161	270	303	247	130
75 x 125	16/ 10	723 964 112	723 964 162	290	324	261.5	140
90 x 140	16/ 10	723 964 113	723 964 163	310	345	274	160
110 x 160	16/ 10	723 964 114	723 964 164	330	365	281.5	170

Double Containment Ball Valve

Inner pipe PVC-C Tangit / Outer pipe PE

Ball Valve Type 346, PVC-C

Connections for solvent cementing with Tangit

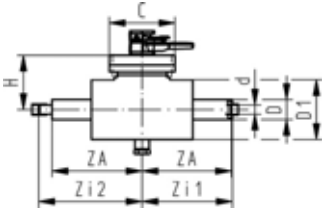

Model:

- Manual operated
- Manual override with ratchet setting
- Retrofit with an electric or pneumatic actuator unit
- Radial installation and removal possible
- Protection housing PE PN6

d x D	PN	EPDM Code	FPM Code	ZA	Zi 1	Zi 2	Ø C	D1	H
20 x 50	16/6	700 238 824	700 238 830	235	234	269	151	170	152
25 x 50	16/6	700 238 825	700 238 831	235	231	272	151	170	152
32 x 63	16/6	700 238 826	700 238 832	240	233	280	151	170	152
40 x 75	16/6	700 238 827	700 238 833	290	279	334	196	215	201
50 x 90	16/6	700 238 828	700 238 834	305	289	354	196	215	201
63 x 110	16/6	700 238 829	700 238 835	335	312	391	225	235	221

Inner pipe PVC-C Dytex / Outer pipe PE

Ball Valve Type 346, PVC-C

Connections for solvent cementing with Dytex

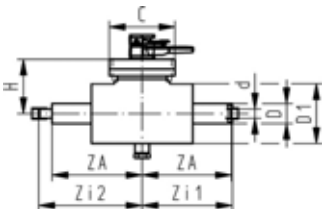

Model:

- Manual operated
- Manual override with ratchet setting
- Retrofit with an electric or pneumatic actuator unit
- Radial installation and removal possible
- Protection housing PE PN6

d x D	PN	EPDM Code	FPM Code	ZA	Zi 1	Zi 2	Ø C	D1	H
20 x 50	16/6	700 238 836	700 238 842	235	234	269	151	170	152
25 x 50	16/6	700 238 837	700 238 843	235	231	272	151	170	152
32 x 63	16/6	700 238 838	700 238 844	240	233	280	151	170	152
40 x 75	16/6	700 238 839	700 238 845	290	279	334	196	215	201
50 x 90	16/6	700 238 840	700 238 846	305	289	354	196	215	201
63 x 110	16/6	700 238 841	700 238 847	335	312	391	225	235	221

Inner pipe and connection elements PVC-C

Medium pipes PVC-C



Model:

Material: PVC-C
 Colour: RAL 7038 – aqate grey
 Dimension: DIN 8079
 Pipe length: 5m, with plain ends

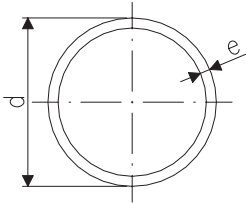

d	PN	Code	e
20	16	163 017 131	2,3
25	16	163 017 132	2,8
32	16	163 017 133	2,4
40	16	163 017 134	3,0
50	16	163 017 135	3,7
63	16	163 017 136	4,7
75	16	163 017 137	5,6
90	16	163 017 138	6,7
110	16	163 017 139	8,2

23 91 01

Sockets equal

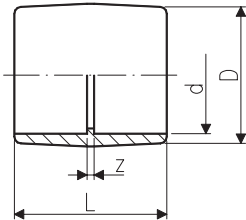

d	PN	Code	z	D	L
20	16	723 910 106	3	26	35
25	16	723 910 107	3	31	41
32	16	723 910 108	3	39	47
40	16	723 910 109	3	49	55
50	16	723 910 110	3	61	65
63	16	723 910 111	3	76	79
75	16	723 910 112	4	87	92
90	16	723 910 113	5	110	107
110	16	723 910 114	5	131	132

Double Containment Fitting PP-H / PE100

Connection of inner pipe by socket fusion (HD)

Elbow 90° HD PP-H / PE100

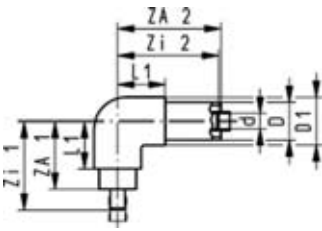

d x D	PN	Code	ZA 1	ZA 2	L1	Zi 1	Zi 2	D1
20 x 50	10/ 16	727 104 106	105	175	71	141	176	66
25 x 50	10/ 16	727 104 107	105	175	71	143	174	66
32 x 63	10/ 16	727 104 108	120	190	81	160	187	81
40 x 75	10/ 16	727 104 109	145	225	101	188	220	97
50 x 90	10/ 10	727 104 110	160	250	110	206	242	113
63 x 110	10/ 10	727 104 111	195	290	132	245	278	136
75 x 125	10/ 10	727 104 112	210	315	142	263.5	299	151
90 x 140	10/ 10	727 104 113	250	360	178	310.5	340	196
110 x 160	10/ 10	727 104 114	260	375	178	330	349	196

Elbow 45° HD PP-H / PE100

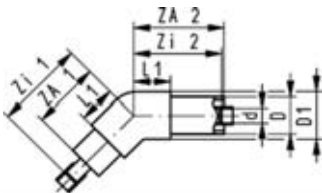

d x D	PN	Code	ZA 1	ZA 2	L1	Zi 1	Zi 2	D1
20 x 50	10/ 16	727 154 106	105	175	56	141	176	66
25 x 50	10/ 16	727 154 107	105	175	56	143	174	66
32 x 63	10/ 16	727 154 108	120	190	63	160	187	81
40 x 75	10/ 16	727 154 109	145	225	79	188	220	97
50 x 90	10/ 10	727 154 110	160	250	85	206	242	113
63 x 110	10/ 10	727 154 111	195	290	103	245	278	136
75 x 125	10/ 10	727 154 112	210	315	107	263.5	299	151
90 x 140	10/ 10	727 154 113	250	360	134	310.5	340	196
110 x 160	10/ 10	727 154 114	260	375	134	330	349	196

T90° equal HD PP-H / PE100

T 45° on request

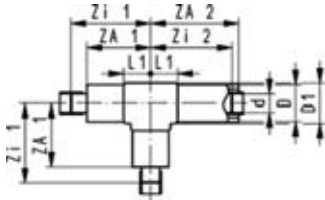

d x D	PN	Code	ZA 1	ZA 2	L1	Zi 1	Zi 2	D1
20 x 50	10/ 16	727 204 106	105	175	42.5	141	176	54
25 x 50	10/ 16	727 204 107	105	175	42.5	143	174	54
32 x 63	10/ 16	727 204 108	120	190	50	160	187	67
40 x 75	10/ 16	727 204 109	145	225	61	188	220	79
50 x 90	10/ 10	727 204 110	160	250	70.5	206	242	101
63 x 110	10/ 10	727 204 111	195	290	80	245	278	119
75 x 125	10/ 10	727 204 112	210	315	90.5	263.5	299	134
90 x 140	10/ 10	727 204 113	250	360	108	310.5	340	170
110 x 160	10/ 10	727 204 114	260	375	108	330	349	170

Termination Fitting HD PP-H / PE100

Sealing in body EPDM

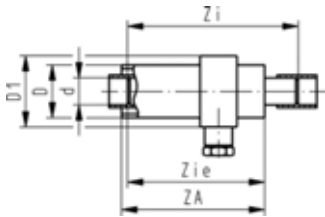

d x D	PN	Code	ZA	Zi	Zie	D1
20 x 50	10/ 10	727 964 106	175	212	176	70
25 x 50	10/ 10	727 964 107	175	212	174	70
32 x 63	10/ 10	727 964 108	185	222	182	80
40 x 75	10/ 10	727 964 109	205	243	200	90
50 x 90	10/ 10	727 964 110	250	288	242	110
63 x 110	10/ 10	727 964 111	270	308	258	130
75 x 125	10/ 10	727 964 112	290	327.5	274	140
90 x 140	10/ 10	727 964 113	310	350.5	290	160
110 x 160	10/ 10	727 964 114	330	374	304	170

Connection of inner pipe by butt fusion (HS)

Elbow 90° HS PP-H / PE100 S5/ SDR11

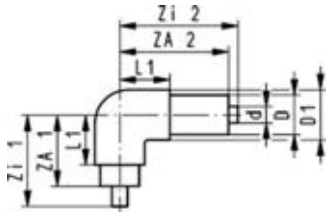

d x D	FM	Code	ZA 1	ZA 2	L1	Zi 1	Zi 2	D1	
20 x 50	IR	727 104 206	105	175	71	120	190	66	
25 x 50	IR	727 104 207	105	175	71	120	190	66	
32 x 63	IR	727 104 208	120	190	81	135	205	81	
40 x 75	-	727 104 209	145	225	101	160	240	97	
50 x 90	-	727 104 210	160	250	110	175	265	113	
63 x 110	IR	727 104 211	195	290	132	210	305	136	
75 x 125	IR	727 104 212	210	315	142	225	330	151	
90 x 140	IR	727 104 213	250	360	178	265	375	196	
110 x 160	IR	727 104 214	260	375	178	275	390	196	
125 x 180		727 104 215							
140 x 200		727 104 216							
160 x 225		727 104 217							
200 x 280		727 104 219							
225 x 315		727 104 220							

Elbow 45° HS PP-H / PE100 S5/ SDR11

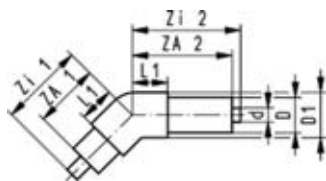

d x D	FM	Code	ZA 1	ZA 2	L1	Zi 1	Zi 2	D1	
20 x 50	IR	727 154 206	105	175	56	120	190	66	
25 x 50	IR	727 154 207	105	175	56	120	190	66	
32 x 63	IR	727 154 208	120	190	63	135	205	81	
40 x 75	-	727 154 209	145	225	79	160	240	97	
50 x 90	-	727 154 210	160	250	85	175	265	113	
63 x 110	IR	727 154 211	195	290	103	210	305	136	
75 x 125	IR	727 154 212	210	315	107	225	330	151	
90 x 140	IR	727 154 213	250	360	134	265	375	196	
110 x 160	IR	727 154 214	260	375	134	275	390	196	
125 x 180		727 154 215							
140 x 200		727 154 216							
160 x 225		727 154 217							
200 x 280		727 154 219							
225 x 315		727 154 220							

T90° equal HS PP-H / PE100 S5/ SDR11

T45° on request

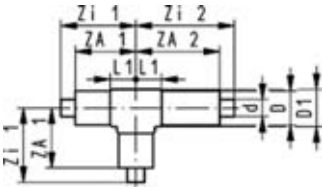

d x D	FM	Code	ZA 1	ZA 2	L1	Zi 1	Zi 2	D1
20 x 50	IR	727 204 206	105	175	42.5	120	190	54
25 x 50	IR	727 204 207	105	175	42.5	120	190	54
32 x 63	IR	727 204 208	120	190	50	135	205	67
40 x 75	-	727 204 209	145	225	61	160	240	79
50 x 90	-	727 204 210	160	250	70.5	175	265	101
63 x 110	IR	727 204 211	195	290	80	210	305	119
75 x 125	IR	727 204 212	210	315	90.5	225	330	134
90 x 140	IR	727 204 213	250	360	108	265	375	170
110 x 160	IR	727 204 214	260	375	108	275	390	170
125 x 180		727 204 215						
140 x 200		727 204 216						
160 x 225		727 204 217						
200 x 280		727 204 219						
225 x 315		727 204 220						

Termination Fitting HS PP-H / PE100 S5/ SDR11

Sealing in body EPDM

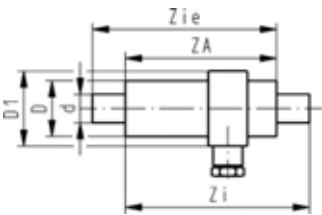

d x D	FM	Code	ZA	Zi	Zie	D1
20 x 50	IR	727 964 206	157	205	190	70
25 x 50	IR	727 964 207	175	205	190	70
32 x 63	IR	727 964 208	185	25	200	80
40 x 75	-	727 964 209	205	235	220	90
50 x 90	-	727 964 210	250	280	265	110
63 x 110	IR	727 964 211	270	300	285	130
75 x 125	IR	727 964 212	290	320	305	140
90 x 140	IR	727 964 213	310	340	325	160
110 x 160	IR	727 964 214	330	360	345	170
125 x 180		727 964 215				
140 x 200		727 964 216				
160 x 225		727 964 217				
200 x 280		727 964 219				
225 x 315		727 964 220				

Double Containment Ball Valve

Inner pipe PP-H Socket / Outer pipe PE

Ball Valve Type 346, PP-H Connections for socket fusion

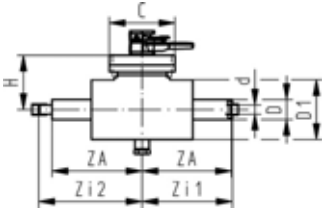

Model:

- Manual operated
- Manual override with ratchet setting
- Retrofit with an electric or pneumatic actuator unit
- Radial installation and removal possible
- Protection housing PE PN6

d x D	PN	EPDM Code	FPM Code	ZA	Zi 1	Zi 2	Ø C	D1	H
20 x 50	10/6	700 238 854	700 238 860	235	236	271	151	170	152
25 x 50	10/6	700 238 855	700 238 861	235	234	273	151	170	152
32 x 63	10/6	700 238 856	700 238 862	240	237	280	151	170	152
40 x 75	10/6	700 238 857	700 238 863	290	285	333	196	215	201
50 x 90	10/6	700 238 858	700 238 864	305	297	351	196	215	201
63 x 110	10/6	700 238 859	700 238 865	335	323	385	225	235	221

Inner pipe PP-H SDR11 / Outer pipe PE

Ball Valve Type 346 PP-H S5/ SDR11 Connections for butt fusion

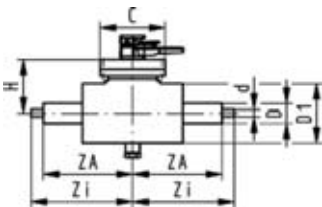

Model:

- Manual operated
- Manual override with ratchet setting
- Retrofit with an electric or pneumatic actuator unit
- Radial installation and removal possible
- Protection housing PE PN6

d x D	FM	PN	EPDM Code	FPM Code	ZA	Zi	Ø C	D1	H
20 x 50	IR	10/6	700 238 908	700 238 914	235	250	151	151	152
25 x 50	IR	10/6	700 238 909	700 238 915	235	250	151	151	152
32 x 63	IR	10/6	700 238 910	700 238 916	240	255	151	151	152
40 x 75	-	10/6	700 238 911	700 238 917	290	305	196	196	201
50 x 90	-	10/6	700 238 912	700 238 918	305	320	196	196	201
63 x 110	IR	10/6	700 238 913	700 238 919	335	350	225	225	221

Inner pipe and connection elements PP-H

Pipes S3,2/SDR7,4 (PN16)

67 48 10

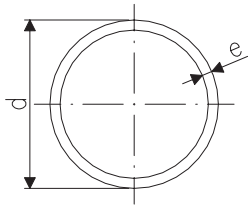

Model:

- Material: PP-H, Polypropylene DIN 8078
- Colour: RAL 7032 - gravel grey
- Dimension: DIN 8077
- Pipe lengths: 5m, with plain ends

for socket fusion without stiffeners, not suitable for butt fusion

d	PN	Code	e
20	16	167 481 028	2,8
25	16	167 481 029	3,5

67 48 07

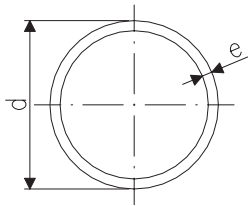

Medium pipes PP-H S5/SDR11

Model:

- Material: PP-H, Polypropylene DIN 8078
- Colour: RAL 7032 - gravel grey
- Dimension: DIN 8077
- Pipe lengths: 5m, with plain ends

* In these two sizes, stiffeners Code No. 727 900 006 (20 x 1,9) and 727 900 007 (25 x 2,3) must be used with socket fusion joints

d	Code	e
*20	167 480 711	1,9
*25	167 480 712	2,3
32	167 480 713	2,9
40	167 480 714	3,7
50	167 480 715	4,6
63	167 480 716	5,8
75	167 480 717	6,8
90	167 480 718	8,2
110	167 480 719	10,0
125	167 480 720	11,4
160	167 480 722	14,6
180	167 480 723	16,4
225	167 480 725	20,5

Sockets equal

27 91 01

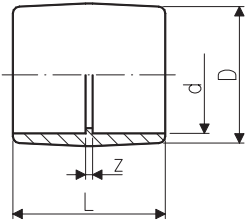

d	PN	Code	D	L	z
20	10	727 910 106	30,5	35	7
25	10	727 910 107	36	39	7
32	10	727 910 108	43,5	43	7
40	10	727 910 109	53,5	48	8
50	10	727 910 110	66	54	8
63	10	727 910 111	82	62	8
75	10	727 910 112	93	69,5	7,5
90	10	727 910 113	112	80,5	10,5
110	10	727 910 114	134	96	14

27 90 00

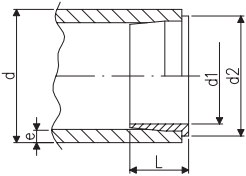

Stiffeners, PP-H

Used as support during d20 and d25 socket fusion jointing to prevent the pipe from collapsing during the heating and jointing process.

d x e	Code	L	d1	d2
20x1,9	727 900 006	9,5	14	17,5
25x2,3	727 900 007	11	18	22,5

Double Containment Fitting PE / PE100

Connection of inner pipe by socket fusion (HD)

Elbow 90° HD PE80 / PE100

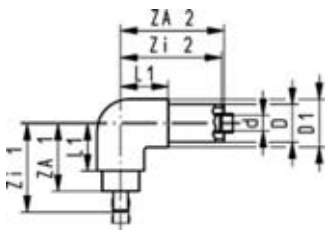

d x D	PN	Code	ZA 1	ZA 2	L1	Zi 1	Zi 2	D1
20 x 50	10/ 16	733 104 106	105	175	71	141	176	66
25 x 50	10/ 16	733 104 107	105	175	71	143	174	66
32 x 63	10/ 16	733 104 108	120	190	81	160	187	81
40 x 75	10/ 16	733 104 109	145	225	101	188	220	97
50 x 90	10/ 10	733 104 110	160	250	110	206	242	113
63 x 110	10/ 10	733 104 111	195	290	132	245	278	136
75 x 125	10/ 10	733 104 112	210	315	142	263.5	299	151
90 x 140	10/ 10	733 104 113	250	360	178	310.5	340	196
110 x 160	10/ 10	733 104 114	260	375	178	330	349	196

Elbow 45° HD PE80 / PE100

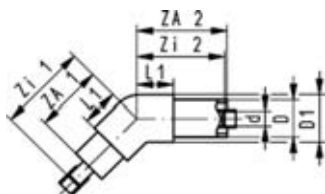

d x D	PN	Code	ZA 1	ZA 2	L1	Zi 1	Zi 2	D1
20 x 50	10/ 16	733 154 106	105	175	56	141	176	66
25 x 50	10/ 16	733 154 107	105	175	56	143	174	66
32 x 63	10/ 16	733 154 108	120	190	63	160	187	81
40 x 75	10/ 16	733 154 109	145	225	79	188	220	97
50 x 90	10/ 10	733 154 110	160	250	85	206	242	113
63 x 110	10/ 10	733 154 111	195	290	103	245	278	136
75 x 125	10/ 10	733 154 112	210	315	107	263.5	299	151
90 x 140	10/ 10	733 154 113	250	360	134	310.5	340	196
110 x 160	10/ 10	733 154 114	260	375	134	330	349	196

T90° equal HD PE80 / PE100

T 45° on request

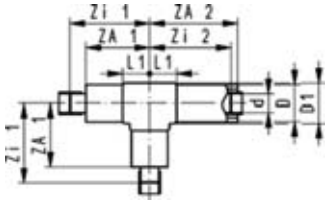

d x D	PN	Code	ZA 1	ZA 2	L1	Zi 1	Zi 2	D1
20 x 50	10/ 16	733 204 106	105	175	42.5	141	176	54
25 x 50	10/ 16	733 204 107	105	175	42.5	143	174	54
32 x 63	10/ 16	733 204 108	120	190	50	160	187	67
40 x 75	10/ 16	733 204 109	145	225	61	188	220	79
50 x 90	10/ 10	733 204 110	160	250	70.5	206	242	101
63 x 110	10/ 10	733 204 111	195	290	80	245	278	119
75 x 125	10/ 10	733 204 112	210	315	90.5	263.5	299	134
90 x 140	10/ 10	733 204 113	250	360	108	310.5	340	170
110 x 160	10/ 10	733 204 114	260	375	108	330	349	170

Termination Fitting HD PE80 / PE100

Sealing in body EPDM

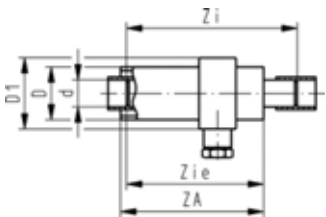

d x D	PN	Code	ZA	Zi	Zie	D1
20 x 50	10/ 10	733 964 106	175	212	176	70
25 x 50	10/ 10	733 964 107	175	212	174	70
32 x 63	10/ 10	733 964 108	185	222	182	80
40 x 75	10/ 10	733 964 109	205	243	200	90
50 x 90	10/ 10	733 964 110	250	288	242	110
63 x 110	10/ 10	733 964 111	270	308	258	130
75 x 125	10/ 10	733 964 112	290	327.5	274	140
90 x 140	10/ 10	733 964 113	310	350.5	290	160
110 x 160	10/ 10	733 964 114	330	374	304	170

Connection of inner pipe by butt fusion (HS)

Elbow 90° HS PE100 / PE100 S5/ SDR11

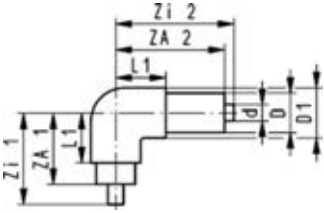

d x D	FM	Code	ZA 1	ZA 2	L1	Zi 1	Zi 2	D1	
20 x 50	IR	753 104 206	105	175	71	120	190	66	
25 x 50	IR	753 104 207	105	175	71	120	190	66	
32 x 63	IR	753 104 208	120	190	81	135	205	81	
40 x 75	-	753 104 209	145	225	101	160	240	97	
50 x 90	-	753 104 210	160	250	110	175	265	113	
63 x 110	IR	753 104 211	195	290	132	210	305	136	
75 x 125	IR	753 104 212	210	315	142	225	330	151	
90 x 140	IR	753 104 213	250	360	178	265	375	196	
110 x 160	IR	753 104 214	260	375	178	275	390	196	
125 x 180		753 104 215							
140 x 200		753 104 216							
160 x 225		753 104 217							
200 x 280		753 104 219							
225 x 315		753 104 220							

Elbow 45° HS PE100 / PE100 S5/ SDR11

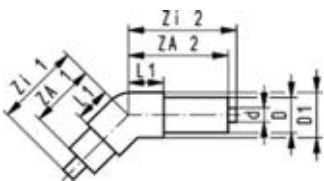

d x D	FM	Code	ZA 1	ZA 2	L1	Zi 1	Zi 2	D1	
20 x 50	IR	753 154 206	105	175	56	120	190	66	
25 x 50	IR	753 154 207	105	175	56	120	190	66	
32 x 63	IR	753 154 208	120	190	63	135	205	81	
40 x 75	-	753 154 209	145	225	79	160	240	97	
50 x 90	-	753 154 210	160	250	85	175	265	113	
63 x 110	IR	753 154 211	195	290	103	210	305	136	
75 x 125	IR	753 154 212	210	315	107	225	330	151	
90 x 140	IR	753 154 213	250	360	134	265	375	196	
110 x 160	IR	753 154 214	260	375	134	275	390	196	
125 x 180		753 154 215							
140 x 200		753 154 216							
160 x 225		753 154 217							
200 x 280		753 154 219							
225 x 315		753 154 220							

T90° equal HS PE100 / PE100 S5/ SDR11

T45° on request

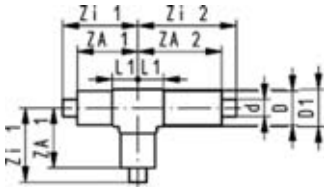

d x D	FM	Code	ZA 1	ZA 2	L1	Zi 1	Zi 2	D1
20 x 50	IR	753 204 206	105	175	42.5	120	190	54
25 x 50	IR	753 204 207	105	175	42.5	120	190	54
32 x 63	IR	753 204 208	120	190	50	135	205	67
40 x 75	-	753 204 209	145	225	61	160	240	79
50 x 90	-	753 204 210	160	250	70.5	175	265	101
63 x 110	IR	753 204 211	195	290	80	210	305	119
75 x 125	IR	753 204 212	210	315	90.5	225	330	134
90 x 140	IR	753 204 213	250	360	108	265	375	170
110 x 160	IR	753 204 214	260	375	108	275	390	170
125 x 180		753 204 215						
140 x 200		753 204 216						
160 x 225		753 204 217						
200 x 280		753 204 219						
225 x 315		753 204 220						

Termination Fitting HS PE100 / PE100 S5/ SDR11

Sealing in body EPDM

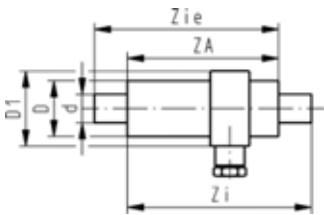

d x D	FM	Code	ZA	Zi	Zie	D1
20 x 50	IR	753 964 206	157	205	190	70
25 x 50	IR	753 964 207	175	205	190	70
32 x 63	IR	753 964 208	185	25	200	80
40 x 75	-	753 964 209	205	235	220	90
50 x 90	-	753 964 210	250	280	265	110
63 x 110	IR	753 964 211	270	300	285	130
75 x 125	IR	753 964 212	290	320	305	140
90 x 140	IR	753 964 213	310	340	325	160
110 x 160	IR	753 964 214	330	360	345	170
125 x 180		753 964 215				
140 x 200		753 964 216				
160 x 225		753 964 217				
200 x 280		753 964 219				
225 x 315		753 964 220				

Double Containment Ball Valve

Inner pipe PE Socket / Outer pipe PE

Ball Valve Type 346, PVC-U Connections for socket fusion

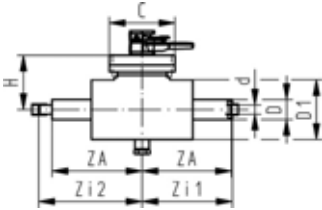

Model:

- Manual operated
- Manual override with ratchet setting
- Retrofit with an electric or pneumatic actuator unit
- Radial installation and removal possible
- Protection housing PE PN6

d x D	PN	EPDM Code	FPM Code	ZA	Zi 1	Zi 2	Ø C	D1	H
20 x 50	10/6	700 238 866	700 238 872	235	236	271	151	170	152
25 x 50	10/6	700 238 867	700 238 873	235	234	273	151	170	152
32 x 63	10/6	700 238 868	700 238 874	240	237	280	151	170	152
40 x 75	10/6	700 238 869	700 238 875	290	285	333	196	215	201
50 x 90	10/6	700 238 870	700 238 876	305	297	351	196	215	201
63 x 110	10/6	700 238 871	700 238 877	335	323	385	225	235	221

Ball Valve Type 346, PP-H Connections for socket fusion

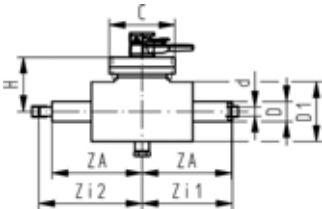

Model:

- Manual operated
- Manual override with ratchet setting
- Retrofit with an electric or pneumatic actuator unit
- Radial installation and removal possible
- Protection housing PE PN6

d x D	PN	EPDM Code	FPM Code	ZA	Zi 1	Zi 2	Ø C	D1	H
20 x 50	10/6	700 238 878	700 238 884	235	236	271	151	170	152
25 x 50	10/6	700 238 879	700 238 885	235	234	273	151	170	152
32 x 63	10/6	700 238 880	700 238 886	240	237	280	151	170	152
40 x 75	10/6	700 238 881	700 238 887	290	285	333	196	215	201
50 x 90	10/6	700 238 882	700 238 888	305	297	351	196	215	201
63 x 110	10/6	700 238 883	700 238 889	335	323	385	225	235	221

Inner pipe PE SDR11 / Outer pipe PE

Ball Valve Type 346 PVC-U S5 SDR11

Connections for butt fusion

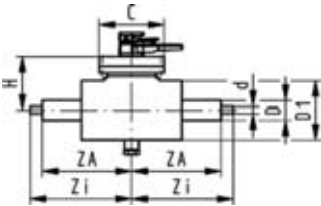

Model:

- Manual operated
- Manual override with ratchet setting
- Retrofit with an electric or pneumatic actuator unit
- Radial installation and removal possible
- Protection housing PE PN6

d x D	PN	EPDM Code	FPM Code	ZA	Zi	Ø C	D1	H	
20 x 50	16/6	700 238 920	700 238 926	235	236	151	170	152	
25 x 50	16/6	700 238 921	700 238 927	235	234	151	170	152	
32 x 63	16/6	700 238 922	700 238 928	240	237	151	170	152	
40 x 75	16/6	700 238 923	700 238 929	290	285	196	215	201	
50 x 90	16/6	700 238 924	700 238 930	305	297	196	215	201	
63 x 110	16/6	700 238 925	700 238 931	335	323	225	235	221	

Ball Valve Type 346 PP-H S5 SDR11

Connections for butt fusion

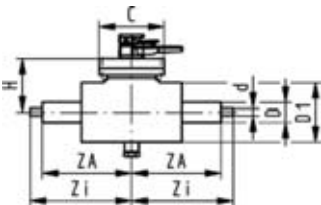

Model:

- Manual operated
- Manual override with ratchet setting
- Retrofit with an electric or pneumatic actuator unit
- Radial installation and removal possible
- Protection housing PE PN6

d x D	PN	EPDM Code	FPM Code	ZA	Zi	Ø C	D1	H	
20 x 50	10/6	700 238 932	700 238 938	235	236	151	170	152	
25 x 50	10/6	700 238 933	700 238 939	235	234	151	170	152	
32 x 63	10/6	700 238 934	700 238 940	240	237	151	170	152	
40 x 75	10/6	700 238 935	700 238 941	290	285	196	215	201	
50 x 90	10/6	700 238 936	700 238 942	305	297	196	215	201	
63 x 110	10/6	700 238 937	700 238 943	335	323	225	235	221	

Inner pipe and connection elements PE

Medium pipes PE100 S3,2/ SDR7,4

93 01 72

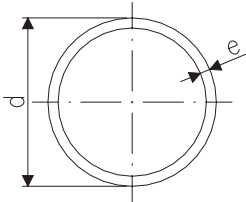

Model:

- Material: PP-H, Polypropylene DIN 8078
- Colour: RAL 9011 - graphite black
- Dimension: DIN 8077
- Pipe lengths: 5m, with plain ends

For socket fusion without stiffeners
Not suitable for butt fusion

d	Code	e
20	193 017 206	2,8
25	193 017 207	3,5

93 01 71

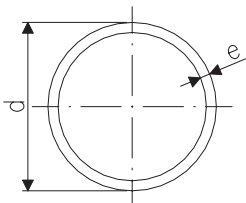

Medium pipes PE100 S5/SDR11

Model:

- Material: PP-H, Polypropylene DIN 8078
- Colour: RAL 7032 - gravel grey
- Dimension: DIN 8077
- Pipe lengths: 5m, with plain ends

* In these two sizes, stiffeners Code No. 727 900 006 (20 x 1,9) and 727 900 007 (25 x 2,3) must be used with socket fusion joints.

d	Code	e
* 20	193 017 156	1,9
* 25	193 017 157	2,3
32	193 017 158	2,9
40	193 017 159	3,7
50	193 017 160	4,6
63	193 017 161	5,8
75	193 017 162	6,8
90	193 017 163	8,2
110	193 017 164	10,0
125	193 017 165	11,4
140	193 017 166	12,7
160	193 017 167	14,6
180	193 017 168	16,4
200	193 017 169	18,2
225	193 017 170	20,5

Sockets equal, PE80

33 91 01

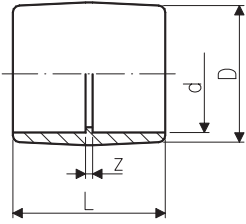

d	PN	Code	D	L	z
20	10	733 910 106	30,5	35	7
25	10	733 910 107	36	39	7
32	10	733 910 108	43,5	43	7
40	10	733 910 109	53,5	48	8
50	10	733 910 110	66	54	8
63	10	733 910 111	82	62	8
75	10	733 910 112	93	69,5	7,5
90	10	733 910 113	112	80,5	10,5
110	10	733 910 114	134	96	14

33 90 00

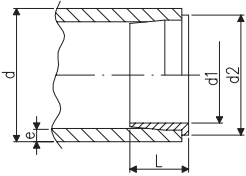

Stiffeners PE

Used as support during d20 and d25 socket fusion jointing to prevent the pipe from collapsing during the heating process.

d x e	Code	d1	d2	L
20x1,9	733 900 006	14	17,5	9,5
25x2,3	733 900 007	18	22,5	11

Double Containment Fitting PVDF / PE100

Connection of inner pipe by socket fusion (HD)

Elbow 90° HD PVDF / PE100

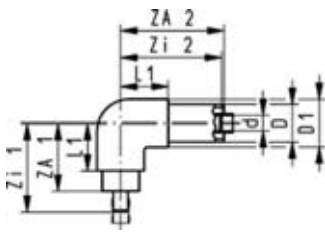

d x D	PN	Code	ZA 1	ZA 2	L1	Zi 1	Zi 2	D1
20 x 50	16/ 16	735 104 106	105	175	71	141	176	66
25 x 50	16/ 16	735 104 107	105	175	71	143	174	66
32 x 63	16/ 16	735 104 108	120	190	81	160	187	81
40 x 75	16/ 16	735 104 109	145	225	101	188	220	97
50 x 90	16/ 10	735 104 110	160	250	110	206	242	113
63 x 110	16/ 10	735 104 111	195	290	132	245	278	136
75 x 125	16/ 10	735 104 112	210	315	142	263.5	299	151
90 x 140	16/ 10	735 104 113	250	360	178	310.5	340	196
110 x 160	16/ 10	735 104 114	260	375	178	330	349	196

Elbow 45° HD PVDF / PE100

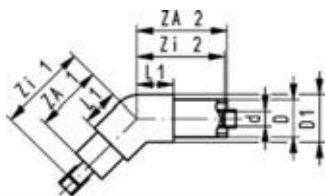

d x D	PN	Code	ZA 1	ZA 2	L1	Zi 1	Zi 2	D1
20 x 50	16/ 16	735 154 106	105	175	56	141	176	66
25 x 50	16/ 16	735 154 107	105	175	56	143	174	66
32 x 63	16/ 16	735 154 108	120	190	63	160	187	81
40 x 75	16/ 16	735 154 109	145	225	79	188	220	97
50 x 90	16/ 10	735 154 110	160	250	85	206	242	113
63 x 110	16/ 10	735 154 111	195	290	103	245	278	136
75 x 125	16/ 10	735 154 112	210	315	107	263.5	299	151
90 x 140	16/ 10	735 154 113	250	360	134	310.5	340	196
110 x 160	16/ 10	735 154 114	260	375	134	330	349	196

T90° equal HD PVDF / PE100

T45° on request

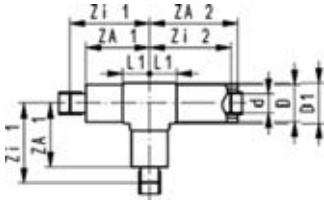

d x D	PN	Code	ZA 1	ZA 2	L1	Zi 1	Zi 2	D1
20 x 50	10/ 16	735 204 106	105	175	42.5	141	176	54
25 x 50	16/ 16	735 204 107	105	175	42.5	143	174	54
32 x 63	16/ 16	735 204 108	120	190	50	160	187	67
40 x 75	16/ 16	735 204 109	145	225	61	188	220	79
50 x 90	16/ 10	735 204 110	160	250	70.5	206	242	101
63 x 110	16/ 10	735 204 111	195	290	80	245	278	119
75 x 125	16/ 10	735 204 112	210	315	90.5	263.5	299	134
90 x 140	16/ 10	735 204 113	250	360	108	310.5	340	170
110 x 160	16/ 10	735 204 114	260	375	108	330	349	170

Termination Fitting HD PVDF / PE100

Sealing in body EPDM

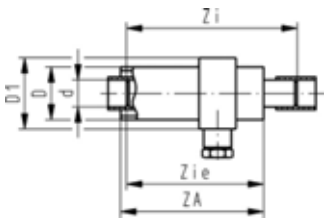

d x D	PN	Code	ZA	Zi	Zie	D1
20 x 50	16/ 10	735 964 106	175	212	176	70
25 x 50	16/ 10	735 964 107	175	212	174	70
32 x 63	16/ 10	735 964 108	185	222	182	80
40 x 75	16/ 10	735 964 109	205	243	200	90
50 x 90	16/ 10	735 964 110	250	288	242	110
63 x 110	16/ 10	735 964 111	270	308	258	130
75 x 125	16/ 10	735 964 112	290	327.5	274	140
90 x 140	16/ 10	735 964 113	310	350.5	290	160
110 x 160	16/ 10	735 964 114	330	374	304	170

Connection of inner pipe by butt fusion (HS)

Elbow 90° HS PVDF / PE100

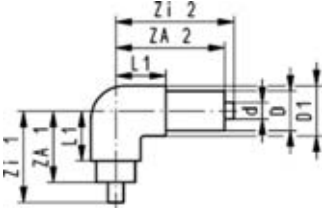

d x D	PN	FM	Code	ZA 1	ZA 2	L1	Zi 1	Zi 2	D1
20 x 50	16/ 16	IR	735 104 206	105	175	71	120	190	66
25 x 50	16/ 16	IR	735 104 207	105	175	71	120	190	66
32 x 63	16/ 16	IR	735 104 208	120	190	81	135	205	81
40 x 75	16/ 16	-	735 104 209	145	225	101	160	240	97
50 x 90	16/ 10	-	735 104 210	160	250	110	175	265	113
63 x 110	16/ 10	IR	735 104 211	195	290	132	210	305	136
75 x 125	16/ 10	IR	735 104 212	210	315	142	225	330	151
90 x 140	16/ 10	IR	735 104 213	250	360	178	265	375	196
110 x 160	16/ 10	IR	735 104 214	260	375	178	275	390	196
125 x 180	10/ 10		735 104 265						
140 x 200	10/ 10		735 104 266						
160 x 225	10/ 10		735 104 267						
200 x 280	10/ 10		735 104 269						
225 x 315	10/ 10		735 104 270						

Elbow 45° HS PVDF / PE100

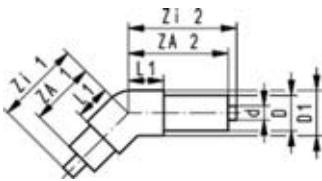

d x D	PN	FM	Code	ZA 1	ZA 2	L1	Zi 1	Zi 2	D1
20 x 50	16/ 16	IR	735 154 206	105	175	56	120	190	66
25 x 50	16/ 16	IR	735 154 207	105	175	56	120	190	66
32 x 63	16/ 16	IR	735 154 208	120	190	63	135	205	81
40 x 75	16/ 16	-	735 154 209	145	225	79	160	240	97
50 x 90	16/ 10	-	735 154 210	160	250	85	175	265	113
63 x 110	16/ 10	IR	735 154 211	195	290	103	210	305	136
75 x 125	16/ 10	IR	735 154 212	210	315	107	225	330	151
90 x 140	16/ 10	IR	735 154 213	250	360	134	265	375	196
110 x 160	16/ 10	IR	735 154 214	260	375	134	275	390	196
125 x 180	10/ 10		735 154 265						
140 x 200	10/ 10		735 154 266						
160 x 225	10/ 10		735 154 267						
200 x 280	10/ 10		735 154 269						
225 x 315	10/ 10		735 154 270						

T90° equal HS PVDF / PE100

T45° on request

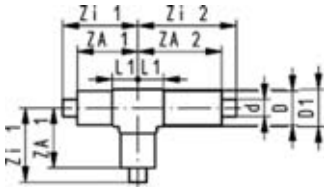

d x D	PN	FM	Code	ZA 1	ZA 2	L1	Zi 1	Zi 2	D1
20 x 50	16/ 16	IR	735 204 206	105	175	42.5	120	190	54
25 x 50	16/ 16	IR	735 204 207	105	175	42.5	120	190	54
32 x 63	16/ 16	IR	735 204 208	120	190	50	135	205	67
40 x 75	16/ 16	-	735 204 209	145	225	61	160	240	79
50 x 90	16/ 10	-	735 204 210	160	250	70.5	175	265	101
63 x 110	16/ 10	IR	735 204 211	195	290	80	210	305	119
75 x 125	16/ 10	IR	735 204 212	210	315	90.5	225	330	134
90 x 140	16/ 10	IR	735 204 213	250	360	108	265	375	170
110 x 160	10/ 10	IR	735 204 214	260	375	108	275	390	170
125 x 180	10/ 10	-	735 204 265						
140 x 200	10/ 10	-	735 204 266						
160 x 225	10/ 10	-	735 204 267						
200 x 280	10/ 10	-	735 204 269						
225 x 315	10/ 10	-	735 204 270						

Termination Fitting HS PVDF / PE100

Sealing in body EPDM

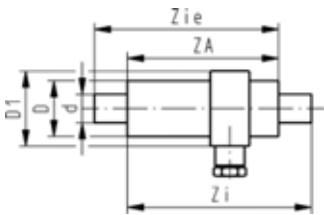

d x D	PN	FM	Code	ZA	Zi	Zie	D1
20 x 50	16/ 10	IR	735 964 206	157	205	190	70
25 x 50	16/ 10	IR	735 964 207	175	205	190	70
32 x 63	16/ 10	IR	735 964 208	185	25	200	80
40 x 75	16/ 10	-	735 964 209	205	235	220	90
50 x 90	16/ 10	-	735 964 210	250	280	265	110
63 x 110	16/ 10	IR	735 964 211	270	300	285	130
75 x 125	16/ 10	IR	735 964 212	290	320	305	140
90 x 140	16/ 10	IR	735 964 213	310	340	325	160
110 x 160	16/ 10	IR	735 964 214	330	360	345	170
125 x 180	10/ 10	-	735 964 265				
140 x 200	10/ 10	-	735 964 266				
160 x 225	10/ 10	-	735 964 267				
200 x 280	10/ 10	-	735 964 269				
225 x 315	10/ 10	-	735 964 270				

Double Containment Ball Valve

Inner pipe PVDF Socket / Outer pipe PE

Ball Valve Type 346, PVDF Connections for socket fusion

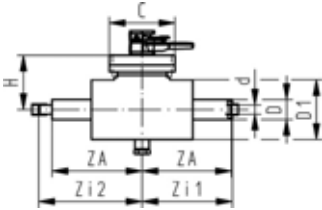

Model:

- Manual operated
- Manual override with ratchet setting
- Retrofit with an electric or pneumatic actuator unit
- Radial installation and removal possible
- Protection housing PE PN6

d x D	PN	FPM Code	ZA	Zi 1	Zi 2	Ø C	D1	H
20 x 50	16/6	700 238 890	235	236	271	151	170	152
25 x 50	16/6	700 238 891	235	234	273	151	170	152
32 x 63	16/6	700 238 892	240	237	280	151	170	152
40 x 75	16/6	700 238 893	290	285	333	196	215	201
50 x 90	16/6	700 238 894	305	297	351	196	215	201
63 x 110	16/6	700 238 895	335	323	385	225	235	221

Inner pipe PVDF PN16 / Outer pipe PE

Ball Valve Type 346 PVDF Connections for butt fusion

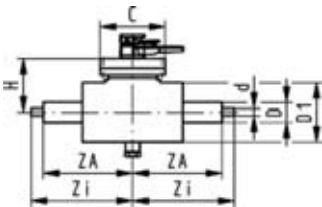

Model:

- Manual operated
- Manual override with ratchet setting
- Retrofit with an electric or pneumatic actuator unit
- Radial installation and removal possible
- Protection housing PE PN6

d x D	FM	PN	FPM Code	ZA	Zi	Ø C	D1	H
20 x 50	IR	16/6	700 238 944	235	250	151	151	152
25 x 50	IR	16/6	700 238 945	235	250	151	151	152
32 x 63	IR	16/6	700 238 946	240	255	151	151	152
40 x 75	-	16/6	700 238 947	290	305	196	196	201
50 x 90	-	16/6	700 238 948	305	320	196	196	201
63 x 110	IR	16/6	700 238 949	335	350	225	225	221

Inner pipe and connection elements PVDF

Medium pipes PVDF PN 16

75 48 02

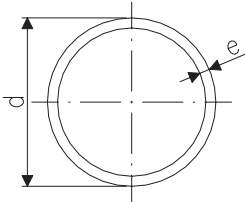

d	PN	Code	e	kg/m	m	
20	16	175 480 203	1,9	0,209	5	
25	16	175 480 204	1,9	0,278	5	
32	16	175 480 205	2,4	0,425	5	
40	16	175 480 206	2,4	0,550	5	
50	16	175 480 207	3,0	0,835	5	
63	16	175 480 208	3,0	1,080	5	
75	16	175 480 209	3,6	1,519	5	
90	16	175 480 210	4,3	2,232	5	
110	16	175 480 211	5,3	3,336	5	

75 48 06

Medium pipes PVDF PN 10

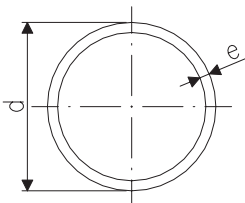

d	PN	Code	e	kg/m	m	
125	10	175 480 667	3,9	2,800	5	
140	10	175 480 673	4,3	3,710	5	
160	10	175 480 668	4,9	4,657	5	
200	10	175 480 669	6,2	6,916	5	
225	10	175 480 670	6,9	9,162	5	

Sockets equal

35 91 01

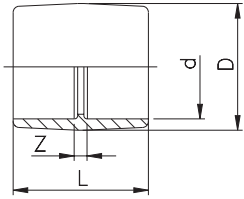

d	PN	Code	D	L	z
20	16	735 910 106	30,5	35	7
25	16	735 910 107	36	39	7
32	16	735 910 108	43,5	43	7
40	16	735 910 109	53,5	48	8
50	16	735 910 110	66	54	8
63	16	735 910 111	82	62	8
75	16	735 910 112	93	69,5	7,5
90	16	735 910 113	112	80,5	10,5
110	16	735 910 114	134,7	96	14

Tools and Machines

Welding tools



SG110

For fusion jointing of PP, PE, PB and PVDF pipes and fittings

Portable heating element - socket fusion machine for use in the workshop and on job sites.

Dimension d 20 110 mm

d	Performance	Code	
20-110	230 V/1200 W	790 310 001	
20-110 *	115 V/1200 W	790 310 003	

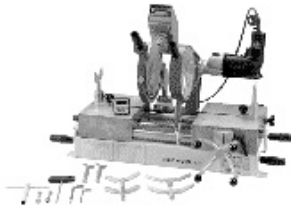

SG160

for fusion jointing PP, PE and PVDF pipes and fittings

Mobile, very compact and universal plastic fusion machine for use in the workshop and on job sites

d	Performance	Code	
16-160	230 V	790 103 031	
16-160*	115 V	790 103 033	



GF315

for butt fusion jointing of PP, PE and PVDF pipes and fittings

The industrial butt fusion machine for pressure piping systems. Extremely sturdy design use in the workshop and on job sites.

d	Performance	Code	
90-315	230 V	790 130 001	
90-315 *	115 V	790 130 002	

MSE 63/MSE 110 MSE Socket fusion tools

For fusion jointing of PP, PE and PVDF pipes and fittings
Size range d 16 - 110 mm



d	Type	Performance	Code
16-63	MSE 63	230 V/600 W T	790 105 081
16-63	MSE 63	230 V/600 W T	790 105 081
16-63	MSE 63	230 V/600 W E	790 105 082
16-63	MSE 63	115 V/600 W T	790 105 096
16-63	MSE 63	115 V/600 W E	790 105 097
16-110	MSE 110	230 V/1500 W T	790 105 083
16-110	MSE 110	230 V/1500 W E	790 105 084
16-110	MSE 110	115 V/1500 W T	790 105 126
16-110	MSE 110	115 V/1500 W E	790 105 127

MSA 400 Traceability Electrofusion Unit

Professional electrofusion unit for traceability of piping system components from raw material to completed electrofusion joint (to ISO 12176).



Typ	Code	Description
MSA 400	799 350 376	Standard, with barcode reader pen
MSA 400	799 350 451	Plus I, with barcode scanner (799 350 419)
MSA 400	799 350 452	Plus II, with barcode scanner (799 350 419) and transport case (799 350 399)
MSA 400	799 350 398	Special Edition, with barcode reader pen and 10 m primary cable
MSA 400	799 350 384	MSA 400 standard machine

IR-63 Plus® Fully-Equipped Machine

Fully-equipped fusion jointing machine for welding SYGEF® PVDF standard, SYGEF® PVDF HP and +GF+ PP in dimensions d 20-63 mm with integrated remote welding unit.



Supply:

1-phase AC (50/60 Hz) 230 V L/N/PE

d	Code
20-63	790 131 005



Half shell special AL for IR-63 Plus®

Die Halbschalen sind dimensionsabhängig. Sie spannen und fixieren die zu verschweisenden Rohrleitungskomponenten.

d	Code	Pieces	
20	700 238 100	1	
25	700 238 101	1	
32	700 238 102	1	
40	700 238 103	1	
50	700 238 104	1	



IR-225 Plus® Fully-Equipped Machine with HP Working Table (HP = High Purity)

Fully-equipped fusion jointing machine for fusion of dimensions d 63-225 mm of SYGEF® PVDF Standard, SYGEF® PVDF HP and **+GF+** PP. The working table is made of steel with a stainless steel table for use in clean room environment.

Supply:

1-phase AC (50/60 Hz) 230 V L/N/PE or 3-phase AC (50/60 Hz) 400 V/230 V L1/L2/L3/N/PE

d	Code	
63-225	790 133 009	



Half shell special AL for IR-225 Plus®

Die Halbschalen sind dimensionsabhängig. Sie spannen und fixieren die zu verschweisenden Rohrleitungskomponenten.

d	Code	Pieces	
63	700 238 105	1	
75	700 238 106	1	
90	700 238 107	1	
110	700 238 108	1	



Pipe Cutter

Type	d	Code	max. Pipe wall thickness	
KRA 63	10-63	790 109 001	7,2	
KRA 110	50-110	790 109 002	12,7	
KRA 160	110-160	790 109 003	19,0	



Manual pipe peeling and chamfering tools

for PP/PE/PVDF

d	Code
20	799 300 260
25	799 300 270
32	799 300 280
40	799 300 290
50	799 300 300
63	799 300 310
75	799 300 320
90	799 300 330
110	799 300 340



Rotary Peeler RS

This innovative Rotary Peeler RS is designed to use for universal peeling at the pipe end for electrofusion couplings, tees and elbows and as well as for electrofusion saddles. Suitable for peeling of pipes made out of PE80, PE100, PEX, PP.

Article	d	Code
RS 40	40	790 136 001
RS 50	50	790 136 002
RS 63	63	790 136 003
RS 75	75	790 136 004
RS 90	90	790 136 005
RS 110	110	790 136 006
RS 125	125	790 136 007
RS 140	140	790 136 008
RS 160	160	790 136 009
RS 180	180	790 136 010
RS 200	200	790 136 011
RS 225	225	790 136 012
RS 250	250	790 136 013
RS 280	280	790 136 014
RS 315	315	790 136 015

MSE 63/MSE 110 MSE Socket fusion tools

For fusion jointing of PP, PE and PVDF pipes and fittings
Size range d 16 - 110 mm

d	Type	Performance	Code
16-63	MSE 63	230 V/600 W T	790 105 081
16-63	MSE 63	230 V/600 W T	790 105 081
16-63	MSE 63	230 V/600 W E	790 105 082
16-63	MSE 63	115 V/600 W T	790 105 096
16-63	MSE 63	115 V/600 W E	790 105 097
16-110	MSE 110	230 V/1500 W T	790 105 083
16-110	MSE 110	230 V/1500 W E	790 105 084
16-110	MSE 110	115 V/1500 W T	790 105 126
16-110	MSE 110	115 V/1500 W E	790 105 127



Cementing tools

Tangit Solvent Cement for PVC-U



Special solvent cement, transparent. We recommend the use of "DYTEX" solvent cement for systems carrying strong oxidizing acids. Instructions for jointing see Design Fundamentals for PVC-U.

- 0.125 kg tube
- 0.250, 0.500 and 1.000 kg tin



	Code	kg	
	799 298 000	0,125	
	799 298 001	0,250	
	799 298 002	0,500	
	799 298 003	1,000	

TANGIT PVC-C Solvent Cement Solvent cement tin



	Code		
	799 298 027		

Dytex Special Solvent Cement

- 1.35 kg tin



	Code		
	799 298 012		

Cap for cement

- Cap for cement prevents the evaporation of the solvent whilst using the Tangit cement



	Code		
	799 298 028		

Round Brushes



d	Size	Code	
6-10	4 mm (for fittings 6 - 10 mm)	799 299 001	
12-32	8 mm (for fittings 12 - 32 mm)	799 299 002	



Flat Brushes

d	Size	Code	
40-63	25x3 mm (for fittings 40 - 63 mm)	799 299 003	
75-225	50x5 mm (for fittings 75 - 225 mm)	799 299 004	
250-400	75x6 mm (for fittings 250 - 400 mm)	799 299 005	



Pipe Cutter

Type	d	Code	max. Pipe wall thickness	
KRA 63	10-63	790 109 001	7,2	
KRA 110	50-110	790 109 002	12,7	
KRA 160	110-160	790 109 003	19,0	



Chamfering Tool

Size	d	Code	
1	16-75	799 495 145	
2	32-200	799 495 146	

Cleaner

Tangit Cleaner

- 1 litre tin



	Code	
	799 298 010	

Dytex Cleaner

- 1 litre tin



	Code	
	799 298 013	

KS Tangit Cleaner

- special cleaner for plastic welding joints of PP, PE, PVDF, PB
- 1 litre container



	Code	
	799 298 023	

Tangit KS Cleaning Tissues

- special cleaner for plastic welding joints of PP, PE, PVDF, PB
- clean room approved

Standard packing TT8 = 8 boxes with 100 tissues each



Description	Code	
	799 298 024	

General Condition of Supply of Georg Fischer Piping Systems Limited, Schaffhausen

1 General

- 1.1 These General Conditions shall apply to all Products supplied by George Fischer to the Purchaser.
They shall also apply to all future business even when no express reference is made to them.
- 1.2 Any deviating or supplementary conditions especially Purchaser's general conditions of purchase and verbal agreements shall only be applicable if accepted in writing by George Fischer.
- 1.3 The written form shall be deemed to be fulfilled by all forms of transmission, evidenced in the form of text, such as telex, e-mail, etc.

2 Tenders

Tenders shall only be binding if they contain a specifically stated period for a acceptance.

3 Scope of Delivery

- 3.1 George Fischer's product range is subject to change.
- 3.2 The confirmation of order shall govern the scope and execution of the contract.

4 Data and Documents

- 4.1 Technical documents such as drawings descriptions illustrations and data on dimensions performance and weight as well as the reference to standards are for information purposes only. They are not warranted characteristics and are subject to change.
- 4.2 All technical documents shall remain the exclusive property of George Fischer and may only be used for the agreed purposes or as George Fischer may consent.

5 Confidentiality, Protection of Personal Data

- 5.1 Each party shall keep in strict confidence all commercial or technical information relating to the business of the other party, of which it has gained knowledge in the course of its dealing with the other party. Such information shall neither be disclosed to third parties nor used for other purposes than those for which the information has been supplied.
- 5.2 In the context of the contractual relation with the Purchaser personal data may be processed. The Purchaser agrees to the disclosure of said data to third parties such as foreign subcontractors and suppliers etc.

6 Local Laws and Regulations, Export Controls

- 6.1 The Purchaser shall bring to the attention of George Fischer all local laws and regulations at the place of destination which bear connection with the execution of the contract and the adherence to relevant safety regulations and approval procedures.
- 6.2 In case of re-exports, Purchaser shall be responsible for compliance with pertinent export control regulations.

7 Price

- 7.1 Unless agreed otherwise, the prices shall be deemed quoted net ex works (according to Incoterms of the ICC, latest version) including standard packing. All supplementary costs such as the cost of carriage insurance export and import licences etc. shall be borne by the Purchaser. The Purchaser shall also bear the costs of all taxes fees duties etc. connected with the contract.
- 7.2 If the costs of packing, carriage, insurance, fees and other supplementary costs are included in the tender price or contract price or are referred to specifically in the tender or confirmation of order, George Fischer reserve the right to revise their prices accordingly should any change occur in the relevant tariffs.

8 Terms of Payment

- 8.1 The Purchaser shall make payment in the manner agreed by the parties to the George Fischer works conducting the account without any deductions such as discounts, costs, taxes or dues.
- 8.2 The Purchaser may only withhold or off-set payments due against counter claims which are either expressly acknowledged by George Fischer or finally awarded to the Purchaser. In particular, payment shall still be made when unessential items are still outstanding provided, however, that the Products already delivered are not rendered unusable as a result.

9 Retention of Title

- 9.1 The Products shall remain the property of George Fischer until the Purchaser shall have settled all claims, present and future, which George Fischer may have against him.
- 9.2 Should the Purchaser sell Products to which title is reserved, in the ordinary course of business, he shall hereby be deemed to have tacitly assigned to George Fischer the proceeds deriving from their sale together with all collateral rights, securities and reservations of title until all claims held by George Fischer shall have been settled. Until revoked by George Fischer, this assignment shall not preclude Purchaser's right to collect the assigned receivables.
- 9.3 To the extent the value of the Products to which title is reserved together with collateral securities should exceed George Fischer's claims against the Purchaser by more than 20%, George Fischer shall re-assign the above proceeds to Purchaser at his request.

10 Delivery

- 10.1 The term of delivery shall commence as soon as the contract has been entered into, all official formalities such as import and payment permits have been obtained and all essential technical points have been settled. The term of delivery shall be deemed duly observed when, upon its expiry, the Products are ready for despatch.
- 10.2 Delivery is subject to the following conditions, i.e. the term of delivery shall be reasonably extended:
 - a) if George Fischer are not supplied in time with the information necessary for the execution of the contract or if subsequent changes causing delays are made by the Purchaser.
 - b) if George Fischer are prevented from performing the contract by force majeure. Force majeure shall equally be deemed to be any unforeseeable event beyond George Fischer's control which renders George Fischer's performance commercially impractical or impossible, such as delayed or defective supplies from sub contractors labour disputes, governmental orders or regulations, shortages in materials or energy, serious disturbances in George Fischer's works, such as the total or partial destruction of plant and equipment or the breakdown of essential facilities, serious disruptions in transport facilities, e.g. impassable roads.
Should the effect of force majeure exceed a period of six months, either party may cancel the contract forthwith.
George Fischer shall not be liable for any damage or loss of any kind whatsoever resulting therefrom, any suspension or cancellation being without prejudice to George Fischer's right to re over all sums due in respect of consignments delivered and costs incurred to date.
 - c) if the Purchaser is in delay with the fulfilment of his obligations under the contract, in particular, if he does not adhere to the agreed conditions of payment or if he has failed to timely provide the agreed securities.
- 10.3 If for reasons attributable to George Fischer the agreed term of delivery or a reasonable extension thereof is exceeded, George Fischer shall not be deemed in default until the Purchaser has granted to George Fischer in writing a reasonable extension thereof of not less than one month which equally is not met.
The Purchaser shall then be entitled to the remedies provided at law, it being however understood that, subject to limitations of Art. 16, damage claims shall be limited to max. 10% of the price of the delayed delivery.
- 10.4 Part shipments shall be allowed and George Fischer shall be entitled to invoice for such deliveries.
- 10.5 If the Purchaser fails to take delivery within a reasonable time of Products notified as ready for despatch, George Fischer shall be entitled to store the Products at the Purchaser's expense and risk and to invoice them as delivered. If Purchaser fails to effect payment, George Fischer shall be entitled to dispose of the Products.

- 10.6 Should Purchaser cancel an order without justification and should George Fischer not insist on the performance of the contract, George Fischer shall be entitled to damages in the amount of 10% of the contract price, unless George Fischer can prove higher damages.

11 Packing

If the Products are provided with additional packing over and above the standard packing, such packing shall be invoiced separately and be non-returnable.

12 Passing of Risk

- 12.1 The risk in the Products shall pass to the Purchaser as soon as they have left George Fischer's works (EX WORKS, Incoterms ICC, latest version), even if delivery is made carriage-paid, under similar clauses or including installation or when carriage is organized and managed by George Fischer.
- 12.2 If delivery is delayed for reasons beyond George Fischer's control, the risk shall pass to the Purchaser when he is notified that the Products are ready for despatch.

13 Carriage and Insurance

- 13.1 Unless agreed otherwise, the Purchaser shall bear the cost of carriage.
- 13.2 The Purchaser shall be responsible for transport insurance against damage of whatever kind. Even when such insurance is arranged by George Fischer it shall be deemed taken out by the order of and for the account of the Purchaser and at his risk.
- 13.3 Special requests regarding carriage and insurance shall be communicated to George Fischer in due time. Otherwise carriage shall be arranged by George Fischer at their discretion, but without responsibility, by the quickest and cheapest method possible.
In case of carriage-paid delivery transport arrangements shall be made by George Fischer. If the Purchaser specifies particular requirements, any extra costs involved shall be borne by him.
- 13.4 In the event of damage or loss of the Products during carriage the Purchaser shall mark the delivery documents accordingly and immediately have the damage ascertained by the carrier. Not readily ascertainable damages sustained during carriage shall be notified to the carrier within six days after receipt of the Products.

14 Inspection and Acceptance

- 14.1 The Products will be subject to normal inspection by George Fischer during manufacture. Additional tests required by the Purchaser shall be agreed upon in writing and shall be charged to the Purchaser.
- 14.2 It shall be a condition of George Fischer's obligation under the warranties stated hereinafter that George Fischer be notified in writing by the Purchaser of any purported defect immediately upon discovery. Notice concerning weight, numbers or apparent defects is to be given latest within 30 days from receipt of the Products, notice of other defects latest within the agreed warranty period.
- 14.3 Purchaser shall not dispose of allegedly defective Products until all warranty and/or damage claims are finally settled. At its request, defective Products are to be placed at George Fischer's disposal.
- 14.4 At its request, George Fischer shall be given the opportunity to inspect the damage, prior to commencement of remedial work, either itself or by third party experts.

15 Warranty

- 15.1 At the written request of the Purchaser, George Fischer undertake to repair or replace at their discretion, as quickly as possible and free of charge all Products supplied which demonstrably suffer from faulty design, materials or workmanship or from faulty operating or installation instructions.
Replaced parts shall become property of George Fischer.
For Products which are manufactured to specifications, drawings or patterns supplied by the Purchaser, George Fischer's warranty shall be restricted to proper materials and workmanship.
- 15.2 The Purchaser shall be entitled to cancel the contract or to demand a reduction in the contract price if:
 - repair or replacement is impossible, or
 - George Fischer are unable or refuse to remedy the defect or replace the defective Products within a reasonable, or
 - George Fischer are unduly delaying such remedy or replacement.
- 15.3 For Products or essential components manufactured by a third party and supplied by George Fischer under this contract, George Fischer's warranty is limited to the warranty provided by said third party.
- 15.4 This warranty shall not apply to damage resulting from normal wear, improper storage and maintenance, failure to observe the operating instructions, overstraining or overloading, unsuitable operating media, unsuitable construction work or unsuitable building ground, improper repairs or alterations by the Purchaser or third parties, the use of non-genuine parts and other reasons beyond George Fischer's control.
- 15.5 No action or claim may be brought by the Purchaser on account of any alleged breach of warranty or any other obligation of George Fischer after the expiration of twelve (12) months from receipt of the Products by the end user or at the latest within eighteen (18) months of the Products being despatched by George Fischer.
- 15.6 In case of Products for use in domestic installations or in utilities
 - George Fischer will assume the costs of dismantling the defective Product and restoring the damaged object as well as, in case of negligence, all other direct damages caused by the defective Product (damage to property and injury to or death of persons) up to CHF 1'000'000 per occurrence.
 - the statute of limitations for warranty or damage claims - contrary to Section 15.5 - will be 5 years from the date of installation.

16 Limitation of Liability

All cases of breach of contract and the relevant consequences as well as all rights and claims on the part of the customer, irrespective on what ground they are based, are exhaustively covered by these general conditions of supply. In particular, any claims not expressly mentioned for damages, reduction of price, termination of or withdrawal from the contract are excluded. In no case whatsoever shall the customer be entitled to claim damages other than compensation for costs of remedying defects in the supplies. This in particular refers, but shall not be limited, to loss of production, loss of use, loss of orders, loss of profit and other direct or indirect or consequential damage. This exclusion of liability, however, does not apply to unlawful intent or gross negligence on the part of George Fischer and in case of strict liability under applicable product liability statutes, but does apply to unlawful intent or gross negligence of persons employed or appointed by the supplier to perform any of its obligations.

17 Severability

Should any term or clause of these General Conditions in whole or in part be found to be unenforceable or void, all other provisions shall remain in full force and effect and the unenforceable or void provision shall be replaced by a valid provision, which comes closest to the original intention of the unenforceable or invalid provision.

18 Place of Performance and Jurisdiction

- 18.1 Place of performance for the Products shall be the George Fischer works from which the Products are despatched.
- 18.2 Any civil action based upon any alleged breach of this contract shall be filed and prosecuted exclusively in the courts of Schaffhausen, Switzerland.
George Fischer however reserves the right to file actions in any court having jurisdiction over controversies arising out of or in connection with the present contract.
- 18.3 The contract shall be governed by Swiss law without regard to conflict of law provisions that would require the application of another law.

CONTAIN-IT Plus – For our environment's sake



The technical data are not binding.
They are not warranted characteristics and are
subject to change. Please consult our General
Conditions of Supply.

Australia

George Fischer Pty Ltd
Kingsgrove NSW 2008
Phone +61(0)2/95 54 39 77
sales@georgefischer.com.au
www.georgefischer.com.au

Austria

Georg Fischer
Rohrleitungssysteme GmbH
3130 Herzogenburg
Phone +43(0)2782/856 43-0
office@georgefischer.at
www.georgefischer.at

Belgium/Luxembourg

Georg Fischer NV/SA
1070 Bruxelles/Brüssel
Phone +32(0)2/556 40 20
info.be@be.piping.georgefischer.com
www.georgefischer.be

Brazil

George Fischer Ltda
04795-100 São Paulo
Phone +55(0)11/5687 1311

China

Georg Fischer Piping Systems Ltd Shanghai
Pudong, Shanghai 201319
Phone +86(0)21/58 13 33 33
info@cn.piping.georgefischer.com
www.cn.piping.georgefischer.com

Denmark/Iceland

Georg Fischer A/S
2630 Taastrup
Phone +45 (0)70 22 19 75
info@dk.piping.georgefischer.com
www.georgefischer.dk

France

Georg Fischer S.A.S.
93208 Saint-Denis Cedex 1
Phone +33(0)1/492 21 34 1
info@georgefischer.fr
www.georgefischer.fr

Germany

Georg Fischer GmbH
73095 Albershausen
Phone +49(0)7161/302-0
info@georgefischer.de
www.rls.georgefischer.de

Georg Fischer DEKA GmbH
35232 Dautphetal-Mornshausen
Phone +49(0)6468/915-0
info@dekapipe.de
www.dekapipe.de

Greece

Georg Fischer S.p.A.
10434 Athens
Phone +30(0)1/882 04 91
office@piping-georgefischer.gr

India

Georg Fischer Piping Systems Ltd
400 093 Mumbai
Phone +91(0)22/820 2362
branchoffice@georgefischer.net

Italy

Georg Fischer S.p.A.
20063 Cernusco S/N (MI)
Phone +3902/921 861
office@piping.georgefischer.it
www.georgefischer.it

Japan

Georg Fischer Ltd
556-0011 Osaka,
Phone +81(0)6/6635 2691
info@georgefischer.jp
www.georgefischer.jp

Malaysia

Georg Fischer (M) Sdn. Bhd.
47500 Subang Jaya
Phone +60 (0)3-8024 7879
conne.kong@georgefischer.com.my

Netherlands

Georg Fischer N.V.
8161 PA Epe
Phone +31(0)578/678 222
info.vgnl@nl.piping.georgefischer.com
www.georgefischer.nl

Norway

Georg Fischer AS
1351 Rud
Phone +47(0)67 18 29 00
info@no.piping.georgefischer.com
www.georgefischer.no

Poland

Georg Fischer Sp. z o.o.
02-226 Warszawa
Phone +48(0)22/313 10 50
www.georgefischer.pl

Romania

Georg Fischer
Rohrleitungssysteme AG
70000 Bucharest - Sector 1
Phone +40(0)1/222 91 36
office@georgefischer.ro

Singapore

Georg Fischer Pte Ltd
417 845 Singapore
Phone +65(0)67 47 06 11
info@georgefischer.com.sg
www.georgefischer.com.sg

Spain/Portugal

Georg Fischer S.A.
28009 Madrid
Phone +34(0)91/781 98 90
info@georgefischer.es
www.georgefischer.es

Sweden/Finland

Georg Fischer AB
12523 Älvsjö-Stockholm
Phone +46(0)8/506 77 500
info@georgefischer.se
www.georgefischer.se

Switzerland

Georg Fischer Rohrleitungssysteme (Schweiz) AG
8201 Schaffhausen
Phone +41(0)52 631 30 26
info@rohrleitungssysteme.georgefischer.ch
www.piping.georgefischer.ch

United Kingdom/Ireland

Georg Fischer Sales Limited
Coventry, CV2 2ST
Phone +44(0)2476 535 535
info@georgefischer.co.uk
www.georgefischer.co.uk

USA/Canada/Latin America/Caribbean

George Fischer Inc.
Tustin, CA 92780-7258
Phone +1(714) 731 88 00, Toll Free 800/854 40 90
info@us.piping.georgefischer.com
www.us.piping.georgefischer.com

Export

Georg Fischer Rohrleitungssysteme (Schweiz) AG
8201 Schaffhausen
Phone +41(0)52 631 11 11
export@piping.georgefischer.com
www.piping.georgefischer.com