

SX (400V)

High performance Vector Control

- IP54 full range.
- Compact design & Robustness
- Built-in Filter according to C3 Class
- Built-in Fuses (From 200 kW)
- Safety according EN13849-1 and EN62061 standards
- Load curve control
- HCB technology (Half controlling Bridge)
- Logic programmability
- Pre-maintenance alarms
- Options flexibility (I/O's, Fieldbus, PTC/PT100, Multiple Pump control, Encoder, Crane control)
- Communications options (Modbus, Dnet, Profibus)
- 24 VDC control board supply
- Liquid cooling drive version
- 12-pulse rectifier option.
- Flexible cable connections & User Friendly wiring connection
- CE, UL, RoHS, DNV

Ratings

- 400 V Class three-phase 0.75 to 800 kW



Frequency inverters

System configuration

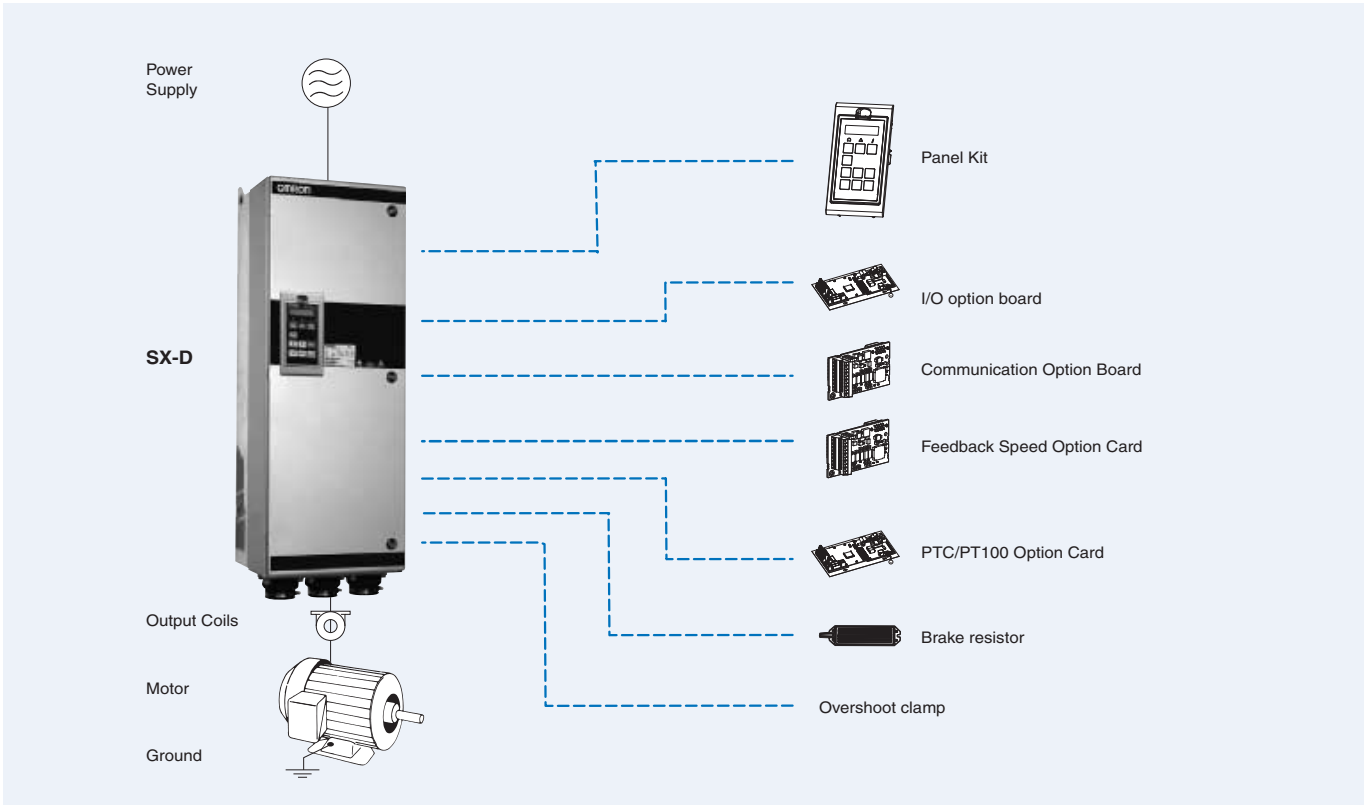

Specifications

Type designation

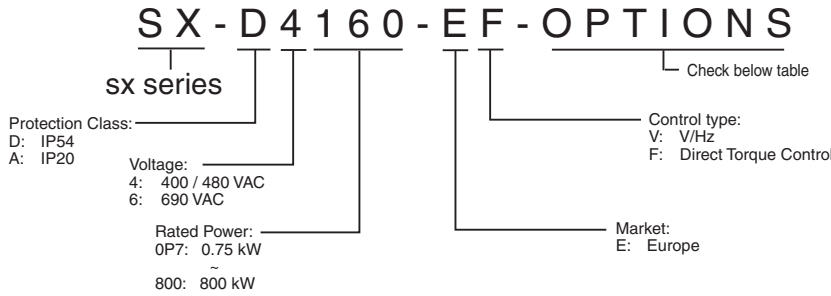

Options available

Options	Letter ("?" means no character)	Options	Letter ("?" means no character)
Control panel	"?" = Standard control panel (Std.PPU) "A" = Blank control panel (Blank PPU)	Option board position 3	"?" = No option "I" = Encoder "J" = PTC/PT100 "K" = Extended I/O"
Built-in EMC filter	"?" = Standard EMC inside (Category C3) "B" = IT-Net (filter disconnected from ground)	Option board position 4	"?" = No option "L" = DeviceNet "M" = Profibus-DP "N" = RS232/485 "O" = EtherNet Modbus TCP
Built-in brake chopper	"?" = No brake chopper or DC-connection included "C" = Brake chopper & DC-connection included "D" = Only DC-connection included	Liquid Cooling	"?" = No Liquid Cooling "P" = Liquid Cooling
Standby power supply	"?" = Not included "E" = Standby power supply included	Standard	"?" = IEC "Q" = UL
Safe stop	"?" = Not included "F" = Safe stop included	Marine	"?" = No marine option "R" = Marine option included
Coated boards	"?" = No coating "G" = Coated boards	Cabinet input options	"?" = No cabinet input options "S" = Main switch included "T" = Main contactor included "U" = Main switch + contactor included
Option board position 1	"?" = No option "H" = Crane I/O "I" = Encoder "J" = PTC/PT100 "K" = Extended I/O"	Cabinet output options	"?" = No cabinet output options included "V" = dV/dt filter included "W" = dV/dt filter + Overshoot clamp included "X" = Sinusfilter included
Option board position 2	"?" = No option "I" = Encoder "J" = PTC/PT100 "K" = Extended I/O"	additional options	"Z1" = Common mode output filter "Z2" = Cable gland kit "Z3" = Motor PTC connection Only models from 0.37 to 37KW

400 V class

Three-phase: SX-□4□□□-E□		OP7	1P5	2P2	3P0	4P0	5P5	7P5	011	015	018	022	030	037	045	055	
Motor kW ¹	For HD setting	0.55	1.1	1.5	2.2	3	4	5.5	7.5	11	15	18.5	22	30	37	45	
	For ND setting	0.75	1.5	2.2	3	4	5.5	7.5	11	15	18.5	22	30	37	45	55	
Output characteristics	Max output current (A) □-EF	3.8	6.0	9.0	11.3	14.3	19.5	27.0	39.0	46.0	55.0	69.0	92.0	111	108	131	
	Max output current (A) □-EV	3.0	4.8	7.2	9.0	11.4	15.6	21.6	31.0	37.0	44.0	55.0	73.0	89.0	108	131	
	Rated output current (A) at HD	2.0	3.2	4.8	6.0	7.6	10.4	14.4	21.0	25.0	29.6	37.0	49.0	59.0	72.0	87.0	
	Rated output current (A) at ND	2.5	4.0	6.0	7.5	9.5	13.0	18.0	26.0	31.0	37.0	46.0	61.0	74.0	90.0	109	
	Output voltage	0 to Mains supply voltage															
Max. output frequency	400 Hz																
Power supply	Rated input voltage and frequency	3-phase 230..480 V 50/60 Hz															
	Allowable voltage fluctuation	+10%..-15% (-10% at 230V)															
	Allowable frequency fluctuation	45 to 65 Hz															

1. Based on a standard 4-pole motor for maximum applicable motor output

400 V class

Three-phase: SX-□4□□□-E□		075	090	110	132	160	200	220	250	315	355	400	450	500	630	800	
Motor kW	For HD setting	55	75	90	110	132	160	200	220	250	315	355	400	450	500	630	
	For ND setting	75	90	110	132	160	200	220	250	315	355	400	450	500	630	800	
Output characteristics	Max output current (A) □-EF	175	210	252	300	360	450	516	600	720	780	900	1032	1200	1440	1800	
	Max output current (A) □-EV	175	210	252	300	360	450	516	600	720	780	900	1032	1200	1440	1800	
	Rated output current (A) at HD	117	140	168	200	240	300	344	400	480	520	600	688	800	960	1200	
	Rated output current (A) at ND	146	175	210	250	300	375	430	500	600	650	750	860	1000	1200	1500	
	Output voltage	0 to Mains supply voltage															
Max. output frequency	400 Hz																
Power supply	Rated input voltage and frequency	3-phase 230..480 V 50/60 Hz															
	Allowable voltage fluctuation	+10%..-15% (-10% at 230V)															
	Allowable frequency fluctuation	45 to 65 Hz															

Specifications

Common specifications

Model number SX-	Specifications	
Control functions	Control methods	V/f control for "V" type V/f control, Vector control with or without feedback for the "F" type
	Output frequency range	0.0..400 Hz
	Frequency tolerance	Analogue set value: 1% + 1.5 LSB fsd
	Resolution of frequency set value	Digital set value: 0.1 Hz Analogue set value: 0.03 Hz / 60 Hz (11 bit + sign)
	Resolution of output frequency	0.1 Hz
	Frequency set value	-10..+10 V (20 kΩ), 0..20 mA (250 Ω), frequency setting value (selectable)
	Starting Torque	150% for Heavy duty, 120% for Normal duty
	Torque static accuracy	<3% in Vector control with feedback <3% in vector control without feedback if speed between 10 and 100%, <10% at 0 Hz
	Torque response	1 ms for 0 - 90% speed 5 ms for 90 - 100% speed (Close and open loop)
	Speed Control Accuracy	V/f control 1% Vector control without feedback 0.1% Vector control with feedback 0.01%
	Speed Response	0.4% without encoder feedback 0.2% with encoder feedback
	Torque Limit	From Analog input
	Accel/Decel Time	0.0 to 3600.0 s
Functionality	Braking torque	5 - 10% (100% with external braking resistor)
	Main Control Functions	PID, sleep function, brake control, torque control (Direct torque control model), Pump/Fan control, Logic functions, virtual connections, overvoltage control, undervoltage override, autoreset, two motor support, Lim Switch, External trip, Preset Speeds, MotPot Up Down, Pump Feedback, Timer, Mot PreMag, Jog, Ext Mot Temp, Loc/Rem, AnIn select, Brk Ackn.
Protection functions	Motor protection	Motor overheat protection based on output current or PTC by option board
	Momentary overcurrent Protection	Drive stops when output current exceeds 200% of peak current
	Overload Protection	Drive stops after 1 min at 150% of rated output current (Heavy Duty Rating) Drive stops after 1 min at 120% of rated output current (Normal Duty Rating) (1min every 10min)
	Overvoltage Protection	Line Overvoltage: 760 VDC during more than 10s for 400 V class; Fast Overvoltage: 850 VDC for 400 V class
	Undervoltage Protection	400 VDC for 400 V class (Adjustable by input power supply parameter)
	Momentary power loss Ride-Thru	Low voltage override function
	Heatsink Overheat Protection	Protected by thermister
	Braking Resistance Overheat Protection	Hardware short circuit protection
	Stall prevention	Current limit function
	Power charge indication	Power LED remains lit until capacitors are charged
Ambient conditions	Ambient Temperature	0°C..+40°C, up to 45°C with derating
	Ambient humidity	90% RH or less (without condensation)
	Storage temperature	-20°C..+60°C (short-term temperature during transportation)
	Altitude	Up to 1000 meters (output derating of 1% per 100 m above 1000 m, max. 2000 m)
	Vibration / Shock	According to IEC 600068-2-6, Sinusoidal vibrations: 10<f<57 Hz, 0.075 mm, 57<f<150 Hz, 1g
	Contamination, according to IEC 60721-3-3	No electrically conductive dust allowed. Cooling air must be clean and free from corrosive materials. Chemical gases, class 3C2. Solid particles, class 3S2
Protection Design	IP54 enclosure according to the EN 60529	

Dimensions

Standard dimensions IP54

SX-D40P7 to D47P5

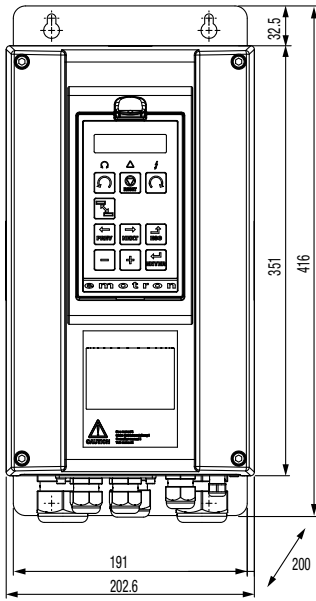

SX-D4011 to D4022

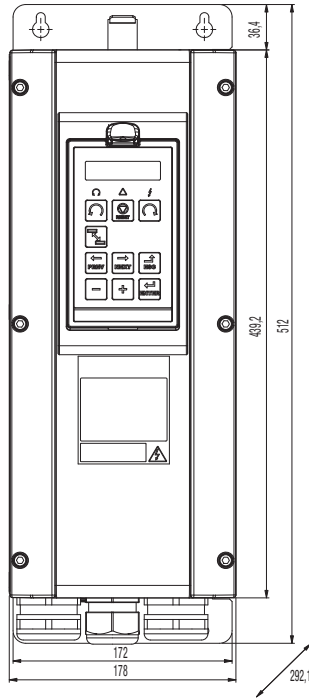

SX-D4030 to D4037

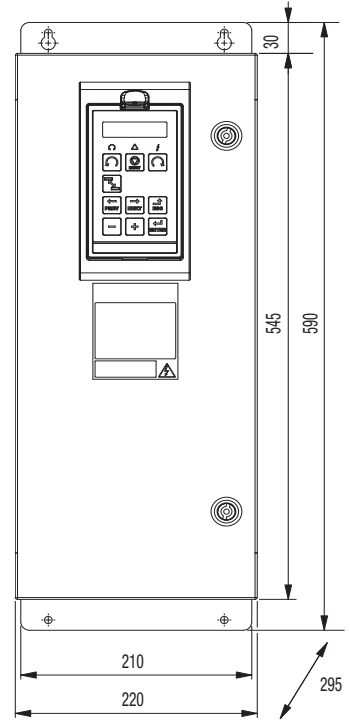

SX-D4045 to D4090

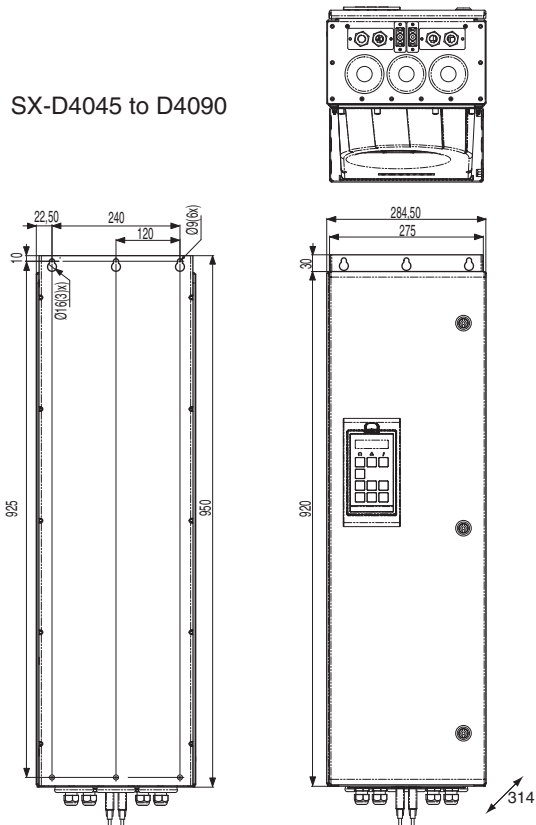

SX-D4110 to D4132

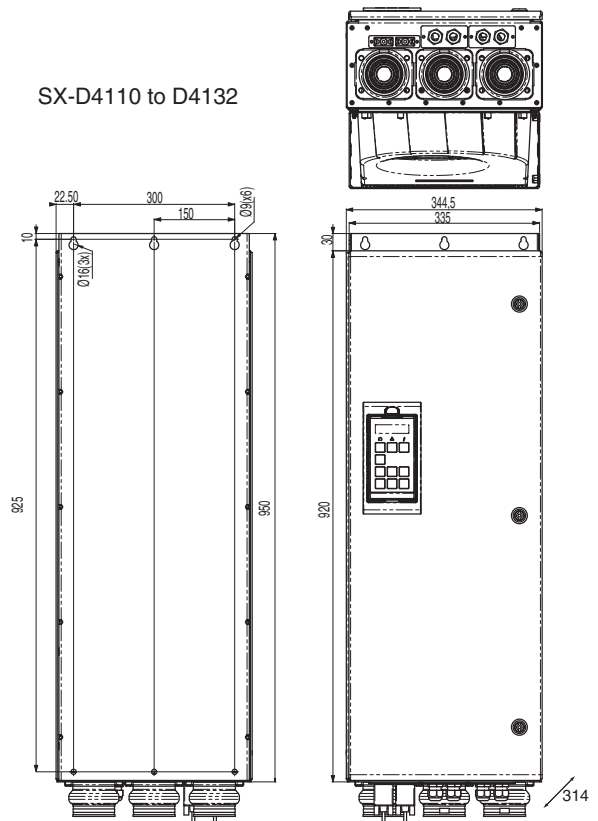

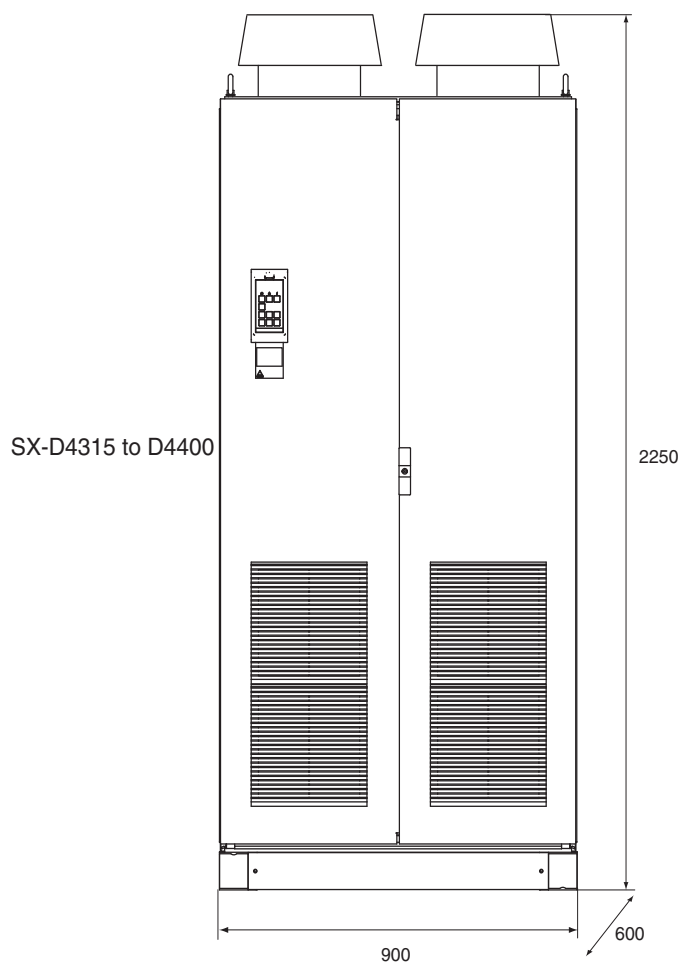
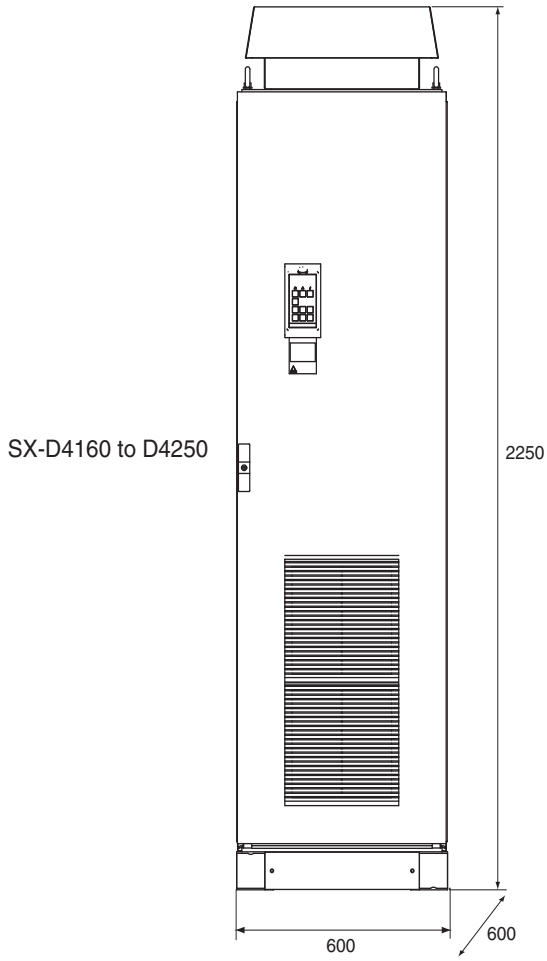

SX-D4450 to D4500

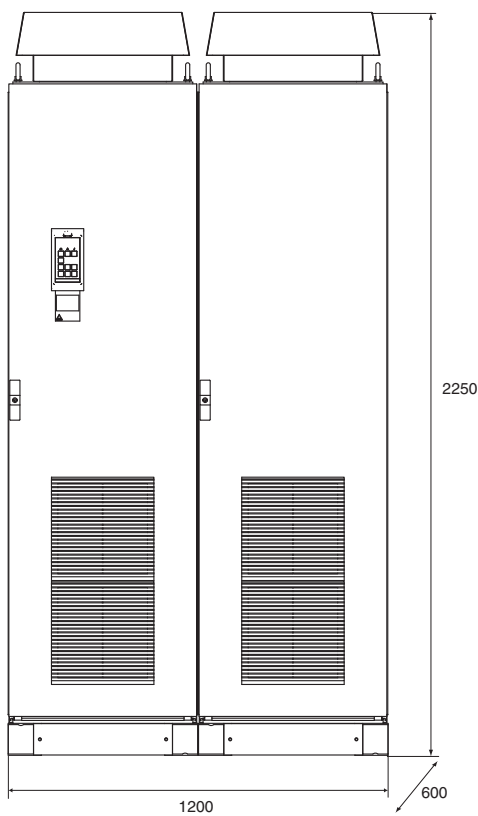

SX-D4630 to D4800

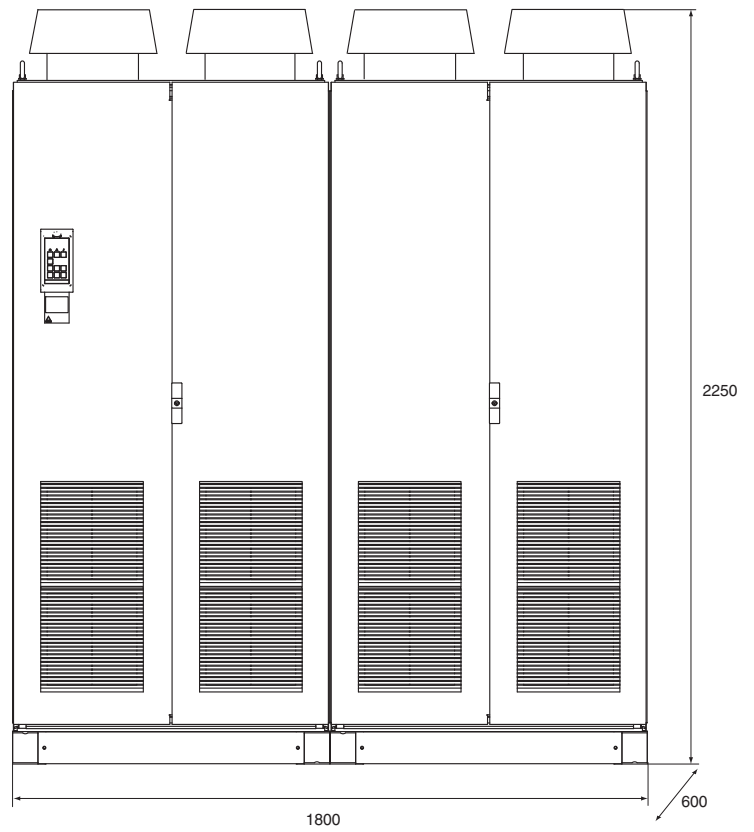

Standard dimensions IP20

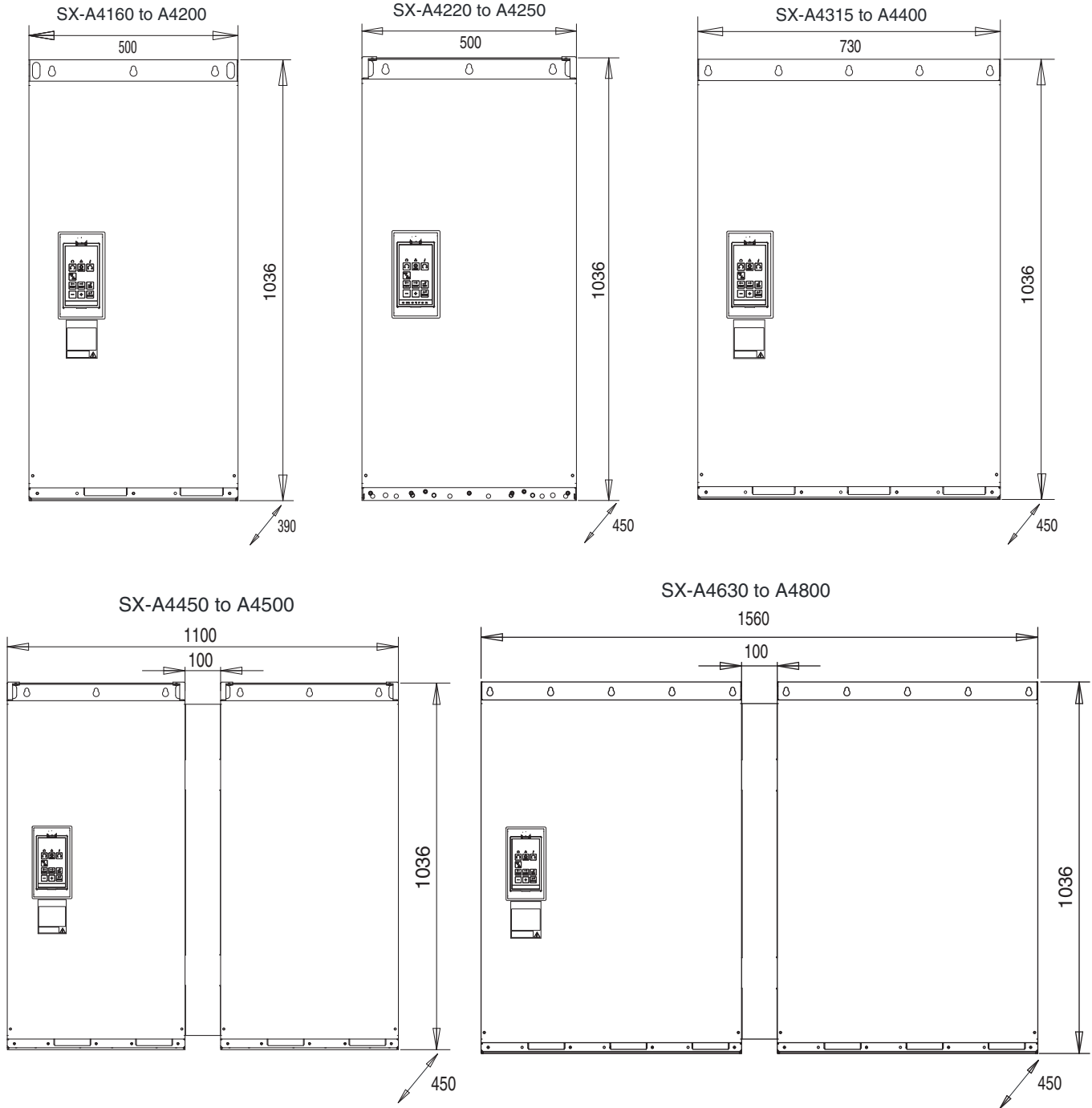

Weight and Air flow

Model SX-	Weight (Kg)		Air flow (m ³ /hour)
	SX-D (IP54)	SX-A (IP20)	
0P7 to 7P5	12.5	-	75
011 to 015	24	-	120
018 to 022	24	-	170
030 to 037	32	-	175
045 to 055	56	-	510
075 to 090	60	-	510
110 to 132	74	-	800
160 to 200	350	140	1020
220 to 250	380	170	1600
315 to 400	506	248	2400
450 to 500	697	340	3200
630 to 800	987	496	4800

LCD operator



Output coils

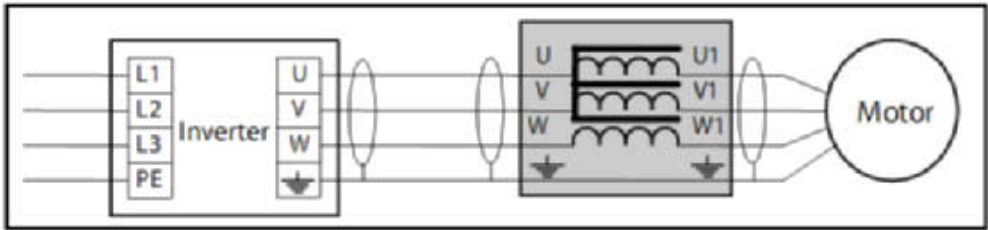
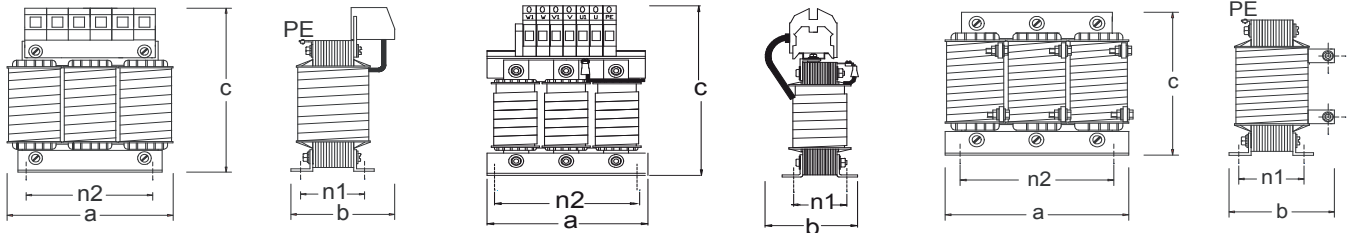

Figure 1

Figure 2

Figure 3



Type	Fig	a	b	c	n2	n1	Fix	Weight	Connection
473160 00	1	78	60	95	50	31	M4	0.6 kg	2.5 mm ²
473161 00									
473162 00									
473163 00									
473164 00									
473165 00									
473166 00	2	155	105	205	130	57	M5	4.0 kg	35 mm ²
473167 00									
473168 00									
473169 00	3	190	120	235	170	66	M6	8.4 kg	35 mm ²
473170 00									
473171 00									
473172 00									

Specifications

Model	Rated current	Inductance	Rated voltage	Max carrier	Max output frequency	Max temp	Protection Class
473160 00	2.8A	1.5 mH	800V	10 kHz	200Hz	40°C	IP00
473161 00	4.4A	1.0 mH					
473162 00	6.6A	0.65 mH					
473163 00	11.0A	0.4 mH					
473164 00	14.3A	0.3 mH					
473165 00	18.2A	0.25 mH					
473166 00	26.4A	0.17 mH5		6 kHz	100Hz	40°C	IP00
473167 00	32A	0.15 mH					
473168 00	65A	0.1 mH					
473169 00	90A	0.1 mH					
473170 00	146A	0.05 mH					
473171 00	175A	0.05 mH					
473172 00	275A	0.032 mH		1.5 kHz	100Hz	40°C	IP00

Installation

Standard connections

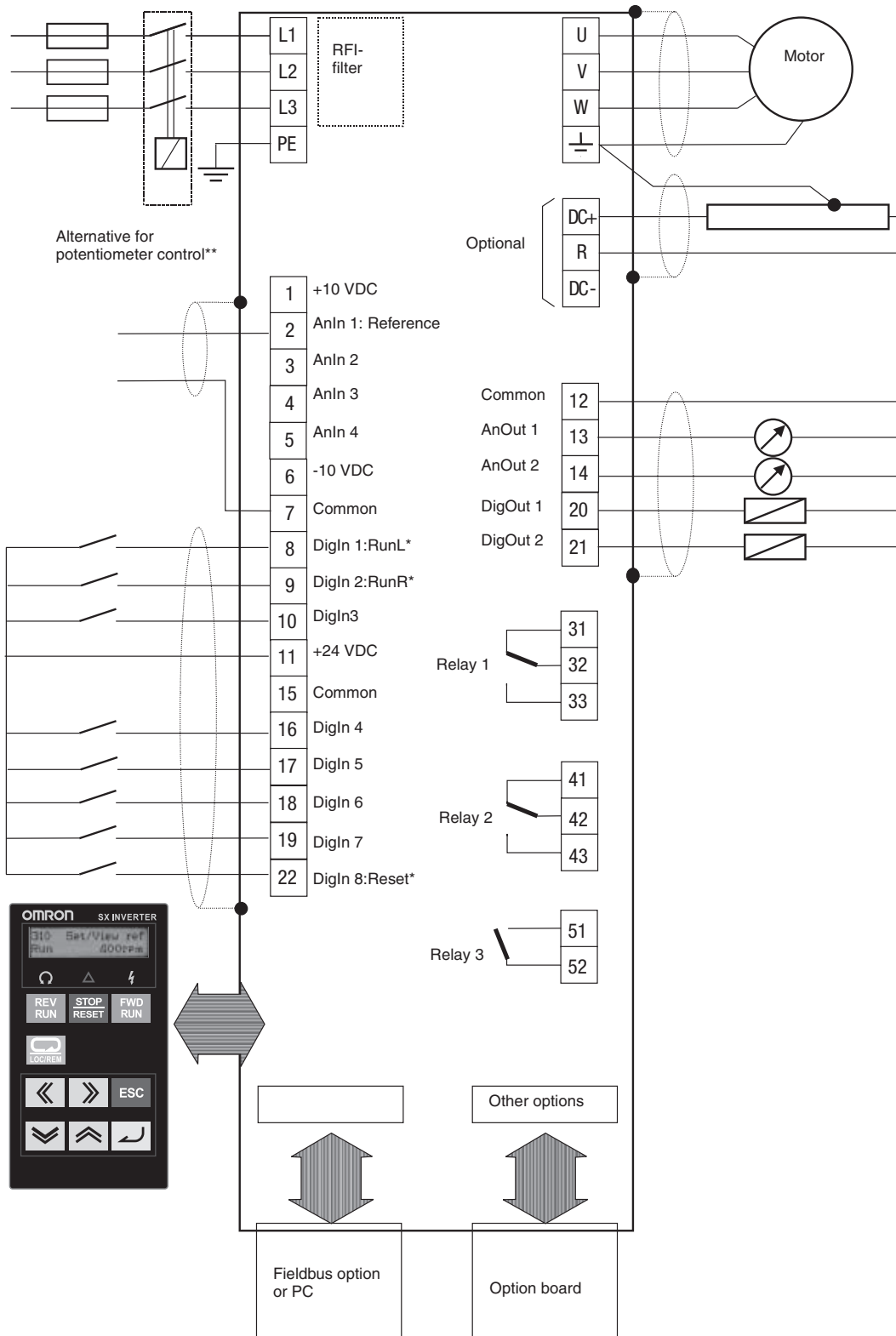

NG_06-F27

Main circuit

Terminal	Name	Function (signal level)
L1, L2, L3	Main circuit power supply input	Used to connect line power to the drive.
U, V, W	Inverter output	Used to connect the motor
DC-, DC+, R	DC link connections, Brake resistor	The brake resistor must be connected terminals DC+ and R (Terminals are only fitted if the Brake Chopper Option is built-in)
PE	Safety earth	Protected earth
	Grounding	Motor earth

Control Circuit

Type	No.	Signal name	Function	Signal level	
Digital input signals	8	DigIn 1	RunL (reverse)	High > 9 VDC Low < 4 VDC Max 30 VDC Impedance 4.7 kΩ for < 3.3 VDC 3.6 kΩ for > 3.3 VDC	
	9	DigIn 2	RunR (forward)		
	10	DigIn 3	Off		
	16	DigIn 4	Off		
	17	DigIn 5	Off		
	18	DigIn 6	Off		
	19	DigIn 7	Off		
	22	DigIn 8	RESET		
	11	+24 V	+24 VDC supply voltage	Max 100mA	
15	Common	Signal ground			
Analog input signals	1	+10 V	+10 VDC supply voltage	-10 to 10 VDC 0 to 20mA Max 30V/30mA Impedance 20 kΩ Voltage 250 Ω Current	
	2	AnIn 1	Process Ref		
	3	AnIn 2	Off		
	4	AnIn 3	Off		
	5	AnIn 4	Off		
	6	-10 V	-10 VDC supply voltage		
	7	Common	Signal ground		
Digital output signals	20	DigOut 1	Ready	High > 20VDC @50mA > 23VDC open Low <1 VDC @ 50mA 100 mA max together with +24VDC	
	21	DigOut 2	Brake		
	12	Common	Signal ground		
	31	N/C 1	Relay 1 output Trip, active when the VSD is in a TRIP condition.	0.1 to 2A 250 VAC or 42 VDC	
	32	COM 1			
	33	N/O 1			
	41	N/C 2	Relay 2 output Run, active when the VSD is started.		
	42	COM 2			
	43	N/O 2			
	51	COM 3	Relay 3 output Off		
52	N/O 3				
Analog output signals	12	Common	Signal ground		0 - 10V / 0 - 20mA Max -15V @ 5mA Impedance: 10 Ω (Voltage)
	13	AnOut1	Min speed to max speed		
	14	AnOut2	0 to max torque		

Ordering information

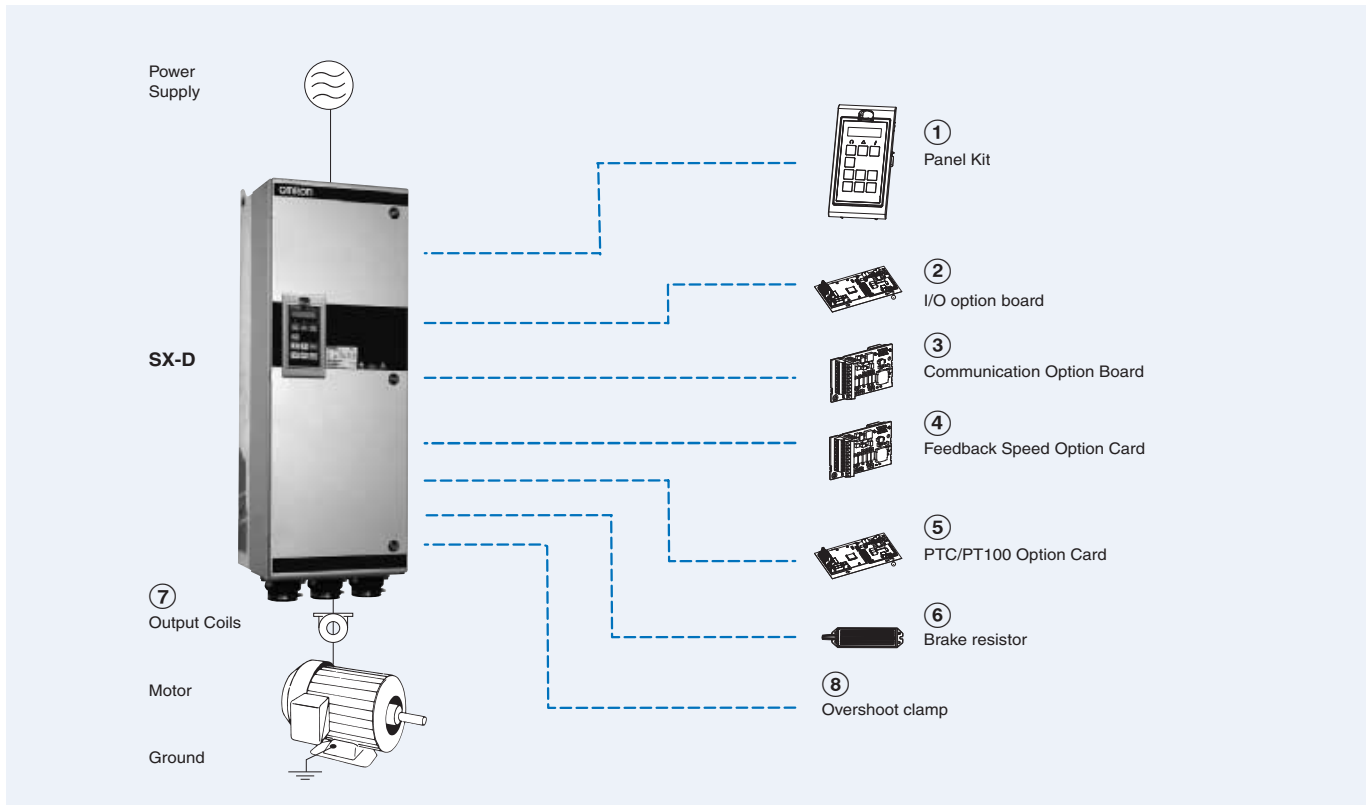

SX

Specifications				IP54 Model		IP20 Model		
Voltage	Heavy Duty		Normal Duty		Direct torque control	V/F	Direct torque control	V/F
400 V	0.55 kW	2.0 A	0.75 kW	2.5 A	SX-D40P7-EF	SX-D40P7-EV		
	1.1 kW	3.2 A	1.5 kW	4.0 A	SX-D41P5-EF	SX-D41P5-EV		
	1.5 kW	4.8 A	2.2 kW	6.0 A	SX-D42P2-EF	SX-D42P2-EV		
	2.2 kW	6.0 A	3 kW	7.5 A	SX-D43P0-EF	SX-D43P0-EV		
	3 kW	7.6 A	4 kW	9.5 A	SX-D44P0-EF	SX-D44P0-EV		
	4 kW	10.4 A	5.5 kW	13 A	SX-D45P5-EF	SX-D45P5-EV		
	5.5 kW	14.4 A	7.5 kW	18 A	SX-D47P5-EF	SX-D47P5-EV		
	7.5 kW	21 A	11 kW	26 A	SX-D4011-EF	SX-D4011-EV		
	11 kW	25 A	15 kW	31 A	SX-D4015-EF	SX-D4015-EV		
	15 kW	29.6 A	18.5 kW	37 A	SX-D4018-EF	SX-D4018-EV		
	18.5 kW	37 A	22 kW	46 A	SX-D4022-EF	SX-D4022-EV		
	22 kW	49 A	30 kW	61 A	SX-D4030-EF	SX-D4030-EV		
	30 kW	59 A	37 kW	74 A	SX-D4037-EF	SX-D4037-EV		
	37 kW	72 A	45 kW	90 A	SX-D4045-EF	SX-D4045-EV		
	45 kW	87 A	55 kW	109 A	SX-D4055-EF	SX-D4055-EV		
	55 kW	117 A	75 kW	146 A	SX-D4075-EF	SX-D4075-EV		
	75 kW	140 A	90 kW	175 A	SX-D4090-EF	SX-D4090-EV		
	90 kW	168 A	110 kW	210 A	SX-D4110-EF	SX-D4110-EV		
	110 kW	200 A	132 kW	250 A	SX-D4132-EF	SX-D4132-EV		
	132 kW	240 A	160 kW	300 A	SX-D4160-EF	SX-D4160-EV	SX-A4160-EF	SX-A4160-EV
	160 kW	300 A	200 kW	375 A	SX-D4200-EF	SX-D4200-EV	SX-A4200-EF	SX-A4200-EV
	200 kW	344 A	220 kW	430 A	SX-D4220-EF	SX-D4220-EV	SX-A4220-EF	SX-A4220-EV
	220 kW	400 A	250 kW	500 A	SX-D4250-EF	SX-D4250-EV	SX-A4250-EF	SX-A4250-EV
	250 kW	480 A	315 kW	600 A	SX-D4315-EF	SX-D4315-EV	SX-A4315-EF	SX-A4315-EV
315 kW	520 A	355 kW	650 A	SX-D4355-EF	SX-D4355-EV	SX-A4355-EF	SX-A4355-EV	
355 kW	600 A	400 kW	750 A	SX-D4400-EF	SX-D4400-EV	SX-A4400-EF	SX-A4400-EV	
400 kW	688 A	450 kW	680 A	SX-D4450-EF	SX-D4450-EV	SX-A4450-EF	SX-A4450-EV	
450 kW	800 A	500 kW	1000 A	SX-D4500-EF	SX-D4500-EV	SX-A4500-EF	SX-A4500-EV	
500 kW	960 A	630 kW	1200 A	SX-D4630-EF	SX-D4630-EV	SX-A4630-EF	SX-A4630-EV	
630 kW	1200 A	800 kW	1500 A	SX-D4800-EF	SX-D4800-EV	SX-A4800-EF	SX-A4800-EV	

① Panel Kit

Model	Description	Function
01-3957-00	Panel kit	Panel kit complete including panel
01-3957-01	Blank panel kit	Panel kit complete including blank panel

② I/O option board

Model	Description	Function
01-3876-01	Additional I/O option	Provides 3 extra relay outputs and 3 additional digital inputs
01-3876-07	Crane option	Dedicated option board for crane application, including additional I/O and functions

③ Communication option board

Type	Model	Description	Function
Communication option board	01-3876-04	RS232/485	• MODBUS RTU serial communication by RS232 or RS485 interface with galvanic isolation
	01-3876-05	PROFIBUS-DP option card	• Used for operating the inverter through PROFIBUS-DP communication with the host controller.
	01-3876-06	DeviceNet option card	• Used for operating the inverter through DeviceNet communication with the host controller.
	01-3876-09	Modbus/TCP, Ethernet	• Used for operating the inverter through Modbus/TCP communication with the host controller.

④ Encoder feedback option card

Model	Description	Function
01-3876-03	Encoder option	Used for connection of the actual motor speed via encoder. Up to 100kHz with TTL and HTL incremental encoders with 5/24 V power supply

⑤ PTC/PT100 option card

Model	Description	Function
01-3876-08	Thermal protection	Allows to connect a motor thermistor to the inverter

⑥ Braking chopper and braking resistor

All inverter sizes could be fitted with an optional built-in brake chopper from factory but is not possible to install it later. The choice of the resistor depends on the application switch-on duration and duty-cycle. Following tables describes the activation level of the built-in braking chopper and the minimum resistor that could be used depending on the input voltage.

Type	R for different input voltage (Ω)			Type	R for different input voltage (Ω)		
	220-240 VAC	380-415 VAC	440-480 VAC		220-240 VAC	380-415 VAC	440-480 VAC
SX-40P7	43	43	50	SX-4075	3.8	3.8	4.4
SX-41P5	43	43	50	SX-4090	3.8	3.8	4.4
SX-42P2	43	43	50	SX-4110	2.7	2.7	3.1
SX-43P0	43	43	50	SX-4132	2.7	2.7	3.1
SX-44P0	43	43	50	SX-4160	2 x 3.8	2 x 3.8	2 x 4.4
SX-45P5	43	43	50	SX-4200	2 x 3.8	2 x 3.8	2 x 4.4
SX-47P5	43	43	50	SX-4220	2 x 2.7	2 x 2.7	2 x 3.1
SX-4011	26	26	30	SX-4250	2 x 2.7	2 x 2.7	2 x 3.1
SX-4015	26	26	30	SX-4315	3 x 2.7	3 x 2.7	3 x 3.1
SX-4018	17	17	20	SX-4355	3 x 2.7	3 x 2.7	3 x 3.1
SX-4022	17	17	20	SX-4400	3 x 2.7	3 x 2.7	3 x 3.1
SX-4030	9.7	9.7	N/A	SX-4450	4 x 2.7	4 x 2.7	4 x 3.1
SX-4037	9.7	9.7	N/A	SX-4500	4 x 2.7	4 x 2.7	4 x 3.1
SX-4045	3.8	3.8	4.4	SX-4630	6 x 2.7	6 x 2.7	6 x 3.1
SX-4055	3.8	3.8	4.4		-	-	-

Supply voltage (VAC)	Built-in brake chopper trigger level (VDC)
220-240	380
380-415	660
440-480	780

⑦ Output coils

Output coils above SX-D4132-E should be order from factory as they should be installed inside of the cabinet

Voltage	Inverter model	Model	Rated current	Inductance	Rated Voltage	Max carrier	Max output frequency	Max temp
400V	SX-40P7-E	473160 00	2.8A	1.5 mH	800V	10 KHz	200	40°C
	SX-41P5-E	473161 00	4.4A	1.0 mH				
	SX-42P2-E	473162 00	6.6A	0.65 mH				
	SX-43P0-E	473163 00	11.0A	0.4 mH				
	SX-44P0-E							
	SX-45P5-E	473164 00	14.3A	0.3 mH				
	SX-47P5-E	473165 00	18.2A	0.25 mH				
	SX-4011-E	473166 00	26.4A	0.175 mH				
	SX-4015-E	473167 00	32A	0.15 mH				
	SX-4018-E	473168 00	65A	0.1 mH				
	SX-4022-E							
	SX-4030-E							
	SX-4037-E	473169 00	90A	0.1 mH				
	SX-4045-E							
	SX-4055-E	473170 00	146A	0.05 mH				
	SX-4075-E							
	SX-4090-E	473171 00	175A	0.05 mH				
SX-4110-E	473172 00	275A	0.032 mH					
SX-4132-E								
						6 KHz		
						1.5 KHz	100	

⑧ Overshoot clamp

Only two types of overshoot clamps could be order for after mounting

Model	Inverter	Function
52163	SX-40P7 to SX-4132	Together with the output coils, the overshoot clamp restricts the voltage and the dV/dt on the motor winding. Inverters must be ordered including the option DC+/DC- connectors.
52220	SX-4160 to SX-4800	Together with the output coils, the overshoot clamp restricts the voltage and the dV/dt on the motor winding. Doesn't require the "DC+/DC-" option.

Computer software

Types	Model	Description	Installation
Software	CX-drive	Computer software	Configuration and monitoring software tool
	CX-One	Computer software	Configuration and monitoring software tool
	€Saver	Computer software	Software tool for Energy Saving calculation

ALL DIMENSIONS SHOWN ARE IN MILLIMETERS.
To convert millimeters into inches, multiply by 0.03937. To convert grams into ounces, multiply by 0.03527.