

## FLOOR STANDING ENCLOSURES SERIES OK IP55

The new series of assemblable enclosures OK is the latest product developed by Quadritalia, it is the result of a revolutionary technical project and of the newest solutions developed by our R&D Department.

The dismantable frame is made up of symmetrical elements in Sendzimir, which are manufactured on a profiling line and have no welded parts, and are not painted, ensuring a high EMC compatibility. Together with the patented

orthogonal corner joint in zamak alloy, these elements guarantee the utmost stiffness of the OK structure.

The OK series enclosures are available in two versions: pre-assembled (OKB), and disassembled supplied in flat pack (OKK). Both these versions can be ordered in all the configurations shown in the present catalogue, suitable for the automation and power distribution market.



### General **technical characteristics:**

- Degree of protection: IP55, complying with IEC EN60529
- Degree of protection against impacts: IK10, complying with EN50102
- Nema type 12, complying with CSA 22.2, 94-1 and 94-2, UL 50 and UL 50E
- Panels painted RAL 7035 textured finish, epoxy polyester powder coating
- Plinth painted RAL9005 textured finish, epoxy polyester powder coating
- Thickness sheet of external panels: 1.5 mm
- Thickness sheet of doors: 2.0 mm
- Thickness sheet of mounting plates: 2.5 mm

## OK K - Disassembled enclosure frame

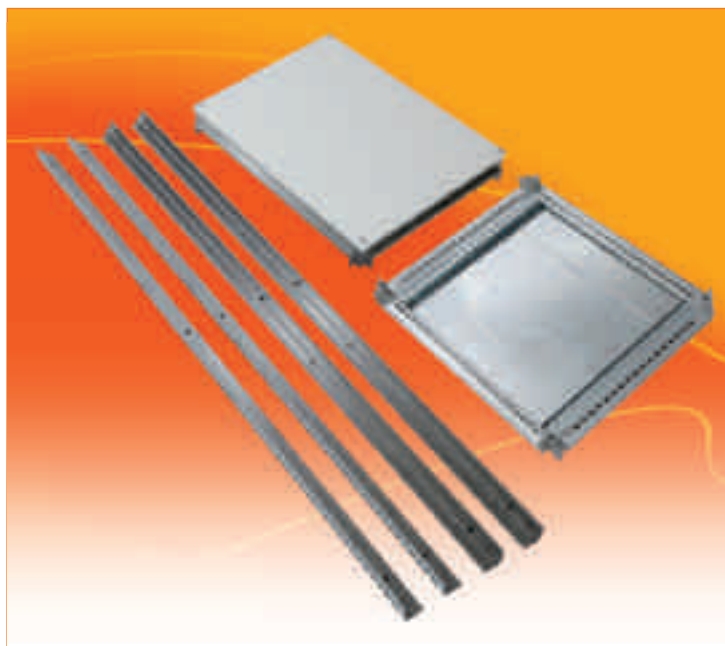

**Frame supplied as flat pack**, includes:

- Set of 4 vertical uprights
- Pre-assembled base element with adjustable cable entry flanges
- Pre-assembled top element with removable panel
- Assembling hardware
- Assembling instructions booklet

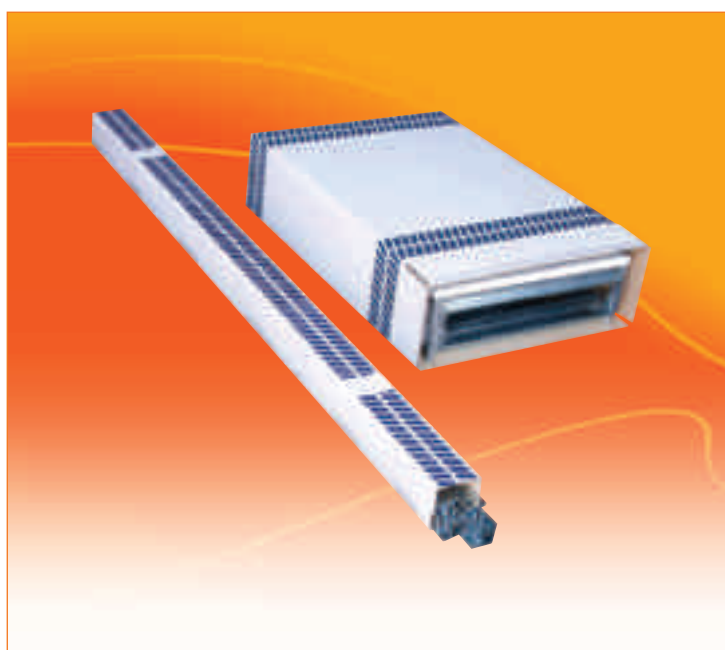

**Supply:**

- 1 pack for the set of vertical uprights
- 1 pack for top and base elements

**Completing elements** to be ordered separately (single packaging):

- Blind door ..... **DBE** (page 18)
- Rear panel..... **RPE** (page 19)
- Mounting plate..... **PNA** (page 20)
- Pair of side panels..... **DLK** (page 21)
- Plinth ..... **ZAK & FLK** (pages 22 and 23)
- Accessories

**Note:** for dimensions available, see pages 10-15, for data sheets see page 167 and following.

**OK B - Pre-assembled enclosure**



**Description:** complete pre-assembled frame, including top removable panel and adjustable cable entry flanges, blind door 2.0 mm thick, with 3.0 mm double bar locking system, rear panel 2.0 mm thick and mounting plate 2.5 mm thick.

**Paint:** epoxy-polyester powder coating, RAL 7035 textured finish (all external panels)

**Supply:** 1pack, mounting plate installed in intermediate position inside the enclosure

**Common completing elements:**

- Plinth.....**ZAK + FLK** (pages 22-23)
- Pair of side panels .....**DLK** (page 21)



**DTE**

**More additional elements** available:

- Glazed door **DTE** .....(page 24)
- Inner door **DBI** .....(page 25)
- Side door **FPK** .....(page 51)
- Single side panel **SLK** .....(page 21)
- Wide mounting plate **PMB** .....(page 27)
- Modular elements .....(page 38)
- Lifting eyebolts .....(page 121)
- Baying kit .....(page 57)
- Other accessories, inner profiles, brackets etc.

**Note:** for details on dimensions available, see pages 16-17, for information on nominal and real dimensions see pages 167-172, for data sheets see page 166 and following.



**DLK**



**ZAK**

**How to order a complete enclosure in flat pack version OKK:**

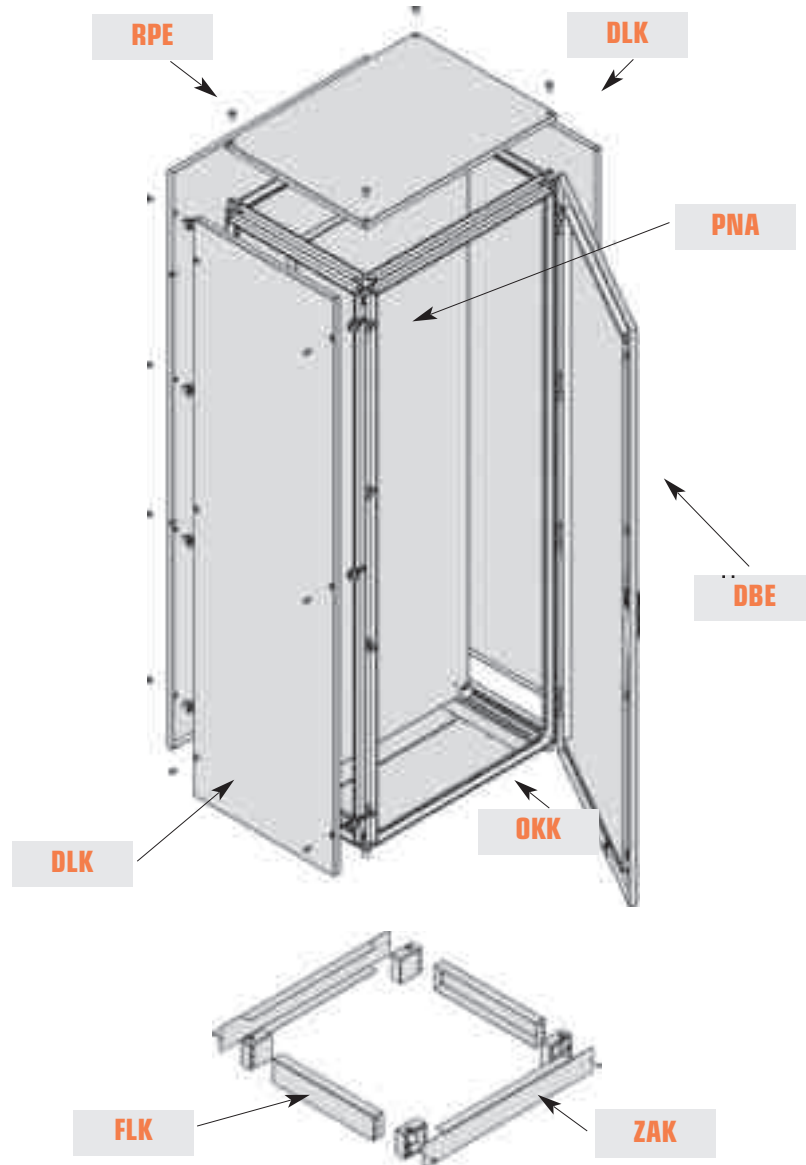

- OKK Disassembled frame complete with top and bottom elements
- DBE Blind door
- RPE Rear panel
- PNA Mounting plate
- DLK Pair of side panels
- ZAK Plinth complete with 4 corner elements, front and rear flanges
- FLK Pair of side flanges for plinth



**Example:**

Complete enclosure h=2000 w=800 d=600 mm:

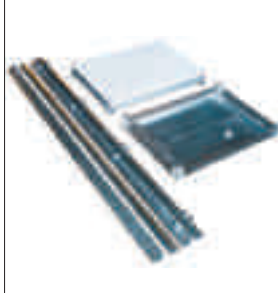

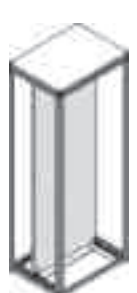

- OKK2086** (2000 x 800 x 600) complete frame with removable top and adjustable gland plates
- DBE208** (2000 x 800) blind door
- RPE208** (2000 x 800) rear panel
- PNA208** (2000 x 800) mounting plate
- DLK206** (2000 x 600) pair of side panels
- ZAK081** (800 x 100) plinth h=100 mm with 4 corner elements, front and rear plates
- FLK16** (100 x 600) side flanges for plinth h=100 mm

| DIMENSIONS  | TOP AND BASE ELEMENTS, UPRIGHTS   | BLIND DOOR  | REAR PANEL   | MOUNTING PLATE  |
|---|---|---|--|---|
|  |  |  |  |  |
| HxWxD   | Cat. page 7   | Cat. page 18  | Cat. page 19   | Cat. page 20  |
| 1600X600X400  | OKK1664   | DBE166  | RPE166   | PNA166  |
| 1600X600X500  | OKK1665   | DBE166  | RPE166   | PNA166  |
| 1600X600X600  | OKK1666   | DBE166  | RPE166   | PNA166  |
| 1600X800X400  | OKK1684   | DBE168  | RPE168   | PNA168  |
| 1600X800X500  | OKK1685   | DBE168  | RPE168   | PNA168  |
| 1600X800X600  | OKK1686   | DBE168  | RPE168   | PNA168  |
| 1600X1000X400   | OKK16A4   | DBE16A  | RPE16A   | PNA16A  |
| 1600X1000X500   | OKK16A5   | DBE16A  | RPE16A   | PNA16A  |
| 1600X1000X600   | OKK16A6   | DBE16A  | RPE16A   | PNA16A  |
| 1600X1200X400   | OKK16C4   | DBE16C  | RPE16C   | PNA16C  |
| 1600X1200X500   | OKK16C5   | DBE16C  | RPE16C   | PNA16C  |
| 1600X1200X600   | OKK16C6   | DBE16C  | RPE16C   | PNA16C  |
| 1800X400X400  | OKK1844   | DBE184  | RPE184   | PNA184  |
| 1800X400X500  | OKK1845   | DBE184  | RPE184   | PNA184  |
| 1800X400X600  | OKK1846   | DBE184  | RPE184   | PNA184  |
| 1800X400X800  | OKK1848   | DBE184  | RPE184   | PNA184  |
| 1800X600X400  | OKK1864   | DBE186  | RPE186   | PNA186  |
| 1800X600X500  | OKK1865   | DBE186  | RPE186   | PNA186  |
| 1800X600X600  | OKK1866   | DBE186  | RPE186   | PNA186  |
| 1800X600X800  | OKK1868   | DBE186  | RPE186   | PNA186  |
| 1800X800X400  | OKK1884   | DBE188  | RPE188   | PNA188  |
| 1800X800X500  | OKK1885   | DBE188  | RPE188   | PNA188  |
| 1800X800X600  | OKK1886   | DBE188  | RPE188   | PNA188  |
| 1800X800X800  | OKK1888   | DBE188  | RPE188   | PNA188  |
| 1800X800X1000   | OKK188A   | DBE188  | RPE188   | PNA188  |
| 1800X1000X400   | OKK18A4   | DBE18A  | RPE18A   | PNA18A  |
| 1800X1000X500   | OKK18A5   | DBE18A  | RPE18A   | PNA18A  |
| 1800X1000X600   | OKK18A6   | DBE18A  | RPE18A   | PNA18A  |
| 1800X1000X800   | OKK18A8   | DBE18A  | RPE18A   | PNA18A  |
| 1800X1000X1000  | OKK18AA   | DBE18A  | RPE18A   | PNA18A  |
| 1800X1200X400   | OKK18C4   | DBE18C  | RPE18C   | PNA18C  |
| 1800X1200X500   | OKK18C5   | DBE18C  | RPE18C   | PNA18C  |
| 1800X1200X600   | OKK18C6   | DBE18C  | RPE18C   | PNA18C  |
| 1800X1200X800   | OKK18C8   | DBE18C  | RPE18C   | PNA18C  |
| 1800X1200X1000  | OKK18CA   | DBE18C  | RPE18C   | PNA18C  |
| 1800X1400X400   | OKK18D4   | DBE18D  | RPE18D   | PNA18D  |
| 1800X1400X500   | OKK18D5   | DBE18D  | RPE18D   | PNA18D  |
| 1800X1400X600   | OKK18D6   | DBE18D  | RPE18D   | PNA18D  |
| 1800X1400X800   | OKK18D8   | DBE18D  | RPE18D   | PNA18D  |
| 1800X1600X400   | OKK18E4   | DBE18E  | RPE18E   | PNA18E  |
| 1800X1600X500   | OKK18E5   | DBE18E  | RPE18E   | PNA18E  |
| 1800X1600X600   | OKK18E6   | DBE18E  | RPE18E   | PNA18E  |
| 1800X1600X800   | OKK18E8   | DBE18E  | RPE18E   | PNA18E  |
| 2000X400X400  | OKK2044   | DBE204  | RPE204   | PNA204  |
| 2000X400X500  | OKK2045   | DBE204  | RPE204   | PNA204  |
| 2000X400X600  | OKK2046   | DBE204  | RPE204   | PNA204  |
| 2000X400X800  | OKK2048   | DBE204  | RPE204   | PNA204  |
| 2000X600X400  | OKK2064   | DBE206  | RPE206   | PNA206  |
| 2000X600X500  | OKK2065   | DBE206  | RPE206   | PNA206  |
| 2000X600X600  | OKK2066   | DBE206  | RPE206   | PNA206  |
| 2000X600X800  | OKK2068   | DBE206  | RPE206   | PNA206  |
| 2000X600X1000   | OKK206A   | DBE206  | RPE206   | PNA206  |

**Note:** for more information on the characteristic dimensions of enclosures OKK and OKB, refer to pages 167-170

| DIMENSIONS     | PAIR OF SIDE PANELS | PLINTH H=100 | PLINTH H=200 | PAIR OF SIDE FLANGES FOR PLINTH H=100 | PAIR OF SIDE FLANGES FOR PLINTH H=200 |
|----------------|---------------------|--------------|--------------|---------------------------------------|---------------------------------------|
|                |                     |              |              |                                       |                                       |
| HxWxD          | Cat. page 21        | Cat. page 22 | Cat. page 23 | Cat. page 22                          | Cat. page 23                          |
| 1600X600X400   | DLK164              | ZAK061       | ZAK062       | FLK14                                 | FLK24                                 |
| 1600X600X500   | DLK165              | ZAK061       | ZAK062       | FLK15                                 | FLK25                                 |
| 1600X600X600   | DLK166              | ZAK061       | ZAK062       | FLK16                                 | FLK26                                 |
| 1600X800X400   | DLK164              | ZAK081       | ZAK082       | FLK14                                 | FLK24                                 |
| 1600X800X500   | DLK165              | ZAK081       | ZAK082       | FLK15                                 | FLK25                                 |
| 1600X800X600   | DLK166              | ZAK081       | ZAK082       | FLK16                                 | FLK26                                 |
| 1600x1000x400  | DLK164              | ZAK0A1       | ZAK0A2       | FLK14                                 | FLK24                                 |
| 1600x1000x500  | DLK165              | ZAK0A1       | ZAK0A2       | FLK15                                 | FLK25                                 |
| 1600x1000x600  | DLK166              | ZAK0A1       | ZAK0A2       | FLK16                                 | FLK26                                 |
| 1600X1200X400  | DLK164              | ZAK0C1       | ZAK0C2       | FLK14                                 | FLK24                                 |
| 1600X1200X500  | DLK165              | ZAK0C1       | ZAK0C2       | FLK15                                 | FLK25                                 |
| 1600X1200X600  | DLK166              | ZAK0C1       | ZAK0C2       | FLK16                                 | FLK26                                 |
| 1800X400X400   | DLK184              | ZAK041       | ZAK042       | FLK14                                 | FLK24                                 |
| 1800X400X500   | DLK185              | ZAK041       | ZAK042       | FLK15                                 | FLK25                                 |
| 1800X400X600   | DLK186              | ZAK041       | ZAK042       | FLK16                                 | FLK26                                 |
| 1800X400X800   | DLK188              | ZAK041       | ZAK042       | FLK18                                 | FLK28                                 |
| 1800X600X400   | DLK184              | ZAK061       | ZAK062       | FLK14                                 | FLK24                                 |
| 1800X600X500   | DLK185              | ZAK061       | ZAK062       | FLK15                                 | FLK25                                 |
| 1800X600X600   | DLK186              | ZAK061       | ZAK062       | FLK16                                 | FLK26                                 |
| 1800X600X800   | DLK188              | ZAK061       | ZAK062       | FLK18                                 | FLK28                                 |
| 1800X800X400   | DLK184              | ZAK081       | ZAK082       | FLK14                                 | FLK24                                 |
| 1800X800X500   | DLK185              | ZAK081       | ZAK082       | FLK15                                 | FLK25                                 |
| 1800X800X600   | DLK186              | ZAK081       | ZAK082       | FLK16                                 | FLK26                                 |
| 1800X800X800   | DLK188              | ZAK081       | ZAK082       | FLK18                                 | FLK28                                 |
| 1800X800X1000  | DLK18A              | ZAK081       | ZAK082       | FLK1A                                 | FLK2A                                 |
| 1800X1000X400  | DLK184              | ZAK0A1       | ZAK0A2       | FLK14                                 | FLK24                                 |
| 1800X1000X500  | DLK185              | ZAK0A1       | ZAK0A2       | FLK15                                 | FLK25                                 |
| 1800X1000X600  | DLK186              | ZAK0A1       | ZAK0A2       | FLK16                                 | FLK26                                 |
| 1800X1000X800  | DLK188              | ZAK0A1       | ZAK0A2       | FLK18                                 | FLK28                                 |
| 1800X1000X1000 | DLK18A              | ZAK0A1       | ZAK0A2       | FLK1A                                 | FLK2A                                 |
| 1800X1200X400  | DLK184              | ZAK0C1       | ZAK0C2       | FLK14                                 | FLK24                                 |
| 1800X1200X500  | DLK185              | ZAK0C1       | ZAK0C2       | FLK15                                 | FLK25                                 |
| 1800X1200X600  | DLK186              | ZAK0C1       | ZAK0C2       | FLK16                                 | FLK26                                 |
| 1800X1200X800  | DLK188              | ZAK0C1       | ZAK0C2       | FLK18                                 | FLK28                                 |
| 1800X1200X1000 | DLK18A              | ZAK0C1       | ZAK0C2       | FLK1A                                 | FLK2A                                 |
| 1800X1400X400  | DLK184              | ZAK0D1       | ZAK0D2       | FLK14                                 | FLK24                                 |
| 1800X1400X500  | DLK185              | ZAK0D1       | ZAK0D2       | FLK15                                 | FLK25                                 |
| 1800X1400X600  | DLK186              | ZAK0D1       | ZAK0D2       | FLK16                                 | FLK26                                 |
| 1800X1400X800  | DLK188              | ZAK0D1       | ZAK0D2       | FLK18                                 | FLK28                                 |
| 1800X1600X400  | DLK184              | ZAK0E1       | ZAK0E2       | FLK14                                 | FLK24                                 |
| 1800X1600X500  | DLK185              | ZAK0E1       | ZAK0E2       | FLK15                                 | FLK25                                 |
| 1800X1600X600  | DLK186              | ZAK0E1       | ZAK0E2       | FLK16                                 | FLK26                                 |
| 1800X1600X800  | DLK188              | ZAK0E1       | ZAK0E2       | FLK18                                 | FLK28                                 |
| 2000X400X400   | DLK204              | ZAK041       | ZAK042       | FLK14                                 | FLK24                                 |
| 2000X400X500   | DLK205              | ZAK041       | ZAK042       | FLK15                                 | FLK25                                 |
| 2000X400X600   | DLK206              | ZAK041       | ZAK042       | FLK16                                 | FLK26                                 |
| 2000X400X800   | DLK208              | ZAK041       | ZAK042       | FLK18                                 | FLK28                                 |
| 2000X600X400   | DLK204              | ZAK061       | ZAK062       | FLK14                                 | FLK24                                 |
| 2000X600X500   | DLK205              | ZAK061       | ZAK062       | FLK15                                 | FLK25                                 |
| 2000X600X600   | DLK206              | ZAK061       | ZAK062       | FLK16                                 | FLK26                                 |
| 2000X600X800   | DLK208              | ZAK061       | ZAK062       | FLK18                                 | FLK28                                 |
| 2000X600X1000  | DLK20A              | ZAK061       | ZAK062       | FLK1A                                 | FLK2A                                 |

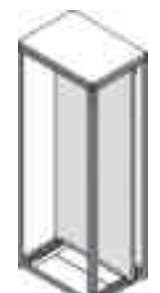
**Note:** for more information on the characteristic dimensions of enclosures OKK and OKB, refer to pages 166-170





| DIMENSIONS  | GLAZED DOOR   | INNER DOOR  | WIDE MOUNTING PLATE  | PLATE FILLER  |
|---|---|---|--|---|
|  |  |  |  |  |
| HxWxD   | Cat. page 24  | Cat. page 25  | Cat. page 27   | Cat. page 28  |
| 1600X600X400  | DTE166  | DBI166  | PMB166   | FUP160  |
| 1600X600X500  | DTE166  | DBI166  | PMB166   | FUP168  |
| 1600X600X600  | DTE166  | DBI166  | PMB166   | FUP168  |
| 1600X800X400  | DTE168  | DBI168  | PMB168   | FUP168  |
| 1600X800X500  | DTE168  | DBI168  | PMB168   | FUP168  |
| 1600X800X600  | DTE168  | DBI168  | PMB168   | FUP168  |
| 1600X1000X400   | DTE16A  | DBI16A  | PMB16A   | FUP168  |
| 1600X1000X500   | DTE16A  | DBI16A  | PMB16A   | FUP168  |
| 1600X1000X600   | DTE16A  | DBI16A  | PMB16A   | FUP168  |
| 1600X1200X400   | DTE16C  | DBI16C  | PMB16C   | FUP168  |
| 1600X1200X500   | DTE16C  | DBI16C  | PMB16C   | FUP168  |
| 1600X1200X600   | DTE16C  | DBI16C  | PMB16C   | FUP168  |
| 1800X400X400  |   |   | PMB184   | FUP188  |
| 1800X400X500  |   |   | PMB184   | FUP188  |
| 1800X400X600  |   |   | PMB184   | FUP180  |
| 1800X400X800  |   |   | PMB184   | FUP180  |
| 1800X600X400  | DTE186  | DBI186  | PMB186   | FUP180  |
| 1800X600X500  | DTE186  | DBI186  | PMB186   | FUP188  |
| 1800X600X600  | DTE186  | DBI186  | PMB186   | FUP188  |
| 1800X600X800  | DTE186  | DBI186  | PMB186   | FUP188  |
| 1800X800X400  | DTE188  | DBI188  | PMB188   | FUP188  |
| 1800X800X500  | DTE188  | DBI188  | PMB188   | FUP188  |
| 1800X800X600  | DTE188  | DBI188  | PMB188   | FUP188  |
| 1800X800X800  | DTE188  | DBI188  | PMB188   | FUP188  |
| 1800X800X1000   | DTE188  | DBI188  | PMB188   | FUP188  |
| 1800X1000X400   | DTE18A  | DBI18A  | PMB18A   | FUP188  |
| 1800X1000X500   | DTE18A  | DBI18A  | PMB18A   | FUP188  |
| 1800X1000X600   | DTE18A  | DBI18A  | PMB18A   | FUP188  |
| 1800X1000X800   | DTE18A  | DBI18A  | PMB18A   | FUP188  |
| 1800X1000X1000  | DTE18A  | DBI18A  | PMB18A   | FUP188  |
| 1800X1200X400   | DTE18C  | DBI18C  | PMB18C   | FUP188  |
| 1800X1200X500   | DTE18C  | DBI18C  | PMB18C   | FUP188  |
| 1800X1200X600   | DTE18C  | DBI18C  | PMB18C   | FUP188  |
| 1800X1200X800   | DTE18C  | DBI18C  | PMB18C   | FUP188  |
| 1800X1200X1000  | DTE18C  | DBI18C  | PMB18C   | FUP188  |
| 1800X1400X400   |   |   | PMB18D   | FUP188  |
| 1800X1400X500   |   |   | PMB18D   | FUP188  |
| 1800X1400X600   |   |   | PMB18D   | FUP188  |
| 1800X1400X800   |   |   | PMB18D   | FUP188  |
| 1800X1600X400   | DTE18E  |   | PMB18E   | FUP188  |
| 1800X1600X500   | DTE18E  |   | PMB18E   | FUP188  |
| 1800X1600X600   | DTE18E  |   | PMB18E   | FUP188  |
| 1800X1600X800   | DTE18E  |   | PMB18E   | FUP188  |
| 2000X400X400  |   |   | PMB204   | FUP208  |
| 2000X400X500  |   |   | PMB204   | FUP208  |
| 2000X400X600  |   |   | PMB204   | FUP208  |
| 2000X400X800  |   |   | PMB204   | FUP200  |
| 2000X600X400  | DTE206  | DBI206  | PMB206   | FUP200  |
| 2000X600X500  | DTE206  | DBI206  | PMB206   | FUP208  |
| 2000X600X600  | DTE206  | DBI206  | PMB206   | FUP208  |
| 2000X600X800  | DTE206  | DBI206  | PMB206   | FUP208  |
| 2000X600X1000   | DTE206  | DBI206  | PMB206   | FUP208  |

**Note:** for more information on the characteristic dimensions of enclosures OKK and OKB, refer to pages 166-170

| DIMENSIONS     | TOP AND BASE ELEMENTS, UPRIGHTS | BLIND DOOR   | REAR PANEL   | MOUNTING PLATE |
|----------------|---------------------------------|--------------|--------------|----------------|
|                |                                 |              |              |                |
| HxWxD          | Cat. page 7                     | Cat. page 18 | Cat. page 19 | Cat. page 20   |
| 2000X800X400   | OKK2084                         | DBE208       | RPE208       | PNA208         |
| 2000X800X500   | OKK2085                         | DBE208       | RPE208       | PNA208         |
| 2000X800X600   | OKK2086                         | DBE208       | RPE208       | PNA208         |
| 2000X800X800   | OKK2088                         | DBE208       | RPE208       | PNA208         |
| 2000X800X1000  | OKK208A                         | DBE208       | RPE208       | PNA208         |
| 2000X1000X400  | OKK20A4                         | DBE20A       | RPE20A       | PNA20A         |
| 2000X1000X500  | OKK20A5                         | DBE20A       | RPE20A       | PNA20A         |
| 2000X1000X600  | OKK20A6                         | DBE20A       | RPE20A       | PNA20A         |
| 2000X1000X800  | OKK20A8                         | DBE20A       | RPE20A       | PNA20A         |
| 2000X1000X1000 | OKK20AA                         | DBE20A       | RPE20A       | PNA20A         |
| 2000X1200X400  | OKK20C4                         | DBE20C       | RPE20C       | PNA20C         |
| 2000X1200X500  | OKK20C5                         | DBE20C       | RPE20C       | PNA20C         |
| 2000X1200X600  | OKK20C6                         | DBE20C       | RPE20C       | PNA20C         |
| 2000X1200X800  | OKK20C8                         | DBE20C       | RPE20C       | PNA20C         |
| 2000X1200X1000 | OKK20CA                         | DBE20C       | RPE20C       | PNA20C         |
| 2000X1400X400  | OKK20D4                         | DBE20D       | RPE20D       | PNA20D         |
| 2000X1400X500  | OKK20D5                         | DBE20D       | RPE20D       | PNA20D         |
| 2000X1400X600  | OKK20D6                         | DBE20D       | RPE20D       | PNA20D         |
| 2000X1400X800  | OKK20D8                         | DBE20D       | RPE20D       | PNA20D         |
| 2000X1600X400  | OKK20E4                         | DBE20E       | RPE20E       | PNA20E         |
| 2000X1600X500  | OKK20E5                         | DBE20E       | RPE20E       | PNA20E         |
| 2000X1600X600  | OKK20E6                         | DBE20E       | RPE20E       | PNA20E         |
| 2000X1600X800  | OKK20E8                         | DBE20E       | RPE20E       | PNA20E         |
| 2200X600X400   | OKK2264                         | DBE226       | RPE226       | PNA226         |
| 2200X600X500   | OKK2265                         | DBE226       | RPE226       | PNA226         |
| 2200X600X600   | OKK2266                         | DBE226       | RPE226       | PNA226         |
| 2200X600X800   | OKK2268                         | DBE226       | RPE226       | PNA226         |
| 2200X600X1000  | OKK226A                         | DBE226       | RPE226       | PNA226         |
| 2200X800X400   | OKK2284                         | DBE228       | RPE228       | PNA228         |
| 2200X800X500   | OKK2285                         | DBE228       | RPE228       | PNA228         |
| 2200X800X600   | OKK2286                         | DBE228       | RPE228       | PNA228         |
| 2200X800X800   | OKK2288                         | DBE228       | RPE228       | PNA228         |
| 2200X800X1000  | OKK228A                         | DBE228       | RPE228       | PNA228         |
| 2200X1000X400  | OKK22A4                         | DBE22A       | RPE22A       | PNA22A         |
| 2200X1000X500  | OKK22A5                         | DBE22A       | RPE22A       | PNA22A         |
| 2200X1000X600  | OKK22A6                         | DBE22A       | RPE22A       | PNA22A         |
| 2200X1000X800  | OKK22A8                         | DBE22A       | RPE22A       | PNA22A         |
| 2200X1000X1000 | OKK22AA                         | DBE22A       | RPE22A       | PNA22A         |
| 2200X1200X400  | OKK22C4                         | DBE22C       | RPE22C       | PNA22C         |
| 2200X1200X500  | OKK22C5                         | DBE22C       | RPE22C       | PNA22C         |
| 2200X1200X600  | OKK22C6                         | DBE22C       | RPE22C       | PNA22C         |
| 2200X1200X800  | OKK22C8                         | DBE22C       | RPE22C       | PNA22C         |
| 2200X1200X1000 | OKK22CA                         | DBE22C       | RPE22C       | PNA22C         |
| 2200X1400X500  | OKK22D5                         | DBE22D       | RPE22D       | PNA22D         |
| 2200X1400X600  | OKK22D6                         | DBE22D       | RPE22D       | PNA22D         |
| 2200X1400X800  | OKK22D8                         | DBE22D       | RPE22D       | PNA22D         |
| 2200X1600X500  | OKK22E5                         | DBE22E       | RPE22E       | PNA22E         |
| 2200X1600X600  | OKK22E6                         | DBE22E       | RPE22E       | PNA22E         |
| 2200X1600X800  | OKK22E8                         | DBE22E       | RPE22E       | PNA22E         |

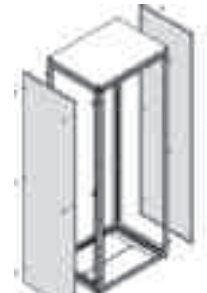
Note: for more information on the characteristic dimensions of enclosures OKK and OKB, refer to pages 166-170







| DIMENSIONS  | PAIR OF SIDE PANELS   | PLINTH H=100  | PLINTH H=200   | PAIR OF SIDE FLANGES FOR PLINTH H=100   | PAIR OF SIDE FLANGES FOR PLINTH H=200   |
|---|---|---|--|---|---|
|  |  |  |  |  |  |
| HxWxD   | Cat. page 21  | Cat. page 22  | Cat. page 23   | Cat. page 22  | Cat. page 23  |
| 2000X800X400  | DLK204  | ZAK081  | ZAK082   | FLK14   | FLK24   |
| 2000X800X500  | DLK205  | ZAK081  | ZAK082   | FLK15   | FLK25   |
| 2000X800X600  | DLK206  | ZAK081  | ZAK082   | FLK16   | FLK26   |
| 2000X800X800  | DLK208  | ZAK081  | ZAK082   | FLK18   | FLK28   |
| 2000X800X1000   | DLK20A  | ZAK081  | ZAK082   | FLK1A   | FLK2A   |
| 2000X1000X400   | DLK204  | ZAK0A1  | ZAK0A2   | FLK14   | FLK24   |
| 2000X1000X500   | DLK205  | ZAK0A1  | ZAK0A2   | FLK15   | FLK25   |
| 2000X1000X600   | DLK206  | ZAK0A1  | ZAK0A2   | FLK16   | FLK26   |
| 2000X1000X800   | DLK208  | ZAK0A1  | ZAK0A2   | FLK18   | FLK28   |
| 2000X1000X1000  | DLK20A  | ZAK0A1  | ZAK0A2   | FLK1A   | FLK2A   |
| 2000X1200X400   | DLK204  | ZAK0C1  | ZAK0C2   | FLK14   | FLK24   |
| 2000X1200X500   | DLK205  | ZAK0C1  | ZAK0C2   | FLK15   | FLK25   |
| 2000X1200X600   | DLK206  | ZAK0C1  | ZAK0C2   | FLK16   | FLK26   |
| 2000X1200X800   | DLK208  | ZAK0C1  | ZAK0C2   | FLK18   | FLK28   |
| 2000X1200X1000  | DLK20A  | ZAK0C1  | ZAK0C2   | FLK1A   | FLK2A   |
| 2000X1400X400   | DLK204  | ZAK0D1  | ZAK0D2   | FLK14   | FLK24   |
| 2000X1400X500   | DLK205  | ZAK0D1  | ZAK0D2   | FLK15   | FLK25   |
| 2000X1400X600   | DLK206  | ZAK0D1  | ZAK0D2   | FLK16   | FLK26   |
| 2000X1400X800   | DLK208  | ZAK0D1  | ZAK0D2   | FLK18   | FLK28   |
| 2000X1600X400   | DLK204  | ZAK0E1  | ZAK0E2   | FLK14   | FLK24   |
| 2000X1600X500   | DLK205  | ZAK0E1  | ZAK0E2   | FLK15   | FLK25   |
| 2000X1600X600   | DLK206  | ZAK0E1  | ZAK0E2   | FLK16   | FLK26   |
| 2000X1600X800   | DLK208  | ZAK0E1  | ZAK0E2   | FLK18   | FLK28   |
| 2200X600X400  | DLK224  | ZAK061  | ZAK062   | FLK14   | FLK24   |
| 2200X600X500  | DLK225  | ZAK061  | ZAK062   | FLK15   | FLK25   |
| 2200X600X600  | DLK226  | ZAK061  | ZAK062   | FLK16   | FLK26   |
| 2200X600X800  | DLK228  | ZAK061  | ZAK062   | FLK18   | FLK28   |
| 2200X600X1000   | DLK22A  | ZAK061  | ZAK062   | FLK1A   | FLK2A   |
| 2200X800X400  | DLK224  | ZAK081  | ZAK082   | FLK14   | FLK24   |
| 2200X800X500  | DLK225  | ZAK081  | ZAK082   | FLK15   | FLK25   |
| 2200X800X600  | DLK226  | ZAK081  | ZAK082   | FLK16   | FLK26   |
| 2200X800X800  | DLK228  | ZAK081  | ZAK082   | FLK18   | FLK28   |
| 2200X800X1000   | DLK22A  | ZAK081  | ZAK082   | FLK1A   | FLK2A   |
| 2200X1000X400   | DLK224  | ZAK0A1  | ZAK0A2   | FLK14   | FLK24   |
| 2200X1000X500   | DLK225  | ZAK0A1  | ZAK0A2   | FLK15   | FLK25   |
| 2200X1000X600   | DLK226  | ZAK0A1  | ZAK0A2   | FLK16   | FLK26   |
| 2200X1000X800   | DLK228  | ZAK0A1  | ZAK0A2   | FLK18   | FLK28   |
| 2200X1000X1000  | DLK22A  | ZAK0A1  | ZAK0A2   | FLK1A   | FLK2A   |
| 2200X1200X400   | DLK224  | ZAK0C1  | ZAK0C2   | FLK14   | FLK24   |
| 2200X1200X500   | DLK225  | ZAK0C1  | ZAK0C2   | FLK15   | FLK25   |
| 2200X1200X600   | DLK226  | ZAK0C1  | ZAK0C2   | FLK16   | FLK26   |
| 2200X1200X800   | DLK228  | ZAK0C1  | ZAK0C2   | FLK18   | FLK28   |
| 2200X1200X1000  | DLK22A  | ZAK0C1  | ZAK0C2   | FLK1A   | FLK2A   |
| 2200X1400X500   | DLK225  | ZAK0D1  | ZAK0D2   | FLK15   | FLK25   |
| 2200X1400X600   | DLK226  | ZAK0D1  | ZAK0D2   | FLK16   | FLK26   |
| 2200X1400X800   | DLK228  | ZAK0D1  | ZAK0D2   | FLK18   | FLK28   |
| 2200X1600X500   | DLK225  | ZAK0E1  | ZAK0E2   | FLK15   | FLK25   |
| 2200X1600X600   | DLK226  | ZAK0E1  | ZAK0E2   | FLK16   | FLK26   |
| 2200X1600X800   | DLK228  | ZAK0E1  | ZAK0E2   | FLK18   | FLK28   |

**Note:** for more information on the characteristic dimensions of enclosures OKK and OKB, refer to pages 166-170

| DIMENSIONS     | GLAZED DOOR  | INNER DOOR   | WIDE MOUNTING PLATE | PLATE FILLER |
|----------------|--------------|--------------|---------------------|--------------|
|                |              |              |                     |              |
| HxWxD          | Cat. page 24 | Cat. page 25 | Cat. page 27        | Cat. page 28 |
| 2000X800X400   | DTE208       | DBI208       | PMB208              | FUP208       |
| 2000X800X500   | DTE208       | DBI208       | PMB208              | FUP208       |
| 2000X800X600   | DTE208       | DBI208       | PMB208              | FUP208       |
| 2000X800X800   | DTE208       | DBI208       | PMB208              | FUP208       |
| 2000X800X1000  | DTE208       | DBI208       | PMB208              | FUP208       |
| 2000X1000X400  | DTE20A       | DBI20A       | PMB20A              | FUP208       |
| 2000X1000X500  | DTE20A       | DBI20A       | PMB20A              | FUP208       |
| 2000X1000X600  | DTE20A       | DBI20A       | PMB20A              | FUP208       |
| 2000X1000X800  | DTE20A       | DBI20A       | PMB20A              | FUP208       |
| 2000X1000X1000 | DTE20A       | DBI20A       | PMB20A              | FUP208       |
| 2000X1200X400  | DTE20C       | DBI20C       | PMB20C              | FUP208       |
| 2000X1200X500  | DTE20C       | DBI20C       | PMB20C              | FUP208       |
| 2000X1200X600  | DTE20C       | DBI20C       | PMB20C              | FUP208       |
| 2000X1200X800  | DTE20C       | DBI20C       | PMB20C              | FUP208       |
| 2000X1200X1000 | DTE20C       | DBI20C       | PMB20C              | FUP208       |
| 2000X1400X400  |              |              | PMB20D              | FUP208       |
| 2000X1400X500  |              |              | PMB20D              | FUP208       |
| 2000X1400X600  |              |              | PMB20D              | FUP208       |
| 2000X1400X800  |              |              | PMB20D              | FUP208       |
| 2000X1600X400  | DTE20E       | DBI20E       | PMB20E              | FUP208       |
| 2000X1600X500  | DTE20E       | DBI20E       | PMB20E              | FUP208       |
| 2000X1600X600  | DTE20E       | DBI20E       | PMB20E              | FUP208       |
| 2000X1600X800  | DTE20E       | DBI20E       | PMB20E              | FUP208       |
| 2200X600X400   | DTE226       | DBI226       | PMB226              | FUP228       |
| 2200X600X500   | DTE226       | DBI226       | PMB226              | FUP228       |
| 2200X600X600   | DTE226       | DBI226       | PMB226              | FUP228       |
| 2200X600X800   | DTE226       | DBI226       | PMB226              | FUP228       |
| 2200X600X1000  | DTE226       | DBI226       | PMB226              | FUP228       |
| 2200X800X400   | DTE228       | DBI228       | PMB228              | FUP228       |
| 2200X800X500   | DTE228       | DBI228       | PMB228              | FUP228       |
| 2200X800X600   | DTE228       | DBI228       | PMB228              | FUP228       |
| 2200X800X800   | DTE228       | DBI228       | PMB228              | FUP228       |
| 2200X800X1000  | DTE228       | DBI228       | PMB228              | FUP228       |
| 2200X1000X400  | DTE22A       | DBI22A       | PMB22A              | FUP228       |
| 2200X1000X500  | DTE22A       | DBI22A       | PMB22A              | FUP228       |
| 2200X1000X600  | DTE22A       | DBI22A       | PMB22A              | FUP228       |
| 2200X1000X800  | DTE22A       | DBI22A       | PMB22A              | FUP228       |
| 2200X1000X1000 | DTE22A       | DBI22A       | PMB22A              | FUP228       |
| 2200X1200X400  | DTE22C       | DBI22C       | PMB22C              | FUP228       |
| 2200X1200X500  | DTE22C       | DBI22C       | PMB22C              | FUP228       |
| 2200X1200X600  | DTE22C       | DBI22C       | PMB22C              | FUP228       |
| 2200X1200X800  | DTE22C       | DBI22C       | PMB22C              | FUP228       |
| 2200X1200X1000 | DTE22C       | DBI22C       | PMB22C              | FUP228       |
| 2200X1400X500  |              |              | PMB22D              | FUP228       |
| 2200X1400X600  |              |              | PMB22D              | FUP228       |
| 2200X1400X800  |              |              | PMB22D              | FUP228       |
| 2200X1600X500  | DTE22E       |              | PMB22E              | FUP228       |
| 2200X1600X600  | DTE22E       |              | PMB22E              | FUP228       |
| 2200X1600X800  | DTE22E       |              | PMB22E              | FUP228       |

Note: for more information on the characteristic dimensions of enclosures OKK and OKB, refer to pages 166-170

| DIMENSIONS  | ASSEMBLED FRAME WITH BLIND DOOR, REAR PANEL AND MOUNTING PLATE                    | ASSEMBLED FRAME WITH GLAZED DOOR, INNER DOOR, REAR PANEL AND M. PLATE             | ASSEMBLED FRAME WITH GLAZED DOOR, REAR PANEL AND RACK FRAME 19"                    | ASSEMBLED FRAME WITH GLAZED DOOR, REAR PANEL AND INTERNAL MODULAR FRAME             |
|---|---|---|--|---|
|  |  |  |  |  |
| HxWxD   | Cat. page 8   | Cat. page 29  | Cat. page 31   | Cat. page 34  |
| 1600X600X400  | OKB1664   | OKV1664   |  | OKD1664   |
| 1600X600X500  | OKB1665   | OKV1665   |  | OKD1665   |
| 1600X600X600  | OKB1666   | OKV1666   |  | OKD1666   |
| 1600X800X400  | OKB1684   | OKV1684   |  | OKD1684   |
| 1600X800X500  | OKB1685   | OKV1685   |  | OKD1685   |
| 1600X800X600  | OKB1686   | OKV1686   |  | OKD1686   |
| 1600X1000X400   | OKB16A4   |   |  |   |
| 1600X1000X500   | OKB16A5   |   |  |   |
| 1600X1000X600   | OKB16A6   |   |  |   |
| 1600X1200X400   | OKB16C4   |   |  |   |
| 1600X1200X500   | OKB16C5   |   |  |   |
| 1600X1200X600   | OKB16C6   |   |  |   |
| 1800X400X400  | OKB1844   |   |  |   |
| 1800X400X500  | OKB1845   |   |  |   |
| 1800X400X600  | OKB1846   |   |  |   |
| 1800X400X800  | OKB1848   |   |  |   |
| 1800X600X400  | OKB1864   | OKV1864   |  | OKD1864   |
| 1800X600X500  | OKB1865   | OKV1865   |  | OKD1865   |
| 1800X600X600  | OKB1866   | OKV1866   |  | OKD1866   |
| 1800X600X800  | OKB1868   | OKV1868   |  |   |
| 1800X800X400  | OKB1884   | OKV1884   | OKR1884  | OKD1884   |
| 1800X800X500  | OKB1885   | OKV1885   | OKR1885  | OKD1885   |
| 1800X800X600  | OKB1886   | OKV1886   | OKR1886  | OKD1886   |
| 1800X800X800  | OKB1888   | OKV1888   |  |   |
| 1800X800X1000   | OKB188A   | OKV188A   |  |   |
| 1800X1000X400   | OKB18A4   | OKV18A4   |  |   |
| 1800X1000X500   | OKB18A5   | OKV18A5   |  |   |
| 1800X1000X600   | OKB18A6   | OKV18A6   |  |   |
| 1800X1000X800   | OKB18A8   | OKV18A8   |  |   |
| 1800X1000X1000  | OKB18AA   | OKV18AA   |  |   |
| 1800X1200X400   | OKB18C4   | OKV18C4   |  |   |
| 1800X1200X500   | OKB18C5   | OKV18C5   |  |   |
| 1800X1200X600   | OKB18C6   | OKV18C6   |  |   |
| 1800X1200X800   | OKB18C8   | OKV18C8   |  |   |
| 1800X1200X1000  | OKB18CA   | OKV18CA   |  |   |
| 1800X1400X400   | OKB18D4   |   |  |   |
| 1800X1400X500   | OKB18D5   |   |  |   |
| 1800X1400X600   | OKB18D6   |   |  |   |
| 1800X1400X800   | OKB18D8   |   |  |   |
| 1800X1600X400   | OKB18E4   |   |  |   |
| 1800X1600X500   | OKB18E5   |   |  |   |
| 1800X1600X600   | OKB18E6   |   |  |   |
| 1800X1600X800   | OKB18E8   |   |  |   |
| 2000X400X400  | OKB2044   |   |  |   |
| 2000X400X500  | OKB2045   |   |  |   |
| 2000X400X600  | OKB2046   |   |  |   |
| 2000X400X800  | OKB2048   |   |  |   |
| 2000X600X400  | OKB2064   | OKV2064   |  | OKD2064   |
| 2000X600X500  | OKB2065   | OKV2065   |  | OKD2065   |
| 2000X600X600  | OKB2066   | OKV2066   |  | OKD2066   |
| 2000X600X800  | OKB2068   | OKV2068   |  | OKD2068   |
| 2000X600X1000   | OKB206A   | OKV206A   |  |   |

**Note:** for more information on the characteristic dimensions of enclosures OKV pag. 31; OKR, pag. 33, OKD, pag. 38

| DIMENSIONS     | ASSEMBLED FRAME WITH BLIND DOOR, REAR PANEL AND MOUNTING PLATE | ASSEMBLED FRAME WITH GLAZED DOOR, REAR PANEL, INNER DOOR AND M. PLATE | ASSEMBLED FRAME WITH GLAZED DOOR, REAR PANEL AND RACK FRAME 19" | ASSEMBLED FRAME WITH GLAZED DOOR, REAR PANEL AND INNER MODULAR FRAME |
|----------------|--|---|---|--|
|                |  |   |   |  |
| HxWxD          | Cat. page 8  | Cat. page 29  | Cat. page 31  | Cat. page 34   |
| 2000X800X400   | OKB2084  | OKV2084   | OKR2084   | OKD2084  |
| 2000X800X500   | OKB2085  | OKV2085   | OKR2085   | OKD2085  |
| 2000X800X600   | OKB2086  | OKV2086   | OKR2086   | OKD2086  |
| 2000X800X800   | OKB2088  | OKV2088   | OKR2088   | OKD2088  |
| 2000X800X1000  | OKB208A  | OKV208A   |   |  |
| 2000X1000X400  | OKB20A4  | OKV20A4   |   |  |
| 2000X1000X500  | OKB20A5  | OKV20A5   |   |  |
| 2000X1000X600  | OKB20A6  | OKV20A6   |   |  |
| 2000X1000X800  | OKB20A8  | OKV20A8   |   |  |
| 2000X1000X1000 | OKB20AA  | OKV20AA   |   |  |
| 2000X1200X400  | OKB20C4  | OKV20C4   |   |  |
| 2000X1200X500  | OKB20C5  | OKV20C5   |   |  |
| 2000X1200X600  | OKB20C6  | OKV20C6   |   |  |
| 2000X1200X800  | OKB20C8  | OKV20C8   |   |  |
| 2000X1200X1000 | OKB20CA  | OKV20CA   |   |  |
| 2000X1400X400  | OKB20D4  |   |   |  |
| 2000X1400X500  | OKB20D5  |   |   |  |
| 2000X1400X600  | OKB20D6  |   |   |  |
| 2000X1400X800  | OKB20D8  |   |   |  |
| 2000X1600X400  | OKB20E4  | OKV20E4   |   |  |
| 2000X1600X500  | OKB20E5  | OKV20E5   |   |  |
| 2000X1600X600  | OKB20E6  | OKV20E6   |   |  |
| 2000X1600X800  | OKB20E8  | OKV20E8   |   |  |
| 2200X600X400   | OKB2264  | OKV2264   |   |  |
| 2200X600X500   | OKB2265  | OKV2265   |   |  |
| 2200X600X600   | OKB2266  | OKV2266   |   | OKD2266  |
| 2200X600X800   | OKB2268  | OKV2268   |   |  |
| 2200X600X1000  | OKB226A  | OKV226A   |   |  |
| 2200X800X400   | OKB2284  | OKV2284   |   |  |
| 2200X800X500   | OKB2285  | OKV2285   |   |  |
| 2200X800X600   | OKB2286  | OKV2286   |   | OKD2286  |
| 2200X800X800   | OKB2288  | OKV2288   |   |  |
| 2200X800X1000  | OKB228A  | OKV228A   |   |  |
| 2200X1000X400  | OKB22A4  | OKV22A4   |   |  |
| 2200X1000X500  | OKB22A5  | OKV22A5   |   |  |
| 2200X1000X600  | OKB22A6  | OKV22A6   |   |  |
| 2200X1000X800  | OKB22A8  | OKV22A8   |   |  |
| 2200X1000X1000 | OKB22AA  | OKV22AA   |   |  |
| 2200X1200X400  | OKB22C4  | OKV22C4   |   |  |
| 2200X1200X500  | OKB22C5  | OKV22C5   |   |  |
| 2200X1200X600  | OKB22C6  | OKV22C6   |   |  |
| 2200X1200X800  | OKB22C8  | OKV22C8   |   |  |
| 2200X1200X1000 | OKB22CA  | OKV22CA   |   |  |
| 2200X1400X500  | OKB22D5  |   |   |  |
| 2200X1400X600  | OKB22D6  |   |   |  |
| 2200X1400X800  | OKB22D8  |   |   |  |
| 2200X1600X500  | OKB22E5  |   |   |  |
| 2200X1600X600  | OKB22E6  |   |   |  |
| 2200X1600X800  | OKB22E8  |   |   |  |

Note: for more information on the characteristic dimensions of enclosures OKV pag. 31; OKR, pag. 33, OKD, pag. 38